

Confidential

EPSON

One-Station Printer

TM-U220 series

Specification

STANDARD	
Rev. No.	B
Notes	

Copied Date	
Copied by	

SEIKO EPSON CORPORATION

MATSUMOTO MINAMI PLANT
2070 KOTOBUKI KOAKA, MATSUMOTO-SHI, NAGANO, 399-8702 JAPAN
PHONE(0263)86-5353 FAX(0263)86-9925

REVISION SHEET

The table below indicates which pages in this specification have been revised.
 Before reading this specification, be sure you have the correct version of each page.

Revisions		Design Section			Sheet Rev. No.						
Rev.	Document	WRT	CHK	APL	Sheet	Rev.	Sheet	Rev.	Sheet	Rev.	
A	Enactment	Nakayama	Ikegami	Nakayama	I	B	19	B	45	B	
B	Change	Ikegami	Nakayama	Nakayama	II	B	20	B	46	B	
					III	B	21	B	47	B	
					IV	B	22	B	48	B	
					V	B	23	B	49	B	
					VI	B	24	B	50	B	
					VII	B	25	B	51	B	
							26	B	52	B	
					1	B	27	B	53	B	
					2	B	28	B	54	B	
					3	B	29	B	55	B	
					4	B	30	B	56	B	
					5	B	31	B	57	B	
					6	B	32	B	58	B	
					7	B	33	B	59	B	
					8	B	34	B	60	B	
					9	B	35	B	61	B	
					10	B	36	B	62	B	
					11	B	37	B	63	B	
					12	B	38	B	64	B	
					13	B	39	B	65	B	
					14	B	40	B	66	B	
					15	B	41	B	67	B	
					16	B	42	B	68	B	
					17	B	43	B	69	B	
					18	B	44	B	70	B	
TITLE TM-U220 series Specification (STANDARD)				Front Part					Contents Appendix Total	Contents Appendix Total	Contents Appendix Total
				Cover	Rev. Sheet	Scope	General Description	Table of Contents			
				1	3	-	3	4			

REVISION SHEET

The table below indicates which pages in this specification have been revised.
 Before reading this specification, be sure you have the correct version of each page.

Revisions		Design Section			Sheet Rev. No.						
Rev.	Document	WRT	CHK	APL	Sheet	Rev.	Sheet	Rev.	Sheet	Rev.	
A	Enactment				71	B	97	B	123	B	
B	Change				72	B	98	B			
					73	B	99	B			
					74	B	100	B	App.1	B	
					75	B	101	B	App.2	B	
					76	B	102	B	App.3	B	
					77	B	103	B	App.4	B	
					78	B	104	B	App.5	B	
					79	B	105	B	App.6	B	
					80	B	106	B	App.7	B	
					81	B	107	B	App.8	B	
					82	B	108	B	App.9	B	
					83	B	109	B	App.10	B	
					84	B	110	B	App.11	B	
					85	B	111	B	App.12	B	
					86	B	112	B	App.13	B	
					87	B	113	B			
					88	B	114	B			
					89	B	115	B			
					90	B	116	B			
					91	B	117	B			
					92	B	118	B			
					93	B	119	B			
					94	B	120	B			
					95	B	121	B			
					96	B	122	B			
TITLE TM-U220 series Specification (STANDARD)				Front Part					Contents	Appendix	Total
				Cover	Rev. Sheet	Scope	General Description	Table of Contents			
				1	3	-	3	4			

REVISION SHEET

REV.	SHEET	CHANGED CONTENTS
B	All	All pages are revised.
	III	Features <ul style="list-style-type: none"> • ... (... , type D) (planned) (added)
	2	1.2 Character Specifications 2) Character structure: Font type (added)
	3	3) Character size: Font type (added)
	12	1.10 Electrical Characteristics 1) Supply voltage: Included AC adapter → Included power supply unit 3) Power consumption Multilingual model: (added) 1.11 EMI and Safety Standards Applied (changed) b) PS-180 (added)
	15	1.14 Printer Installation Position ... (planned) (added)
	54	3.2.21 Page 254 (space page) Note: (deleted)
	55	3.2.22 Page 255 (space page) Note: (deleted)
	77	5.1 Standard Accessories AC adapter → Power supply unit 5.1.1 External size and mass of AC adapter C → External size and mass of Power Supply Unit
	78	5.2 Options <ul style="list-style-type: none"> • Various interface boards ... (added) 5.3 Interface Board (deleted)
	App.1	APPENDIX A: MISCELLANEOUS NOTES 2) Print duty → Print duty control (changed) 3) Print color selection duty (moved from 2))
	App.5	7) Recovery from an autocutter error (changed)
	App.7	APPENDIX B: INSTALLING THE NEAR-END DETECTOR AND ADJUSTING THE AMOUNT OF ROLL PAPER REMAINING ↓ APPENDIX B: ADJUSTING THE AMOUNT OF ROLL PAPER REMAINING
	TITLE	

CONFIDENTIALITY AGREEMENT

BY USING THIS DOCUMENT, YOU AGREE TO ABIDE BY THE TERMS OF THIS AGREEMENT. PLEASE RETURN THIS DOCUMENT IMMEDIATELY IF YOU DO NOT AGREE TO THESE TERMS.

1. This document contains confidential, proprietary information of Seiko Epson Corporation or its affiliates. You must keep such information confidential. If the user is a business entity or organization, you must limit disclosure to your employees, agents, and contractors who have a need to know and who are also bound by obligations of confidentiality.
2. On the earlier of (a) termination of your relationship with Seiko Epson, or (b) Seiko Epson's request, you must stop using the confidential information. You must then return or destroy the information, as directed by Seiko Epson.
3. If a court, arbitrator, government agency, or the like orders you to disclose any confidential information, you must immediately notify Seiko Epson. You agree to give Seiko Epson reasonable cooperation and assistance in resisting disclosure.
4. You may use confidential information only for the purpose of operating or servicing the products to which the document relates, unless you obtain the prior written consent of Seiko Epson for some other use.
5. Seiko Epson warrants that it has the right to disclose the confidential information. SEIKO EPSON MAKES NO OTHER WARRANTIES CONCERNING THE CONFIDENTIAL INFORMATION OR ANY OTHER INFORMATION IN THE DOCUMENT, INCLUDING (WITHOUT LIMITATION) ANY WARRANTY OF TITLE OR NON-INFRINGEMENT. Seiko Epson has no liability for loss or damage arising from or relating to your use of or reliance on the information in the document.
6. You may not reproduce, store or transmit the confidential information in any form or by any means (electronic, mechanical, photocopying, recording, or otherwise) without the prior written permission of Seiko Epson.
7. Your obligations under this Agreement are in addition to any other legal obligations. Seiko Epson does not waive any right under this Agreement by failing to exercise it. The laws of Japan apply to this Agreement.

CAUTIONS

1. This document shall apply only to the product(s) identified herein.
2. No part of this document may be reproduced, stored in a retrieval system, or transmitted in any form or by any means, electronic, mechanical, photocopying, recording, or otherwise, without the prior written permission of Seiko Epson Corporation.
3. The contents of this document are subject to change without notice. Please contact us for the latest information.
4. While every precaution has been taken in the preparation of this document, Seiko Epson Corporation assumes no responsibility for errors or omissions.
5. Neither is any liability assumed for damages resulting from the use of the information contained herein.
6. Neither Seiko Epson Corporation nor its affiliates shall be liable to the purchaser of this product or third parties for damages, losses, costs, or expenses incurred by the purchaser or third parties as a result of accident, misuse, or abuse of this product or unauthorized modifications, repairs, or alterations to this product, or (excluding the U. S.) failure to strictly comply with Seiko Epson Corporation's operating and maintenance instructions.
7. Seiko Epson Corporation shall not be liable against any damages or problems arising from the use of any options or any consumable products other than those designated as Original EPSON Products or EPSON Approved Products by Seiko Epson Corporation.

TRADEMARKS

EPSON® and ESC/POS® are registered trademarks of Seiko Epson Corporation.

General Notice: Other product and company names used herein are for identification purposes only and may be trademarks of their respective companies.

EPSON	TITLE TM-U220 series Specification (STANDARD)	SHEET REVISION B	NO.	
			NEXT II	SHEET I

General Description

This specification applies to the TM-U220 series.

Model type		Two-color printing	Autocutter installed	Take-up device installed	Paper width (mm)	Printable characters	Interface
A	ANK model	Yes	Yes	Yes	76	ANK	Serial / Parallel
	Multilingual model (*1)	Yes	Yes	Yes	76	ANK + Multilingual characters	Serial / Parallel
B	ANK model	Yes	Yes	--	76 / 69.5 / 57.5	ANK	Serial / Parallel
	Multilingual model (*1)	Yes	Yes	--	76 / 69.5 / 57.5	ANK + Multilingual characters	Serial / Parallel
D	ANK model	Yes	--	--	76 / 69.5 / 57.5	ANK	Serial / Parallel
	Multilingual model (*1)	Yes	--	--	76 / 69.5 / 57.5	ANK + Multilingual characters	Serial / Parallel

ANK = alphanumeric characters

NOTES:*1: Multilingual model is the printer that can print with any one of the following: Japanese Kanji, Simplified Chinese, Traditional Chinese, Thai characters, or Korean characters.

This specification describes only the outline of the general functions and the model-dependent functions of the commands. For detailed specifications and usage of the commands, please refer to the ESC/POS APG (Application Programming Guide) that is separately issued.

EPSON	TITLE TM-U220 series Specification (STANDARD)	SHEET REVISION B	NO.	
			NEXT III	SHEET II

Features

This printer was developed on the basis of the high performance/low-cost ratio design concept.

This printer is a one-station printer that is light and offers excellent reliability. The design of this printer also emphasizes the satisfaction of user needs.

The printer has the following features:

<General>

- Compact and lightweight.
- Excellent reliability and long life due to adoption of a stepping motor both for moving the carriage and for paper feeding.
- AC adapter provides a compact power supply.
- Can be installed hanging on the wall with an optional hanging bracket (for type B/D). (planned)

<Printing>

- Print speed: 4.7 lps (for 40 columns, with 16 cpi)
 [lps: line per second]
 [cpi: characters per 25.4 mm {1"}]
- High-speed printing through logic-seeking control
- Two-color printing (black and red)
- Can print on various paper wide range (for type B or D: 76 / 69.5 / 57.5 mm)
- Selectable character fonts (7 × 9, 9 × 9)
- Flexible paper feed pitch setting permits printing of any user-defined format.

<Printer handling>

- Easy drop-in paper loading and easy maintenance
- Cable connectors are housed in the bottom of the printer.
- Built-in two drawer kickout interface connectors
- Built-in autocutter (for type A/B)
- Built-in take-up device (for type A)

<Software>

- Command protocol is based on the ESC/POS[®] proprietary command system.
- OPOS ADK and Windows[®] printer driver are available.
- Automatic status back (ASB) function that automatically transmits changes in printer status.

EPSON	TITLE TM-U220 series Specification (STANDARD)	SHEET REVISION B	NO.	
			NEXT IV	SHEET III

TABLE OF CONTENTS

1.	BASIC SPECIFICATIONS	1
1.1	Printing Specifications	1
1.2	Character Specifications	2
1.3	Ribbon Cassette	4
1.4	Roll Paper Supply Unit	6
1.5	Paper Specifications	7
1.6	Takeup Device (for Type A)	7
1.7	Autocutter (for Type A/B)	8
1.8	Printable Area	9
1.9	Internal Buffer	11
1.10	Electrical Characteristics	12
1.11	EMI and Safety Standards Applied	12
1.12	Reliability	13
1.13	Environmental Specifications	14
1.14	Printer Installation Position	15
2.	CONFIGURATION	16
2.1	Interface Specifications	16
2.1.1	RS-232 serial interface	16
2.1.2	IEEE 1284 Bidirectional Parallel Interface (Parallel Interface Specifications)	22
2.2	Connectors	28
2.2.1	Interface connectors	28
2.2.2	Power supply connector	29
2.2.3	Drawer kick-out connector (modular connector)	29
3.	FUNCTIONS	32
3.1	Commands	32
3.1.1	List of commands for all printer models	32
3.1.2	List of commands for the Japanese, Simplified Chinese, Traditional Chinese, and Korean models	33
3.1.3	Obsolete commands	33
3.2	Character Code Tables	34
3.2.1	Page 0 (PC437: U.S.A. Standard Europe) (International character set: U.S.A.)	34
3.2.2	Page 1 (Katakana)	35
3.2.3	Page 2 (PC850: Multilingual)	36
3.2.4	Page 3 (PC860: Portuguese)	37
3.2.5	Page 4 (PC863: Canadian-French)	38
3.2.6	Page 5 (PC865: Nordic)	39
3.2.7	Page 6 (Hiragana) (Available on the Japanese model)	40
3.2.8	Page 7 (One-pass printing Kanji characters) (Available on the Japanese model)	41
3.2.9	Page 8 (One-pass printing Kanji characters) (Available on the Japanese model)	42
3.2.10	Page 16 (WPC1252)	43
3.2.11	Page 17 (PC866: Cyrillic #2)	44
3.2.12	Page 18 (PC852: Latin2)	45
3.2.13	Page 19 (PC858:Euro)	46
3.2.14	Page 20 (Thai Character Code 42)	47
3.2.15	Page 21 (Thai Character Code 11)	48
3.2.16	Page 22 (Thai Character Code 13)	49
3.2.17	Page 23 (Thai Character Code 14)	50
3.2.18	Page 24 (Thai Character Code 16)	51
3.2.19	Page 25 (Thai Character Code 17)	52
3.2.20	Page 26 (Thai Character Code 18)	53

EPSON	TITLE	SHEET REVISION	NO.	
	TM-U220 series Specification (STANDARD)	B	NEXT V	SHEET IV

Confidential

3.2.21 Page 254 (space page)	54
3.2.22 Page 255 (space page)	55
3.2.23 International character sets	56
3.3 Switches and Buttons	57
3.3.1 Power button.....	57
3.3.2 Panel buttons	57
3.3.3 DIP switches	58
3.3.4 Memory switches	63
3.4 Panel LED Indicators	65
3.4.1 Panel LED indicators	65
3.5 Error Processing	66
3.5.1 Error types	66
3.5.2 Operation when an error is detected	67
3.5.3 Data reception error.....	67
3.6 Self-test.....	68
3.7 Hexadecimal Dumping.....	69
3.8 Memory Switch Setting Mode	70
3.9 Paper Sensors	71
3.9.1 Sensors and LED indicators	71
3.9.2 Sensors and printing.....	71
3.10 Buffer-full Printing	71
3.11 Roll Paper Cover Open Lever.....	71
3.12 Roll Paper Cover Open Sensor	72
4. CASE SPECIFICATIONS.....	73
4.1 External Dimensions and Mass	73
4.2 Color	73
4.3 External Appearance	74
5. OPTIONS AND CONSUMABLES	77
5.1 Standard Accessories	77
5.1.1 External size and mass of Power Supply Unit.....	77
5.2 Options.....	78
6. COMMANDS	79
6.1 Command Notation	78
6.2 Explanation of Terms.....	80
6.3 Control Commands	81
HT	81
LF.....	81
CR.....	81
DLE EOT <i>n</i>	82
DLE ENQ <i>n</i>	84
DLE DC4 <i>fn m t</i> (<i>fn = 1</i>)	84
ESC SP <i>n</i>	85
ESC ! <i>n</i>	85
ESC % <i>n</i>	86
ESC & <i>y c1 c2 [x1 d1...d(y×x1)]...[xk d1...d(y×xk)]</i>	86
ESC * <i>m nL nH d1...dk</i>	87
ESC - <i>n</i>	87
ESC 2	87
ESC 3 <i>n</i>	88

EPSON	TITLE	SHEET REVISION	NO.	
	TM-U220 series Specification (STANDARD)		B	NEXT VI

Confidential

ESC <	88
ESC = <i>n</i>	88
ESC ? <i>n</i>	89
ESC @	89
ESC D <i>n</i> 1... <i>nk</i> NUL	89
ESC E <i>n</i>	90
ESC G <i>n</i>	90
ESC J <i>n</i>	90
ESC K <i>n</i>	91
ESC M <i>n</i>	91
ESC R <i>n</i>	92
ESC U <i>n</i>	92
ESC a <i>n</i>	93
ESC c 3 <i>n</i>	93
ESC c 4 <i>n</i>	94
ESC c 5 <i>n</i>	94
ESC d <i>n</i>	95
ESC e <i>n</i>	95
ESC p <i>m</i> <i>t</i> 1 <i>t</i> 2	96
ESC r <i>n</i>	96
ESC t <i>n</i>	97
ESC { <i>n</i>	98
FS p <i>n</i> <i>m</i>	98
FS q <i>n</i> [<i>xL</i> <i>xH</i> <i>yL</i> <i>yH</i> <i>d</i> 1... <i>dk</i>]1 ... [<i>xL</i> <i>xH</i> <i>yL</i> <i>yH</i> <i>d</i> 1... <i>dk</i>] <i>n</i>	99
GS (A <i>pL</i> <i>pH</i> <i>n</i> <i>m</i>	100
GS (C <i>pL</i> <i>pH</i> <i>m</i> <i>fn</i> <i>b</i> [<i>c</i> 1 <i>c</i> 2] [<i>d</i> 1... <i>dk</i>]	101
<Function 0> GS (C <i>pL</i> <i>pH</i> <i>m</i> <i>fn</i> <i>b</i> <i>c</i> 1 <i>c</i> 2 (<i>fn</i> = 0, 48)	102
<Function 1> GS (C <i>pL</i> <i>pH</i> <i>m</i> <i>fn</i> <i>b</i> <i>c</i> 1 <i>c</i> 2 <i>d</i> 1... <i>dk</i> (<i>fn</i> = 1, 49)	102
<Function 2> GS (C <i>pL</i> <i>pH</i> <i>m</i> <i>fn</i> <i>b</i> <i>c</i> 1 <i>c</i> 2 (<i>fn</i> = 2, 50)	103
<Function 3> GS (C <i>pL</i> <i>pH</i> <i>m</i> <i>fn</i> <i>b</i> (<i>fn</i> = 3, 51)	103
<Function 4> GS (C <i>pL</i> <i>pH</i> <i>m</i> <i>fn</i> <i>b</i> (<i>fn</i> = 4, 52)	103
<Function 5> GS (C <i>pL</i> <i>pH</i> <i>m</i> <i>fn</i> <i>b</i> (<i>fn</i> = 5, 53)	104
<Function 6> GS (C <i>pL</i> <i>pH</i> <i>m</i> <i>fn</i> <i>b</i> <i>d</i> 1 <i>d</i> 2 <i>d</i> 3 (<i>fn</i> = 6, 54)	104
GS (D <i>pL</i> <i>pH</i> <i>m</i> [<i>a</i> 1 <i>b</i> 1]...[<i>a</i> k <i>b</i> k]	105
GS (E <i>pL</i> <i>pH</i> <i>fn</i> [<i>parameters</i>]	106
<Function 1> GS (E <i>pL</i> <i>pH</i> <i>fn</i> <i>d</i> 1 <i>d</i> 2 (<i>fn</i> = 1)	107
<Function 2> GS (E <i>pL</i> <i>pH</i> <i>fn</i> <i>d</i> 1 <i>d</i> 2 <i>d</i> 3 (<i>fn</i> = 2)	107
<Function 3> GS (E <i>pL</i> <i>pH</i> <i>fn</i> [<i>a</i> 1 <i>b</i> 18... <i>b</i> 11]...[<i>a</i> k <i>b</i> k8... <i>b</i> k1] (<i>fn</i> = 3)	108
<Function 4> GS (E <i>pL</i> <i>pH</i> <i>fn</i> <i>a</i> (<i>fn</i> = 4)	109
<Function 5> GS (E <i>pL</i> <i>pH</i> <i>fn</i> [<i>a</i> 1 <i>n</i> 1L <i>n</i> 1H]...[<i>a</i> k <i>n</i> kL <i>n</i> kH] (<i>fn</i> = 5)	109
<Function 6> GS (E <i>pL</i> <i>pH</i> <i>fn</i> <i>a</i> (<i>fn</i> = 6)	110
<Function 11> GS (E <i>pL</i> <i>pH</i> <i>fn</i> <i>a</i> <i>d</i> 1... <i>dk</i> (<i>fn</i> = 11)	110
<Function 12> GS (E <i>pL</i> <i>pH</i> <i>fn</i> <i>a</i> (<i>fn</i> = 12)	111
GS I <i>n</i>	112
<A> GS V <i>m</i>	113
 GS V <i>m</i> <i>n</i>	113
GS a <i>n</i>	114
GS r <i>n</i>	116
6.4 Multi-byte code characters commands list	117
FS ! <i>n</i>	117
FS &	117
FS - <i>n</i>	118
FS	118

EPSON	TITLE	SHEET REVISION	NO.	
	TM-U220 series Specification (STANDARD)	B	NEXT VII	SHEET VI

Confidential

FS 2 c1 c2 [d1...dk].....	119
FS ? c1 c2	120
FS C n.....	120
FS S n1 n2.....	121
FS W n.....	121
6.4 Obsolete Commands	122
ESC I [obsolete command]	122
ESC m [obsolete command]	122
ESC u n [obsolete command]	123
ESC v [obsolete command]	123
APPENDIX A: MISCELLANEOUS NOTES	App.1
APPENDIX B: ADJUSTING THE AMOUNT OF ROLL PAPER REMAINING	App.6
APPENDIX C: ROLL PAPER SETUP.....	App.7
APPENDIX D: NOTES ON CHARACTER PRINTING.....	App.8
APPENDIX E: NOTES ON USING THE DRAWER KICK-OUT CONNECTOR.....	App.10
APPENDIX F: CHANGING THE PAPER GUIDE SPACER	App.13

EPSON	TITLE TM-U220 series Specification (STANDARD)	SHEET REVISION B	NO.	
			NEXT 1	SHEET VII

1. BASIC SPECIFICATIONS

1.1 Printing Specifications

- 1) Printing method: Serial impact dot matrix
- 2) Head wire configuration: 9-pin serial configuration
- 3) Printing directions: Bi-directional printing (logic seeking)
- 4) Printing speed: Approximately 4.7 lps
(printing 40 columns per line with 16 cpi, at 1/6" line spacing)
Approximately 6.0 lps
(printing 30 columns per line with 16 cpi, at 1/8" line spacing)
Approximately 8.8 lps
(printing 16 columns per line with 16 cpi, at 1/6" line spacing)
(except data transmission and processing time)
[lps: lines per second]
[cpi: characters per 25.4 mm {1"}]

NOTES: 1. If the printing duty ratio is too high, the operation of the print head is stopped intermittently by the duty limit. In such circumstances, the printing speeds shown above cannot be guaranteed.

2. When red-color or 2-color (black/red) combination printing is selected in a 2-color print model, the printing speed is less than the black-color printing speed. This is caused by the switching operation in the printer.

- 5) Printable area: Depending on the paper width and the DIP switch 2-1 setting as follows:

Paper width	DIP SW2-1 setting	
	Off	On
76 mm	400 half dots	385 half dots
69.5 mm	360 half dots	360 half dots
57.5 mm	300 half dots	297 half dots

- 6) Characters per line: Refer to Table 1.2.1.
- 7) Characters per inch: Refer to Table 1.2.1.
- 8) Printing duty ratio: Refer to Appendix A.
- 9) Two-color printing (2-color print model only): Black and red colors are selectable.

EPSON	TITLE TM-U220 series Specification (STANDARD)	SHEET REVISION B	NO.	
			NEXT 2	SHEET 1

1.2 Character Specifications

1) Number of characters:

Alphanumeric characters: 95
 Extended graphics: 128 × 12 tables
 (15 tables for Japanese model)
 International characters: 48

The multilingual model supports printing with one of the following characters:

- ① Japanese Kanji (Two-pass printing font)
 6879 (JIS X0208-1990)
 Special font: 83

Code System	Number of characters	JIS Code	Shift JIS Code
Special	83	2D-21 ~ 2D-7E	87-40 ~ 87-9D

- ② Simplified Chinese (Two-pass printing font)
 28553 (GB18030-2000)
- ③ Traditional Chinese (Two-pass printing font)
 13494 (Big 5)
- ④ Thai character (3-pass printing font)
 128 characters × 7 pages (133 character types)
- ⑤ Korean Kanji (Two-pass printing font)
 8366 (KS C5601 type)

2) Character structure:

Font B: 7 × 9
 Font A: 9 × 9
 Kanji: 16 × 16 (Multilingual model)
 Thai: 7 × 27 (Multilingual model)
 Thai: 9 × 27 (Multilingual model)

EPSON	TITLE TM-U220 series Specification (STANDARD)	SHEET REVISION B	NO.	
			NEXT 3	SHEET 2

3) Character size: Refer to Table 1.2.1

Table 1.2.1 Character Dimensions, Characters Per Inch, Characters Per Line

Character configuration		Character dimensions W × H (mm)	Dot spacing between characters	Paper width (mm) and Characters per line (cpi)			Characters per 25.4 mm {1"}(cpi)
				76	69.5	57.5	
Font B (7 × 9)	ANK	1.2 × 3.1	3 half dots	40	36	30	16
	Graphics	1.7 × 3.1	0				
Font A (9 × 9)	ANK	1.6 × 3.1	3 half dots	33	30	25	13.3
	Graphics	2.0 × 3.1	0				
Font B (7 × 9)	ANK	1.2 × 3.1	2 half dots	42	40	33	17.8
	Graphics	1.6 × 3.1	0				
Font A (9 × 9)	ANK	1.6 × 3.1	2 half dots	35	32	27	14.5
	Graphics	1.9 × 3.1	0				
Kanji (16 × 16)	Kanji	2.7 × 2.7	0	25	22	18	9.5
			2 (*1)	22	20	16	8.9
Thai (7 × 27)	Thai characters	1.2 × 9.5	3 half dots	40	36	30	16
Thai (9 × 27)	Thai characters	1.6 × 9.5	3 half dots	33	30	25	13.3
Thai (7 × 27)	Thai characters	1.2 × 9.5	2 half dots	42	40	33	17.8
Thai (9 × 27)	Thai characters	1.6 × 9.5	2 half dots	35	32	27	14.5

ANK = Alphanumeric characters

(*1) Selectable by software command (default value is 2)

- NOTES:
- The default font is font B (7 × 9).
 - The dot spacing between characters for 2 half-dots or 3 half-dots can be set by changing the DIP switch 2-1.

Example: Font B (7 × 9) (with three-dot spacing)

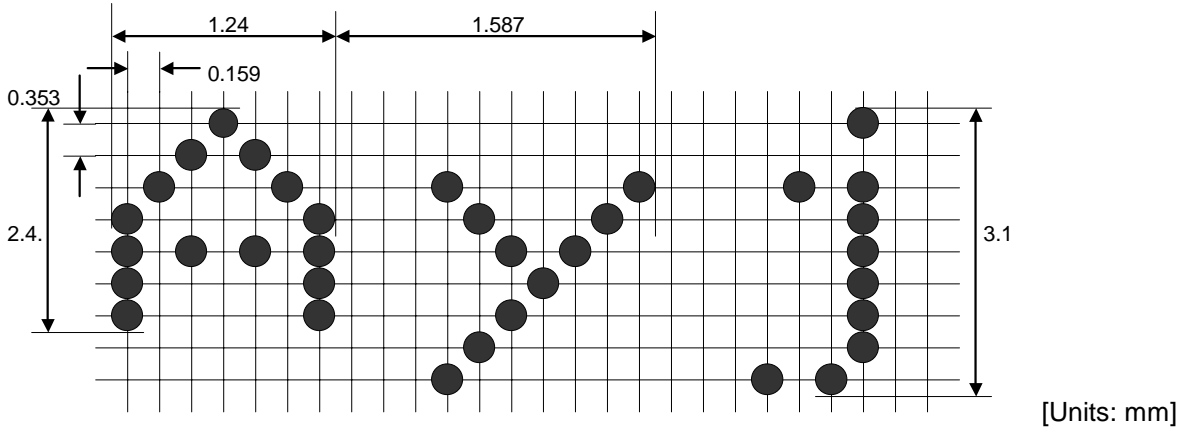

Figure 1.2.1 Font B (7 × 9)

EPSON	TITLE	SHEET REVISION	NO.	
	TM-U220 series Specification (STANDARD)	B	NEXT 4	SHEET 3

1.3 Ribbon Cassette

1) Special ribbon cassettes

Model No.	Color	Ribbon life (*1)
ERC-38 (P)	Purple	4 million characters (with continuous printing at 25°C {77°F})
ERC-38 (B)	Black	3 million characters (with continuous printing at 25°C {77°F})
ERC-38 (B/R)	Black/Red	Black: 1.5 million characters (with continuous printing at 25°C {77°F}) Red: 750,000 characters (with continuous printing at 25°C {77°F})

*1: The ribbon life is based on the following conditions:

- Character font: 7 × 9 font (with descenders)
 - Printing pattern: ASCII 96-character rolling pattern
- Refer to the printing example for the printing pattern
 ERC-38 (P)/(B): Appendix Figure A.1
 ERC-38 (B/R): Appendix Figure A.2

2) External view of ribbon cassette:

Refer to Figure. 1.3.1.

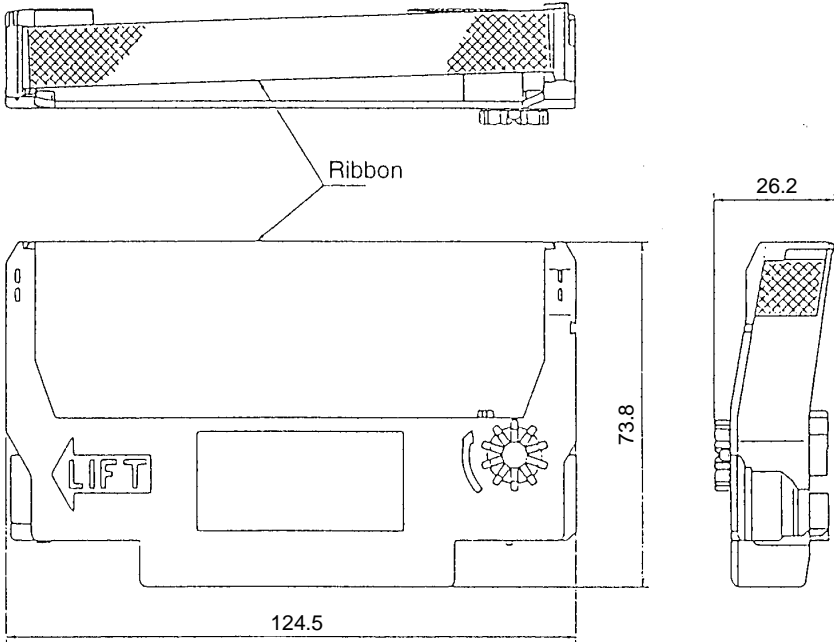

[Units: mm]

Figure 1.3.1 External View of ERC-38 (P)/(B)

NOTE: Malfunctions and other problems may arise if a ribbon other than the specified ribbon cassette is used. Seiko Epson does not warrant against problems arising from the use of ribbons other than the specified one.

EPSON	TITLE	TM-U220 series Specification (STANDARD)	SHEET REVISION	NO.	
			B	NEXT 5	SHEET 4

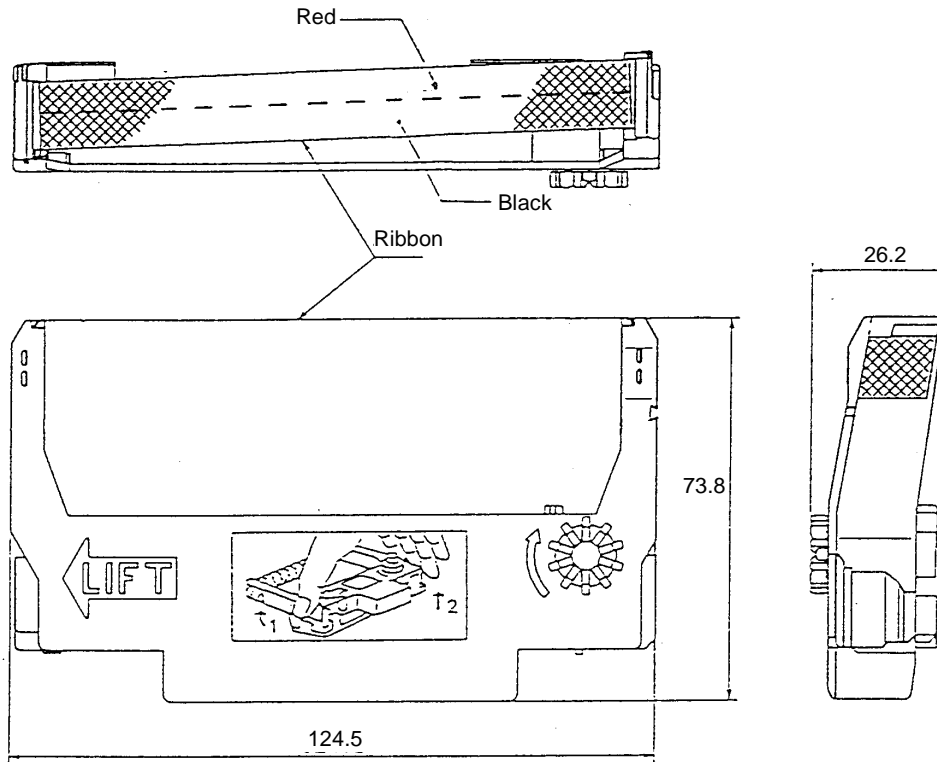

[Units: mm]

Figure 1.3.2 External View of ERC-38 (B/R)

NOTE: Malfunctions and other problems may arise if a ribbon other than the specified ribbon cassette is used. Seiko Epson does not warrant against problems arising from the use of ribbons other than the specified one.

EPSON	TITLE	TM-U220 series Specification (STANDARD)	SHEET REVISION	NO.	
			B	NEXT 6	SHEET 5

Confidential

1.4 Roll Paper Supply Unit

- 1) Supply method: Drop-in method
- 2) End sensor
 - a) Detection method: By mechanical microswitch
 - b) Detection position: Positioned within the paper path for the roll paper; detects the end of the roll paper
- 3) Near end sensor: Installed in the case unit (factory option)
 - a) Detection method: By mechanical microswitch
 - b) Inner diameter of the roll paper core: 10.5 to 12.5 mm (Refer to Appendix B for details.)

NOTE: The standard version of this printer is not equipped with a mechanism that detects the amount of roll paper remaining (a near-end sensor). Roll papers may jam if the roll paper core and paper are attached to each other by tape or glue. Because of this, be sure the printer detects the amount of roll paper remaining with the optional near-end sensor when the paper is attached to the core by tape or glue, or exchange the roll paper with the new one before the current roll paper is finished by checking the end mark.

- 4) Paper width selection
The paper width can be selected using the roll paper spacer (only for the type B or D).
76 mm / 69.5 mm / 57.5 mm {3.00"/2.74"/2.26"}

EPSON	TITLE TM-U220 series Specification (STANDARD)	SHEET REVISION B	NO.	
			NEXT 7	SHEET 6

Confidential

1.5 Paper Specifications

- 1) Paper feeding method: Friction feed
- 2) Paper feed interval: Initial setting: Approximately 4.23 mm {1/6"}
Can be set in units of approximately 0.18 mm {1/144"} by command.
- 3) Paper feed speed: 30 lps {approximately 4.99"/s}
(during continuous feeding)
[lps: lines per second]
- 4) Paper dimensions:
- a) Roll paper
- Width 76 ± 0.5 mm { 3 ± 0.02 "} / 69.5 ± 0.5 mm { 2.74 ± 0.02 "}
/ 57.5 ± 0.5 mm { 2.26 ± 0.02 "}
- Maximum diameter 83 mm {3.27"}
Core When there is no near-end sensor, always be sure to use a roll paper that is not glued to the core
- ① Normal paper
- Paper thickness 1 sheet 0.06 to 0.085 mm {0.0024 to 0.0033"}
Weight 52.3 to 64 g/m² {14 to 17 lb}
(45 to 55 kg/1000 sheets/1091 x 788 mm)
- ② Normal paper
- Number of copies Original 1 sheet + one copy sheet
Thickness 0.05 to 0.08 mm {0.002 to 0.0031"} (thickness of one sheet);
combined, total thickness must be 0.14 mm {0.0055"} or less
- Recommended paper Paper by Mitsubishi - Carbonless paper (blue)
Top and middle sheets N40Hi (paper thickness: 0.06 mm {0.0024"},
mass: 47.2 g/m² {12.6 lb})
Bottom sheet N60 (paper thickness: 0.08 mm {0.0031"},
mass: 68.0 g/m² {18 lb})
- The copying capability is affected by the ambient temperature, and is guaranteed for the temperature ranges shown in 5 - 50°C {41 - 122°F}.

1.6 Takeup Device (for Type A)

A takeup device automatically takes the roll paper up in connection with a paper feed motor.

EPSON	TITLE TM-U220 series Specification (STANDARD)	SHEET REVISION B	NO.	
			NEXT 8	SHEET 7

Confidential

1.7 Autocutter (for Type A/B)

- | | |
|-------------------|---|
| 1) Cutting method | By separated-blade scissors |
| 2) Cutting type | Partial cut (one point left uncut) by factory setting
Full cut (completely cut off) is also possible by dealer setting
(The cutting type is changed by moving the position of the autocutter unit.) |

NOTES:

- It is recommended to feed approximately 2.116 mm or more in advance for printing to prevent dot displacement after cutting.
- Changing partial cut or full cut is not controlled by a software command.
- The cutting type (partial cut or full cut) must be selected before the printer is first used. If the cutting type is changed from partial cut to full cut after the printer has been used, the printer may not be reliable because the wear-out level of the cutter blade differs.

<Prohibited matters>

- When the paper is cut completely (full cut) with the printer's horizontal installation, make sure to remove the cut paper, then perform the next cut. Never remain several pieces of the cut paper in the paper exit. Otherwise, double cut, paper jams, or autocutter error may occur because the cut paper drops into the paper path.

EPSON	TITLE TM-U220 series Specification (STANDARD)	SHEET REVISION B	NO.	
			NEXT 9	SHEET 8

1.8 Printable Area

- 1) Roll paper width and printable area
- ① For paper width 76 mm

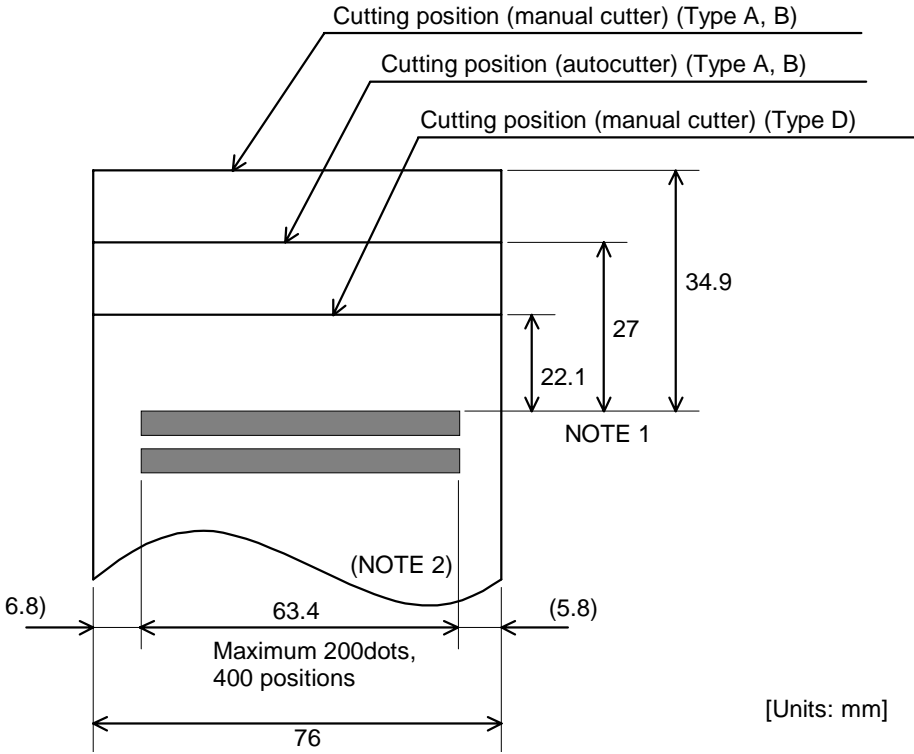

[Units: mm]

Left margin: 6.8 mm
 Right margin: 5.8 mm
 Printable area: 63.4 mm (Maximum 200 dots, 400 positions)

- NOTES: 1. The values shown in the figures are the distance between the manual cutter and the print position.
 2. The values shown for the printing area in the figure are the values calculated (between dot centers) based on the wire diameter (0.29 mm {0.0011"}).

Figure 1.8.1 Printable Area for Paper Width 76 mm

EPSON	TITLE	SHEET REVISION	NO.	
	TM-U220 series Specification (STANDARD)	B	NEXT 10	SHEET 9

② For paper width 69.5 mm (For Type B and D)

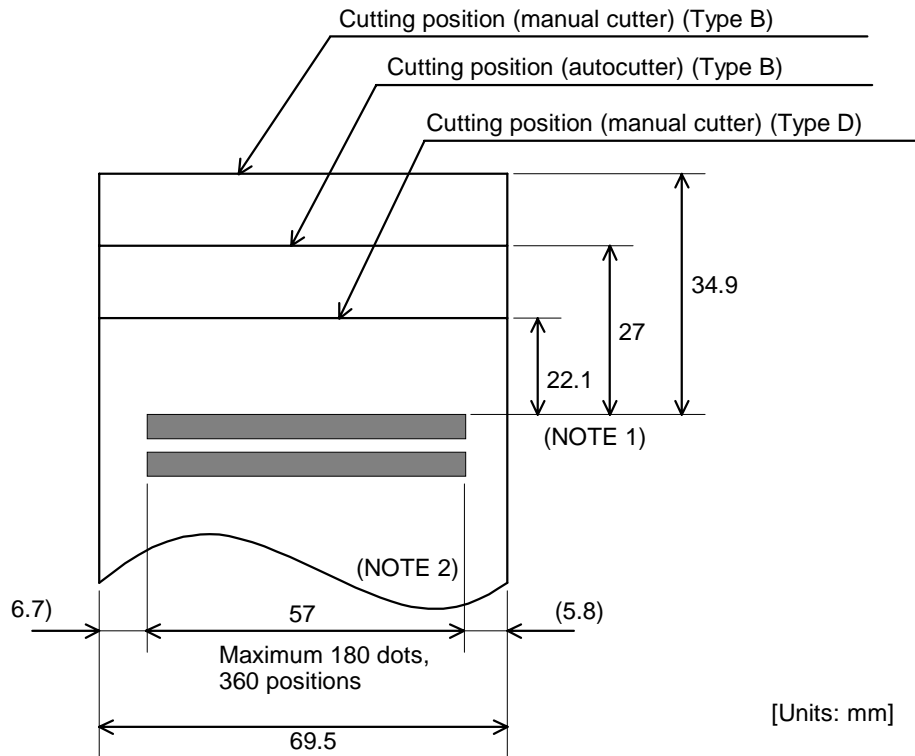

[Units: mm]

Left margin: 6.7 mm
 Right margin: 5.8 mm
 Printable area: 57 mm (Maximum 180 dots, 360 positions)

- NOTES: 1. The values shown in the figures are the distance between the manual cutter and the print position.
 2. The values shown for the printing area in the figure are the values calculated (between dot centers) based on the wire diameter (0.29 mm {0.0011"}).

Figure 1.8.2 Printable Area for Paper Width 69.5 mm

EPSON	TITLE TM-U220 series Specification (STANDARD)	SHEET REVISION B	NO.	
			NEXT 11	SHEET 10

Confidential

③ For paper width 57.5 mm (For Type B and D)

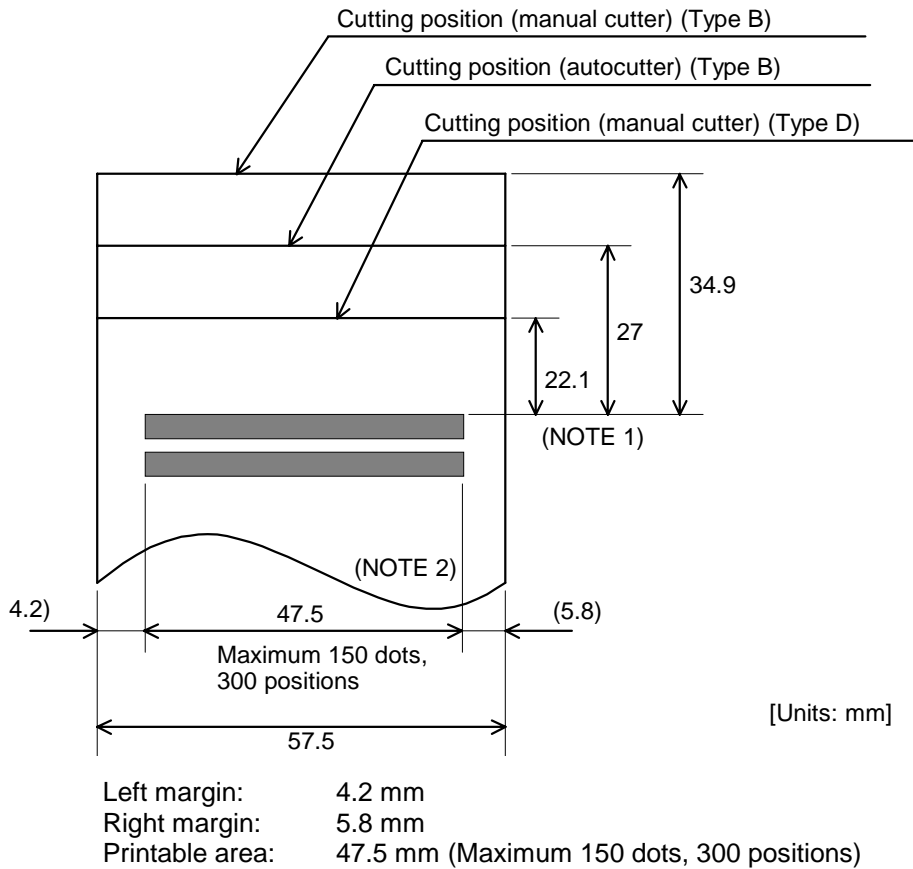

NOTES: 1. The values shown in the figures are the distance between the manual cutter and the print position.
 2. The values shown for the printing area in the figure are the values calculated (between dot centers) based on the wire diameter (0.29 mm {0.0011"}).

Figure 1.8.3 Printable Area for Paper Width 57.5 mm

1.9 Internal Buffer

- 1) Receive buffer Selectable as 4KB or 40 bytes using a DIP switch 1-2
- 2) NV (Non-volatile) bit image data area:
 128KB
- 3) User NV memory: 8KB

<h1>EPSON</h1>	TITLE TM-U220 series Specification (STANDARD)	SHEET REVISION B	NO. 	
			NEXT 12	SHEET 11

1.10 Electrical Characteristics

1) Supply voltage: Included power supply unit
ANK model: AC adapter C
Multilingual model: PS-180

2) Operating voltage: +24VDC \pm 7%

3) Power consumption (except while driving the drawer kick-out):
Operating: ANK model: Mean: 31 W
Multilingual model: Mean: 38 W
Standby: Mean: 2.2 W

1.11 EMI and Safety Standards Applied

1) Printer
(EMC is measured using SEIKO EPSON's power supply unit)

Europe: CE Marking: Directive 89/336/EEC
EN55022 Class B
EN55024
IEC61000-4-2
IEC61000-4-3
IEC61000-4-4
IEC61000-4-5
IEC61000-4-6
IEC61000-4-11

Safety: EN60950

North America: EMI: FCC/ICES-003 Class A
Safety: UL60950 / CSA C22.2 No.60950

Japan: EMI: VCCI Class A

Oceania: EMC: AS/NZS3548

Taiwan: EMC: Class B

UL's Conditions of Acceptability

- For use only in or with complete equipment where the acceptability of the combination is determined by Underwriters Laboratories Inc.
- When installed in an end-product, consideration must be given to the following:
This unit is intended to be supplied by SELV circuit only.

EPSON	TITLE TM-U220 series Specification (STANDARD)	SHEET REVISION B	NO.	
			NEXT 13	SHEET 12

Confidential

2) Power supply unit (Packaged)

a) AC adapter C

Europe:	EMC	CE Marking	Directive: 89/336/EEC EN55022 Class B EN61000-3-2 EN61000-3-3 EN55024 IEC 61000-4-2 IEC 61000-4-3 IEC 61000-4-4 IEC 61000-4-5 IEC 61000-4-6 IEC 61000-4-11
---------	-----	------------	--

	Safety: EN60950
North America:	EMI: FCC Class A / ICES-003 Class A Safety: UL60950/CSA C22.2 No.60950
Japan:	EMI: VCCI Class A Safety: Electrical Appliance and Material Control Law
Oceania:	EMC: AS/NZS 3548 Class B Safety: AS/NZS 60950
Poland:	PN-EN60950 / PN-EN 55022
Argentine:	S-Mark
Singapore:	The Singapore Consumer Protection (Safety Requirements)

b) PS-180

The PS-180 meets the same standards as the AC adapter listed above and also meets the following standards:

China:	CCC
Thai:	BSMI
Hong Kong:	Safety IEC60950

1.12 Reliability

1) Life

Mechanism:	7,500,000 lines
Print head:	150 million characters (using an average of 2 dots/wire per character). (The printing pattern is based on Appendix A,1), Print Duty).
Print color switching:	Refer to Appendix A, 1), Print Duty.
Autocutter:	800,000 cuts End of life is defined as the point at which the printer reaches the beginning of the wearout period.

2) MTBF

180,000 hours
Failure is defined as a random failure occurring at the time of the random failure period.

3) MCBF

18,000,000 lines
This is an average failure interval based on failures relating to wearout and random failures up to the life of 7.5 million lines.

EPSON	TITLE	SHEET REVISION	NO.	
	TM-U220 series Specification (STANDARD)	B	NEXT 14	SHEET 13

1.13 Environmental Specifications

- 1) Temperature
 - During operation: 0 to 50°C {41 to 122°F}. (At 34°C {93°F} or higher, there are humidity restrictions; refer to Figure 1.13.1.)
 - During storage: -10 to 50°C {14 to 122°F} (excludes paper and ribbon)
- 2) Humidity
 - During operation: 10 to 90% (no condensation)
 - During storage: 10 to 90% (no condensation; excludes paper and ribbon)

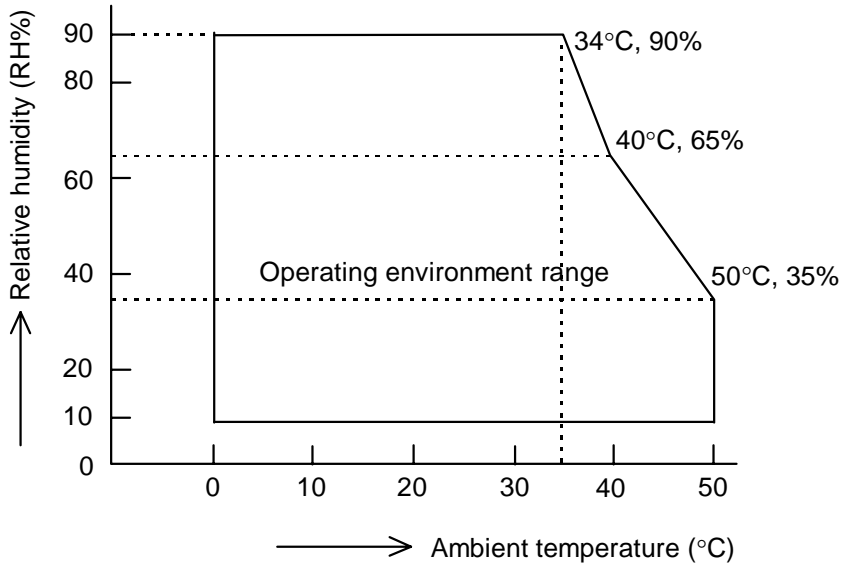

Figure 1.13.1 Operating Temperature and Humidity Range

- 3) Vibration resistance
 - While packed:

Frequency	5 to 55 Hz
Acceleration	Approximately 19.6 m/s ² {2G}
Sweep	10 minutes (half cycle)
Time	One hour
Directions	X, Y and Z
- 4) Impact resistance
 - While packed:

Packaging	Epson's standard packaging
Height	60 cm {2 feet}
Directions	1 corner, 3 edges, 6 sides
 - While not packed:

Height	5 cm {2"}
Directions	4 sides, supported on one side

EPSON	TITLE	SHEET REVISION	NO.	
	TM-U220 series Specification (STANDARD)	B	NEXT 15	SHEET 14

1.14 Printer Installation Position

Install the printer horizontally as a basic position.

The printer also must be installed so that it does not move or vibrate during paper cutting or the drawer kick-out operation. Verco tape is available as an option.

The printer can be also installed on the wall with the optional wall hanging bracket. (for type B/D) (planned)

Follow the instructions in the user's manual, attach the bracket, and install the paper supply box, and change the detection position of the near-end sensor (with installed as a factory option).

EPSON	TITLE TM-U220 series Specification (STANDARD)	SHEET REVISION B	NO.	
			NEXT 16	SHEET 15

2. CONFIGURATION

2.1 Interface Specifications

2.1.1 RS-232 serial interface

2.1.1.1 Specifications

Data transmission:	Serial
Synchronization:	Asynchronous
Handshaking:	DTR/DSR or XON/XOFF control
Signal levels:	MARK = -3 to -15 V ... logic '1' / OFF SPACE = +3 to +15 V ... logic '0' / ON
Data transmission speed:	4800, 9600 bps (Selected with a DIP switch) 1200, 2400, 4800, 9600, 19200 bps (Selected with a memory switch) [bps: bits per second]
Data word length:	7 or 8 bits
Parity:	None, even, odd
Stop bits:	1 or more (Data transmitted from the printer has 1 stop bit (fixed))
Connector:	D-SUB 25 (female) or equivalent

2.1.1.2 Switching between online and offline

The printer does not have an online/offline switch.

The printer goes offline under the following conditions:

- 1) Between when the power is turned on (or the printer reset) and when the printer is ready to receive data.
- 2) During the self-test.
- 3) When the cover is open.
- 4) During paper feeding using the paper FEED button.
- 5) When the printer stops printing due to a paper-end (in cases when an empty paper supply is detected by either the roll paper end sensor or the roll paper near-end sensor with a printing halt feature due to a paper-end set by **ESC c 4**).
- 6) When an error has occurred.

EPSON	TITLE TM-U220 series Specification (STANDARD)	SHEET REVISION B	NO.	
			NEXT 17	SHEET 16

2.1.1.3 Interface connector terminal assignments and signal functions

Interface connector terminal assignments and signal functions are described in Table 2.1.1.

Table 2.1.1 Printer Status and Signals

Pin number	Signal name	Signal direction	Function																													
1	FG	—	Frame ground																													
2	TXD	Output	Transmit data																													
3	RXD	Input	Receive data																													
4	RTS	Output	Same as DTR signal (pin 20)																													
6	DSR	Input	This signal indicates whether the host computer can receive data. SPACE indicates that the host computer can receive data, and MARK indicates that the host computer cannot receive data. When DTR/DSR control is selected, the printer transmits data after confirming this signal. When XON/XOFF control is selected, the printer does not check this signal. Changing DIP switch 2-7 enables this signal to be used as a reset signal for the printer (refer to Section 3.3.3). The printer is reset when the signal remains MARK for 1 ms or more (refer to Section 2.1.1.6).																													
7	SG	—	Signal ground																													
20	DTR	Output	<p>1) When DTR/DSR control is selected, this signal indicates whether the printer is busy. SPACE indicates that the printer is ready to receive data, and MARK indicates that the printer is busy. The busy condition can be changed by using the DIP switch 1-8 as follows:</p> <table border="1" style="width: 100%; border-collapse: collapse;"> <thead> <tr> <th></th> <th>Printer status</th> <th colspan="2">DIP switch 1-8 status</th> </tr> </thead> <tbody> <tr> <td rowspan="8" style="writing-mode: vertical-rl; transform: rotate(180deg); text-align: center;">Offline</td> <td>1. During the period from when the power is turned on (including resetting) to when the printer is ready to receive data.</td> <td>BUSY</td> <td>BUSY</td> </tr> <tr> <td>2. During the self-test.</td> <td>BUSY</td> <td>BUSY</td> </tr> <tr> <td>3. When the cover is open.</td> <td>—</td> <td>BUSY</td> </tr> <tr> <td>4. During paper feeding using the paper FEED button.</td> <td>—</td> <td>BUSY</td> </tr> <tr> <td>5. When the printer stops printing due to a paper-end.</td> <td>—</td> <td>BUSY</td> </tr> <tr> <td>6. When an error occurs.</td> <td>—</td> <td>BUSY</td> </tr> <tr> <td>7. During the memory switch setting mode</td> <td>—</td> <td>BUSY</td> </tr> <tr> <td>8. When the receive buffer becomes full.(*1)</td> <td>BUSY</td> <td>BUSY</td> </tr> </tbody> </table>		Printer status	DIP switch 1-8 status		Offline	1. During the period from when the power is turned on (including resetting) to when the printer is ready to receive data.	BUSY	BUSY	2. During the self-test.	BUSY	BUSY	3. When the cover is open.	—	BUSY	4. During paper feeding using the paper FEED button.	—	BUSY	5. When the printer stops printing due to a paper-end.	—	BUSY	6. When an error occurs.	—	BUSY	7. During the memory switch setting mode	—	BUSY	8. When the receive buffer becomes full.(*1)	BUSY	BUSY
	Printer status	DIP switch 1-8 status																														
Offline	1. During the period from when the power is turned on (including resetting) to when the printer is ready to receive data.	BUSY	BUSY																													
	2. During the self-test.	BUSY	BUSY																													
	3. When the cover is open.	—	BUSY																													
	4. During paper feeding using the paper FEED button.	—	BUSY																													
	5. When the printer stops printing due to a paper-end.	—	BUSY																													
	6. When an error occurs.	—	BUSY																													
	7. During the memory switch setting mode	—	BUSY																													
	8. When the receive buffer becomes full.(*1)	BUSY	BUSY																													

EPSON	TITLE	SHEET REVISION	NO.	
	TM-U220 series Specification (STANDARD)	B	NEXT 18	SHEET 17

Confidential

Pin number	Signal name	Signal direction	Function
			2) When XON/XOFF control is selected: The signal indicates whether the printer is correctly connected and is ready to receive data. SPACE indicates that the printer is ready to receive data. The signal is always SPACE except in the following cases: <ul style="list-style-type: none"> • During the period from when the power is turned on to when the printer is ready to receive data • During the self-test
25	INIT	Input	Changing DIP switch 2-8 enables this signal to be used as a reset signal for the printer. The printer is reset when the signal remains SPACE for 1 ms or more.

*1: • Condition of "receive buffer full":

1) When the receive buffer capacity is specified as 4KB (DIP switch 1-2 is Off (default)):

① When the memory switch 8-7 is Off (default):

When the remaining space in the receive buffer drops to 128 bytes, the printer status becomes "buffer full" and it remains "buffer full" until the space in the receive buffer increases to 256 bytes.

② When the memory switch 8-7 is On:

When the remaining space in the receive buffer drops to 128 bytes, the printer status becomes "buffer full" and it remains "buffer full" until the space in the receive buffer increases to 138 bytes.

2) When the receive buffer capacity is specified as 40 bytes (DIP switch 1-2 is On):

Regardless of the memory switch 8-7, when the remaining space in the receive buffer drops to 16 bytes, the printer status becomes "buffer full" and it remains "buffer full" until the space in the receive buffer increases to 26 bytes.

- The printer ignores the data received when the remaining space in the receive buffer is 0 bytes.

EPSON	TITLE TM-U220 series Specification (STANDARD)	SHEET REVISION B	NO.	
			NEXT 19	SHEET 18

2.1.1.4 XON/OFF transmission timing

When XON/XOFF control is selected, the printer transmits XON or XOFF signals as follows. Transmission timing differs depending on the DIP switch 1-8.

Table 2.1.2 XON/XOFF Transmission Timing

	Printer status	DIP switch 1-8 status	
		ON	OFF
XON transmission	① When the printer goes online after turning on the power or reset	Transmit	Transmit
	② When the receive buffer is released from the buffer full state	Transmit	Transmit
	③ When the printer switches from offline to online	—	Transmit
	④ When the printer recovers from an error using the DLE ENQ 1 or DLE ENQ 2 commands	—	Transmit
XOFF Transmission	⑤ When the receive buffer becomes full	Transmit	Transmit
	⑥ When the printer switches from online to offline	—	Transmit

- NOTES:
- The XON code is <11>H and the XOFF code is <13>H.
 - In case ③, XON is not transmitted when the receive buffer is full.
 - In case ⑥, XOFF is not transmitted when the receive buffer is full.
 - When the DIP switch 1-8 is set to OFF, XON is not transmitted if the printer is in offline state in case ②.

2.1.1.5 Example serial interface connection

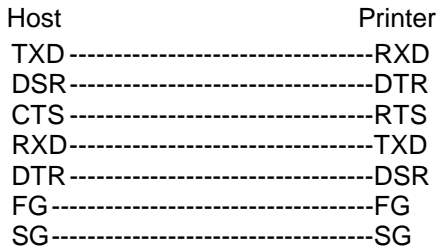

- NOTES:
- When connecting the printer to a DCE (DCE: Data Circuit Terminating Equipment), set the handshaking so that the transmitted data can be received.
 - Transmit data to the printer after turning on the power and initializing the printer.

EPSON	TITLE	SHEET REVISION	NO.	
	TM-U220 series Specification (STANDARD)	B	NEXT 20	SHEET 19

2.1.1.6 Notes on setting the handshake operation with DIP switch 1-8

- 1) The printer mechanism stops but does not become busy when: an error has occurred, printing stops due to a paper-end, or paper is fed using the paper FEED button.
- 2) When setting the memory switch to enable handshaking with the printer, be sure to check the printer status using the **GS a** command and the ASB function. In this setting, the default value of *n* for **GS a** is 2. The printer automatically transmits the printer status, depending on online/offline changes.
- 3) When using **DLE EOT**, **DLE ENQ**, and **DLE DC4** be sure that the receive buffer does not become full.

- When using a host that cannot transmit data when the printer is busy:
If an error has occurred, **DLE EOT**, **DLE ENQ**, and **DLE DC4** cannot be used when the printer is busy due to a receive buffer-full state.
- When using a host that can transmit data when the printer is busy:
When the receive buffer becomes full while transmitting bit-image data, and **DLE EOT**, **DLE ENQ**, or **DLE DC4** is used while sending bit-image data, the code is processed as bit-image data. The data transmitted when the receive buffer is full may be lost.

Example: Check the printer status using **GS r** after transmitting each line of data and use the 4KB receive buffer. Transmit data one line at a time so that the receive buffer does not become full.

2.1.1.7 Notes on resetting the printer using the interface

The printer can be reset through the interface (pins 6 or 25) by changing the DIP switch settings accordingly (Refer to Table 3.3.2, DIP Switch 2 and Table 3.3.6, DIP Switch 2).

Table 2.1.3 Switching of the Reset Condition

Pin No.	DIP Switch	Reset Condition
Pin 6 (DSR)	2-7 On	MARK level signal level input
Pin 25 (INIT)	2-8 On	SPACE or TTL-HIGH level voltage signal input

To reset the printer, the conditions given below must be satisfied:

<DC characteristics>

Table 2.1.4 DC Characteristics of the Reset Condition

Item	Symbol	Pin 6 (DSR)	Pin 25 (INIT)
Input HIGH level voltage	V _{IH}	+3 to +15 V	+2 to + 15 V
Input LOW level voltage	V _{IL}	-15 to -3 V	-15 to + 0.8 V
Input HIGH level current	I _{IH}	5 mA (maximum)	1 mA (maximum)
Input LOW level current	I _{IL}	-5.3 mA (maximum)	-2 mA (maximum)
Input impedance	R _{IN}	3 kΩ (minimum)	

EPSON	TITLE TM-U220 series Specification (STANDARD)	SHEET REVISION B	NO.	
			NEXT 21	SHEET 20

<AC characteristics>

Minimum reset pulse width: TRS 1 ms (minimum)

- When pin 6 (DSR) is used:

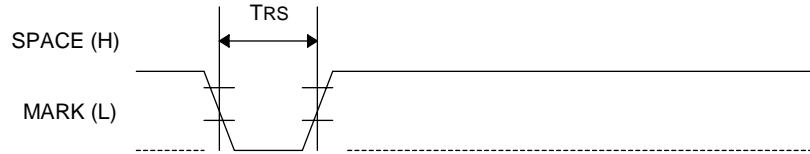

Figure 2.1.1 Reset Minimum Pulse Width (Pin 6)

- When pin 25 (INIT) is used:

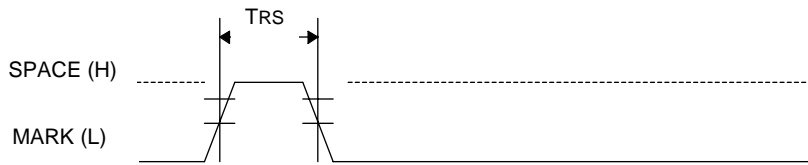

Figure 2.1.2 Reset Minimum Pulse Width (Pin 25)

- NOTES:
- Correct printer operation is not guaranteed unless the signals meet the above stated conditions. The above conditions must also be met when TTL signals are used to drive the DSR and INIT reset pins. Although a signal is input to pin 6 (DSR) at the TTL level, according to the DC characteristics described above, the operation is not guaranteed and pin 6 cannot be controlled.
 - When pin 6 (DSR) and pin 25 (INIT) are open, the printer is operating.

EPSON	TITLE	SHEET REVISION	NO.	
	TM-U220 series Specification (STANDARD)	B	NEXT 22	SHEET 21

2.1.2 IEEE 1284 Bidirectional Parallel Interface (Parallel Interface Specifications)

Copyright © 1994 by the Institute of Electrical and Electronic Engineers, Inc.

2.1.2.1 Compatibility mode
(data transmission from host to printer: Centronics-compatible)

1) Outline
Compatibility mode supports the compatibility with a Centronics parallel interface.

- 2) Specifications
- Data transmission: 8-bit parallel
 - Synchronization: Externally supplied nStrobe signals
 - Handshaking: nAck and Busy signals
 - Signal levels: TTL compatible
 - Connector: ADS-B36BLFDR176 (Honda) or equivalent (IEEE 1284 Type B)

2.1.2.2 Switching between online and offline

The printer is not equipped with any online/offline switch. The printer is placed into offline status in the following conditions:

- When the power is turned on or until the printer becomes ready for data transmission after it is initialized by the reset signal (nINIT) from the interface.
- During the self-test.
- When the cover is open.
- During paper feeding using the paper FEED button.
- When the printer stops printing due to a paper-end (in cases when empty paper supply is detected by either the roll paper end sensor or the roll paper near-end sensor with a printing halt due to a paper end enabled by **ESC c 4**).
- When an error has occurred.

2.1.2.3 Reverse mode (data transmission from printer to host)

The STATUS data transmission from the printer to the host proceeds in the Nibble or Byte mode.

- Description
This mode allows data transmission from the asynchronous printer under the control of the host. Data transmissions in the Nibble Mode are made via the existing control lines in units of four bits (a Nibble). In the Byte Mode, data transmissions are accomplished by making the eight-bit data lines bidirectional. Both modes cannot work at the same time with the Compatibility Mode, thereby causing half duplex transmission.

NOTE: A signal name preceded by the letter "n" indicates active LOW.

EPSON	TITLE TM-U220 series Specification (STANDARD)	SHEET REVISION B	NO.	
			NEXT 23	SHEET 22

Confidential

2.1.2.4 Interface pin assignments for each mode

Pin	Source	Compatibility Mode	Nibble Mode	Byte Mode
1	Host	nStrobe	HostClk	HostClk
2	Host/Ptr	Data0(LSB)	Data0(LSB)	Data0(LSB)
3	Host/Ptr	Data1	Data1	Data1
4	Host/Ptr	Data2	Data2	Data2
5	Host/Ptr	Data3	Data3	Data3
6	Host/Ptr	Data4	Data4	Data4
7	Host/Ptr	Data5	Data5	Data5
8	Host/Ptr	Data6	Data6	Data6
9	Host/Ptr	Data7(MSB)	Data7(MSB)	Data7(MSB)
10	Printer	nAck	PtrClk	PtrClk
11	Printer	Busy	PtrBusy/Data3, 7	PtrBusy
12	Printer	PError	AckDataReq/Data2, 6	AckDataReq
13	Printer	Select	Xflag/Data1, 5	Xflag
14	Host	nAutoFd	HostBusy	HostBusy
15		NC	ND	ND
16		GND	GND	GND
17		FG	FG	FG
18	Printer	Logic-H	Logic-H	Logic-H
19		GND	GND	GND
20		GND	GND	GND
21		GND	GND	GND
22		GND	GND	GND
23		GND	GND	GND
24		GND	GND	GND
25		GND	GND	GND
26		GND	GND	GND
27		GND	GND	GND
28		GND	GND	GND
29		GND	GND	GND
30		GND	GND	GND
31	Host	nInit	nInit	nInit
32	Printer	nFault	nDataAvail/Data0, 4	nDataAvail
33		GND	ND	ND
34	Printer	DK_STATUS	ND	ND
35	Printer	+5V	ND	ND
36	Host	nSelectIn	1284-Active	1284-Active

*NC: Not Connected

ND: Not Defined

EPSON	TITLE TM-U220 series Specification (STANDARD)	SHEET REVISION B	NO.	
			NEXT 24	SHEET 23

- NOTES:
1. A prefix "n" to signal names refers to "L" active signals. To the host not provided with all of the signal lines listed above, both-way communication fails.
 2. For interfacing, signal lines shall use twisted pair cables with the return sides connected to signal ground level.
 3. Interfacing conditions shall all be based on the TTL level to meet the characteristics described below. In addition, both rise time and fall time of each signal shall be 0.5 μ s or less.
 4. Data transmission shall not ignore the signal nAck or Busy. An attempt to transmit data with either signal, nAck or Busy, ignored can cause lost data.
 5. Interface cables shall be as short in length as possible.

2.1.2.5 Electrical characteristics

DC Characteristics (Except Logic-H, +5 V Signals)

Characteristics	Symbol	Specifications		Conditions
		Min	Max	
Output HIGH voltage	V_{OH}	*2.4 V	5.5 V	* $I_{OH}=0.32$ mA
Output LOW voltage	V_{OL}	-0.5 V	*0.4 V	* $I_{OL}=12$ mA
Output HIGH current	I_{OH}	0.32 mA	-	$V_{OH}=2.4$ V
Output LOW current	I_{OL}	-12 mA	-	$V_{OL}=0.4$ V
Input HIGH voltage	V_{IH}	2.0 V	-	$V_{IH}=2.0$ V $V_{IL}=0.8$ V
Input LOW voltage	V_{IL}	-	0.8 V	
Input HIGH current	I_{IH}	-	-0.32 mA	
Input LOW current	I_{IL}	-	12 mA	

Logic-H Signal Sender Characteristics

Characteristics	Symbol	Specifications		Conditions
		Min	Max	
Output HIGH voltage	V_{OH}	3.0 V	5.5 V	While the power is OFF
Output LOW voltage	V_{OL}	-	2.0 V	

+5 V Signal Sender Characteristics

Characteristics	Symbol	Specifications		Conditions
		Min	Max	
Output HIGH voltage	V_{OH}	*2.4 V	5.5 V	* $I_{OH}=0.32$ mA
Output LOW voltage	V_{OL}	-	- **	While the power is OFF
Output HIGH current	I_{OH}	-	0.32 mA	$V_{OH}=2.4$ V
Output LOW current	I_{OL}	- **	-	While the power is OFF

** No guarantee is offered to V_{OL} and I_{OL} while the power is OFF.

EPSON	TITLE	TM-U220 series Specification (STANDARD)	SHEET REVISION	NO.	
			B	NEXT 25	SHEET 24

2.1.2.6 Data receiving timing (compatibility mode)

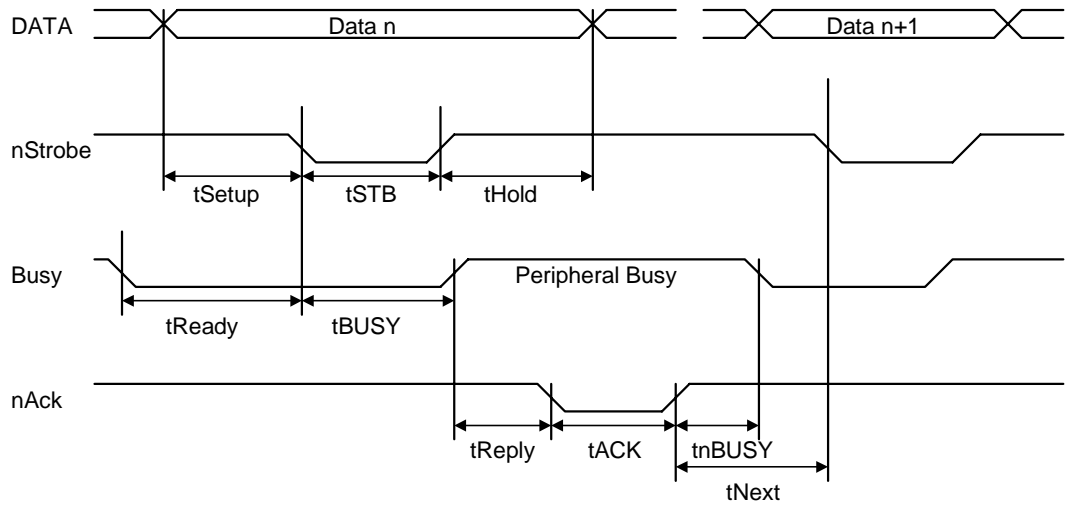

Characteristics	Symbol	Specifications	
		Min[ns]	Max[ns]
Data Hold Time (host)	tHold	750	--
Data Setup Time	tSetup	750	--
STROBE Pulse Width	tSTB	750	--
READY Cycle Idle Time	tReady	0	--
BUSY Output Delay Time	tBUSY	0	500
Data Processing Time	tReply	0	∞
ACKNLG Pulse Width	tACK	500	10 μs
BUSY Release Time	tnBUSY	0	∞
ACK Cycle Idle Time	tNext	0	--

*The printer latches data at a nStrobe ↓ timing

2.1.2.7 Notes on resetting the printer through the interface

The printer reset is available through the interface nInit signal (pin 31) by changing the DIP switch setting. (Refer to Table 3.3.4, DIP Switch 2 and Table 3.3.8, DIP Switch 2.)

Table 2.1.5 DIP Switch Setting for Printer Reset

Signal Line	DIP Switch	Reset Condition
Pin 31 (nInit)	2-8 On	TTL-LOW level input

The printer reset through the nInit signal is only available with the SelectIn (1284-Active) signal at LOW. To enable the printer reset, the following signal timing shall be satisfied.

Minimum reset pulse width: TRS 50 μ s (min.)
 Trailing edge period: tf 500 ns (max.)
 Leading edge period: tr 500 ns (max.)

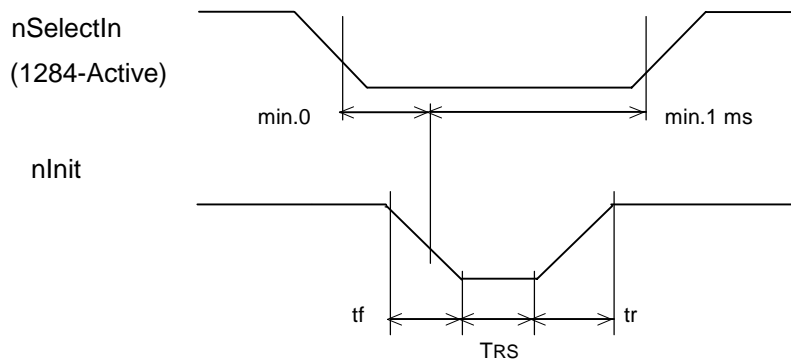

2.1.2.8 Notes on when DIP switch 1-8 is set to ON

- 1) The printer mechanism stops but does not become busy when: an error has occurred, printing stops due to a paper-end, or paper is fed using the paper FEED button.
- 2) When setting the memory switch to enable handshaking with the printer, be sure to check the printer status using the **GS a** command and the ASB function. In this setting, the default value of *n* for **GS a** is 2. The printer automatically transmits the printer status, depending on online/offline changes.
- 3) When using **DLE EOT**, **DLE ENQ**, and **DLE DC4** be sure that the receive buffer does not become full.

- When using a host that cannot transmit data when the printer is busy:
If an error has occurred, **DLE EOT**, **DLE ENQ**, and **DLE DC4** cannot be used when the printer is busy due to a receive buffer-full state.
- When using a host that can transmit data when the printer is busy:
When the receive buffer becomes full while transmitting bit-image data, and **DLE EOT**, **DLE ENQ**, or **DLE DC4** is used while sending bit-image data, the code is processed as bit-image data. The data transmitted when the receive buffer is full may be lost.

Example: Check the printer status using **GS r** after transmitting each line of data and use the 4KB receive buffer. Transmit data one line at a time so that the receive buffer does not become full.

EPSON	TITLE	SHEET REVISION	NO.	
	TM-U220 series Specification (STANDARD)	B	NEXT 27	SHEET 26

Confidential

2.1.2.9 Reception of status from the printer through the bidirectional parallel interface

In the bidirectional parallel interface specifications, the printer status transmission is available by using the bidirectional communication facility in the Nibble/Byte Modes in accordance with the IEEE 1284.

In this case, as opposed to the RS-232 serial interface specifications, the real-time interruptions from the printer to the host are disabled, and thus, precautions must be taken to the following.

- 1) Allowable capacity of the printer internal buffer is 99 bytes (except ASB status). Status signals exceeding this capacity will be discarded. To prevent possible loss of status, the host shall be ready for data acceptance (Reverse Mode).
- 2) When ASB is used, the host is preferably in the wait state for data acceptance (Reverse Idle Mode). When this state is not available, the host shall enter the Reverse Mode to constantly monitor the presence of data.
- 3) When ASB is used, preference shall be given to the ASB status for transmission over the other status signals. Any accumulated ASB status signals left for transmission from the last to the newest ASB status transmission shall be transmitted together at one time as one ASB status showing the presence of change, followed by the latest ASB status.

Example: In the normal (wait) state, the ASB status is configured as follows.

First Status	Second Status	Third Status	Fourth Status
0001 0000	0000 0000	0000 0000	0000 1111

When the following sequence of operations proceeds and near end is detected, and the FEED button is pressed and released, the following pieces of data are accumulated.

	First Status	Second Status	Third Status	Fourth Status	
①	0001 0000	0000 0000	0000 0011	0000 0000	Near end detection
②	0101 1000	0000 0000	0000 0011	0000 1111	FEED button is pressed
③	0001 0000	0000 0000	0000 0011	0000 0000	FEED button is released

When the ASB status is received following this, a total of eight (8) bytes of ASB will be transmitted as follows.

Accumulated ASB (①+②+③)

		First Status	Second Status	Third Status	Fourth Status
Accumulated ASB(①+②+③)		0101 1000	0000 0000	0000 0011	0000 0000
	+	First Status	Second Status	Third Status	Fourth Status
The latest ASB (③)		0001 0000	0000 0000	0000 0011	0000 0000
	Fourth Status				

<h1 style="margin: 0;">EPSON</h1>	TITLE	SHEET REVISION	NO.	
	TM-U220 series Specification (STANDARD)	B	NEXT 28	SHEET 27

2.2 Connectors

2.2.1 Interface connectors

Refer to Section 2.1, Interface Specifications.

1) RS-232 serial interface model

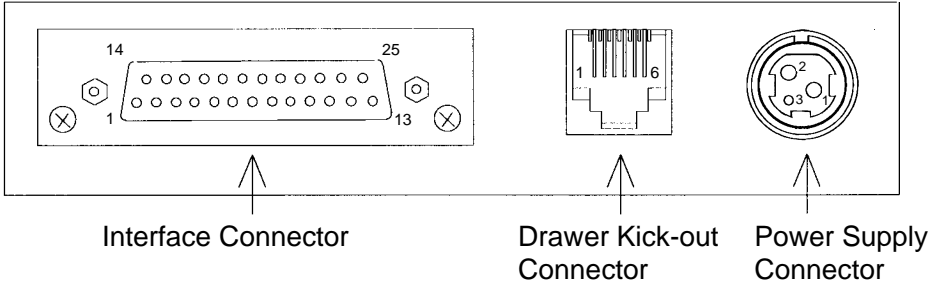

Figure 2.2.1 Serial Connector Panel Diagram

2) IEEE 1284 Parallel interface model

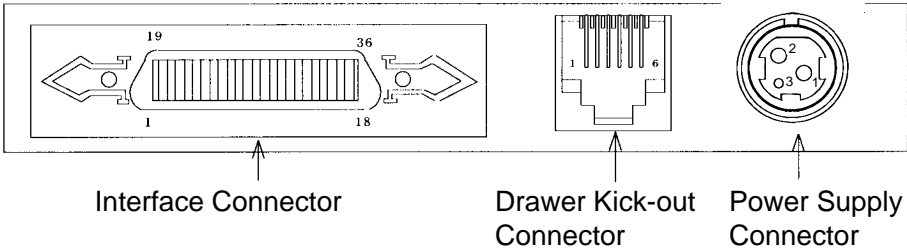

Figure 2.2.2 Parallel Connector Panel Diagram

NOTE: Be sure to ground the frame ground (FG) screw beside the interface connector.

EPSON	TITLE	SHEET REVISION	NO.	
	TM-U220 series Specification (STANDARD)	B	NEXT 29	SHEET 28

2.2.2 Power supply connector

This connector is used to connect the printer to an external power source.

- 1) Pin assignments: Refer to Table 2.2.1.
- 2) Model (printer side): Hosiden TCS7960-53-2010 (or equivalent)

Table 2.2.1 Power Supply Connector Pin Assignments

Pin Number	Signal Name
1	+ Power source
2	GND
3	NC
Shell	FG

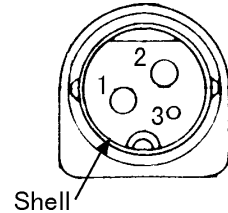
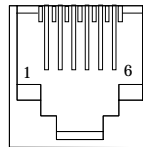

Figure 2.2.3 Power Supply Connector

2.2.3 Drawer kick-out connector (modular connector)

The signal specified by the **ESC p** command is output to this connector. The host can confirm the input signal state by using the **DLE EOT**, **GS a**, and **GS r** commands.

- 1) Pin assignments



+24 V is output through pin 4 when the power is turned on. However, pin 4 must be used only for the drawer.

Figure 2.2.4 Drawer Kick-out Connector

Table 2.2.2 Drawer Kick-out Connector Pin Assignments

Pin No.	Signal Name	Direction
1	Frame GND	--
2	Drawer kick-out drive signal 1	Output
3	Drawer open/close signal	Input
4	+24 V	--
5	Drawer kick-out drive signal 2	Output
6	Signal GND	--

- 2) Connector model: Printer side: DDK 285D-7660J-100 or equivalent
User side: 6-position 6-contact (RJ12 telephone jack)

EPSON	TITLE TM-U220 series Specification (STANDARD)	SHEET REVISION B	NO.	
			NEXT 30	SHEET 29

3) Drawer kick-out drive signal

Output signal: Voltage: Approximately 24 V
 Current: 1 A or less

CAUTION: To avoid an overcurrent, the resistance of the drawer kick-out solenoid must be 24Ω or more.

Output waveform: Outputs the waveforms in Figure 2.2.5 to points A and B in Figure 2.2.6.
 (The **ESC p** or **DLE DC4** command specifies ON time and OFF time.)

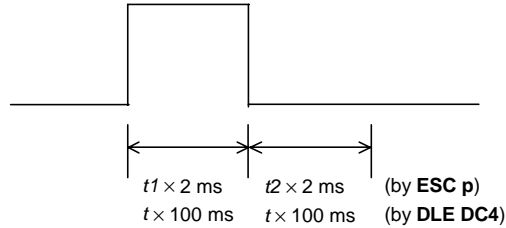

Figure 2.2.5 Drawer Kick-out Drive Signal

NOTE: ON time cannot be set less than 100 ms.

EPSON	TITLE	SHEET REVISION	NO.	
	TM-U220 series Specification (STANDARD)	B	NEXT 31	SHEET 30

4) Drawer open/close signal

Input signal level (connector pin 3):

“L” = 0 V , “H” = 2 to 5 V

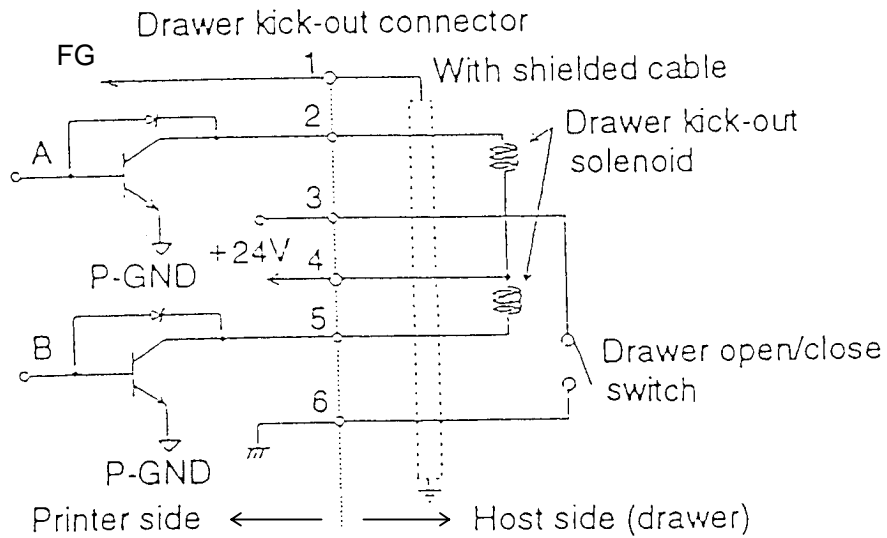

Figure 2.2.6 Drawer Circuitry

- NOTES:
- Use a shield cable for the drawer connector cable.
 - Two driver transistors cannot be driven simultaneously.
 - The drawer drive duty must be as shown below:

$$\frac{\text{On time}}{(\text{ON time} + \text{OFF time})} \leq 0.2$$

- Be sure to use the printer power supply (connector pin 4) for the drawer power source.
- The resistance of the drawer kick-out solenoid must not be less than the specified resistance. Otherwise, an overcurrent could damage the solenoid.

EPSON	TITLE	SHEET REVISION	NO.	
	TM-U220 series Specification (STANDARD)	B	NEXT 32	SHEET 31

3. FUNCTIONS

3.1 Commands

3.1.1 List of commands for all printer models

Command	Name
HT	Horizontal tab
LF	Print and line feed
CR	Print and carriage return
DLE EOT	Real-time status transmission
DLE ENQ	Real-time request to printer
DLE DC4	Generate pulse in real time
ESC SP	Set right-side character spacing
ESC !	Select print mode(s)
ESC %	Select/cancel user-defined character set
ESC &	Define user-defined characters
ESC *	Select bit-image mode
ESC -	Turn underline mode on/off
ESC 2	Select default line spacing
ESC 3	Set line spacing
ESC <	Return home
ESC =	Select peripheral device
ESC ?	Cancel user-defined character
ESC @	Initialize printer
ESC D	Set horizontal tab positions
ESC E	Turn emphasized mode on/off
ESC G	Turn double-strike mode on/off
ESC J	Feed paper and printing
ESC K	Print and reverse feed
ESC M	Select character font
ESC R	Select an international character set
ESC U	Turn unidirectional printing mode on/off
ESC a	Select justification
ESC c 3	Select paper sensor to output paper-end signal (only for parallel interface model)
ESC c 4	Select paper sensor(s) to stop printing
ESC c 5	Enable/disable panel buttons
ESC d	Printing and feed <i>n</i> lines
ESC e	Print and reverse feed <i>n</i> lines
ESC p	Generate pulse
ESC r	Select print color

EPSON	TITLE	SHEET REVISION	NO.	
	TM-U220 series Specification (STANDARD)	B	NEXT 33	SHEET 32

Command	Name
ESC t	Select character code table
ESC p	Generate pulse
ESC {	Turn upside-down printing mode on/off
FS p	Print NV bit image
FS q	Define NV bit image
GS (A	Execute test print
GS (C	Edit of user NV memory
GS (D	Enable/disable real-time command
GS (E	User setup commands
GS I	Transmit printer ID
GS V	Feed paper for cutting position
GS a	Enable/disable Automatic Status Back
GS r	Transmit status

3.1.2 List of commands for the Japanese, Simplified Chinese, Traditional Chinese, and Korean models

Command	Name
FS I	Set print mode(s) for Kanji characters
FS &	Select Kanji character mode
FS –	Turn underline mode on/off for Kanji characters
FS .	Cancel Kanji character mode
FS 2	Define user-defined Kanji characters
FS ?	Cancel user-defined Kanji characters
FS C	Select Kanji character code system
FS S	Set left-and right-side Kanji character spacing
FS W	Turn quadruple-size mode on/off for Kanji characters

3.1.3 Obsolete commands

The commands listed below in the first column are defined as “obsolete commands” in the ESC/POS® command system. This printer supports both upward-compatible commands and obsolete commands. However, the upward-compatible commands are recommended for use.

Obsolete command	Upward-compatible command
ESC i: Partial cut (one point left uncut)	GS V
ESC m: Partial cut (three point left uncut)	GS V
ESC u: Transmit peripheral device status	GS r
ESC v: Transmit paper sensor status	GS r

NOTE: “Obsolete commands” are commands that are supported by legacy models; however it is recommended to replace them with upward-compatible commands, because they will not be supported in the future products.

EPSON	TITLE TM-U220 series Specification (STANDARD)	SHEET REVISION B	NO.	
			NEXT 34	SHEET 33

3.2 Character Code Tables

3.2.1 Page 0 (PC437: U.S.A. Standard Europe) (International character set: U.S.A.)

HEX	0	1	2	3	4	5	6	7	8	9	A	B	C	D	E	F
HEX BIN	0000	0001	0010	0011	0100	0101	0110	0111	1000	1001	1010	1011	1100	1101	1110	1111
0	0000	NUL	DLE	SP	0	1	2	3	4	5	6	7	8	9	0	1
1	0001	XON	!	"	A	Q	a	q	ü	æ	í	í	í	í	í	í
2	0010		"	B	R	b	b	r	é	æ	ó	ó	ó	ó	ó	ó
3	0011	XOFF	#	C	S	c	c	s	á	ó	ú	ú	ú	ú	ú	ú
4	0100	EOT	DC4	D	T	d	d	t	ä	ö	ñ	ñ	ñ	ñ	ñ	ñ
5	0101	ENQ	%	E	U	e	e	u	à	ò	ñ	ñ	ñ	ñ	ñ	ñ
6	0110		&	F	V	f	f	v	á	ù	ä	ä	ä	ä	ä	ä
7	0111		,	G	W	g	g	w	ó	ù	ö	ö	ö	ö	ö	ö
8	1000	CAN	(H	X	h	h	x	é	ý	ú	ú	ú	ú	ú	ú
9	1001	HT)	I	Y	i	i	y	ë	ö	í	í	í	í	í	í
A	1010	LF	*	J	Z	j	j	z	è	ù	í	í	í	í	í	í
B	1011	ESC	+	K	[k	k	{	ì	ø	í	í	í	í	í	í
C	1100	FF	,	L	\	l	l		í	£	í	í	í	í	í	í
D	1101	CR	-	M]	m	m	}	î	¥	í	í	í	í	í	í
E	1110		.	N	^	n	n	~	ÿ	«	í	í	í	í	í	í
F	1111		/	O	_	o	o	¸	À	»	í	í	í	í	í	í

NOTE: The actual print patterns differ from those in the above character code.

<h1>EPSON</h1>	TITLE TM-U220 series Specification (STANDARD)	SHEET REVISION B	NO.	
			NEXT 35	SHEET 34

3.2.2 Page 1 (Katakana)

	HEX	8	9	A	B	C	D	E	F
HEX	BIN	1000	1001	1010	1011	1100	1101	1110	1111
0	0000	— 128	⊥ 144	SP 160	— 176	タ 192	ミ 208	ニ 224	× 240
1	0001	— 129	⊥ 145	。 161	ア 177	チ 193	ム 209	ト 225	円 241
2	0010	— 130	⊥ 146	「 162	イ 178	ツ 194	メ 210	キ 226	年 242
3	0011	— 131	⊥ 147	」 163	ウ 179	テ 195	モ 211	コ 227	月 243
4	0100	■ 132	— 148	、 164	エ 180	ト 196	ヤ 212	▲ 228	日 244
5	0101	■ 133	— 149	・ 165	オ 181	ナ 197	ユ 213	▲ 229	時 245
6	0110	■ 134	⊥ 150	ヲ 166	カ 182	ニ 198	ヨ 214	▼ 230	分 246
7	0111	■ 135	⊥ 151	ア 167	キ 183	ヌ 199	ラ 215	▼ 231	秒 247
8	1000	⊥ 136	⊥ 152	イ 168	ク 184	ネ 200	リ 216	♠ 232	〒 248
9	1001	⊥ 137	⊥ 153	ウ 169	ケ 185	ノ 201	ル 217	♥ 233	市 249
A	1010	⊥ 138	⊥ 154	エ 170	コ 186	ハ 202	レ 218	♦ 234	区 250
B	1011	⊥ 139	⊥ 155	オ 171	サ 187	ヒ 203	ロ 219	♣ 235	町 251
C	1100	⊥ 140	⊥ 156	ヤ 172	シ 188	フ 204	ワ 220	● 236	村 252
D	1101	⊥ 141	⊥ 157	ユ 173	ス 189	ヘ 205	ン 221	○ 237	人 253
E	1110	⊥ 142	⊥ 158	ヨ 174	セ 190	ホ 206	・ 222	/ 238	☼ 254
F	1111	⊥ 143	⊥ 159	ッ 175	ソ 191	マ 207	・ 223	＼ 239	SP 255

EPSON	TITLE	TM-U220 series Specification (STANDARD)	SHEET REVISION	NO.	
			B	NEXT 36	SHEET 35

3.2.3 Page 2 (PC850: Multilingual)

	HEX	8	9	A	B	C	D	E	F
HEX	BIN	1000	1001	1010	1011	1100	1101	1110	1111
0	0000	Ç 128	É 144	á 160	☼ 176	Ł 192	ø 208	Ó 224	— 240
1	0001	ü 129	æ 145	í 161	☼ 177	ł 193	Ð 209	ß 225	± 241
2	0010	é 130	Æ 146	ó 162	☼ 178	Ṭ 194	Ê 210	Ô 226	= 242
3	0011	â 131	ô 147	ú 163	 179	Ṭ 195	Ë 211	Ò 227	¼ 243
4	0100	ä 132	ö 148	ñ 164	† 180	— 196	Ë 212	õ 228	¶ 244
5	0101	à 133	ò 149	Ñ 165	À 181	† 197	ı 213	Ö 229	§ 245
6	0110	â 134	û 150	ä 166	Â 182	ã 198	í 214	µ 230	÷ 246
7	0111	ç 135	ù 151	ó 167	À 183	Ã 199	î 215	þ 231	• 247
8	1000	ê 136	ÿ 152	¿ 168	© 184	Ł 200	ï 216	þ 232	° 248
9	1001	ë 137	ö 153	® 169	¶ 185	Ŕ 201	ı 217	Ú 233	•• 249
A	1010	è 138	Û 154	¬ 170	 186	Ł 202	ŕ 218	Û 234	• 250
B	1011	ï 139	ø 155	½ 171	¶ 187	Ŧ 203	■ 219	Ü 235	ı 251
C	1100	î 140	£ 156	¼ 172	¶ 188	Ŧ 204	■ 220	Ý 236	³ 252
D	1101	ì 141	ø 157	ı 173	φ 189	— 205	ı 221	Ÿ 237	² 253
E	1110	Ä 142	× 158	« 174	¥ 190	† 206	Ï 222	— 238	■ 254
F	1111	Å 143	f 159	» 175	ƒ 191	Ŧ 207	■ 223	' 239	SP 255

EPSON	TITLE	TM-U220 series Specification (STANDARD)	SHEET REVISION	NO.	
			B	NEXT 37	SHEET 36

Confidential

3.2.4 Page 3 (PC860: Portuguese)

HEX	BIN	8	9	A	B	C	D	E	F
HEX	BIN	1000	1001	1010	1011	1100	1101	1110	1111
0	0000	Ç 128	É 144	Á 160	⌘ 176	Ł 192	⊥ 208	α 224	≡ 240
1	0001	ü 129	À 145	Í 161	⌘ 177	Ł 193	⊥ 209	β 225	± 241
2	0010	é 130	È 146	ó 162	⌘ 178	⊥ 194	⊥ 210	Γ 226	≥ 242
3	0011	â 131	ô 147	ú 163	⌘ 179	⊥ 195	⊥ 211	π 227	≤ 243
4	0100	ã 132	õ 148	ñ 164	⌘ 180	⊥ 196	⊥ 212	Σ 228	† 244
5	0101	à 133	ò 149	Ñ 165	⌘ 181	⊥ 197	⊥ 213	σ 229	‡ 245
6	0110	Á 134	Ú 150	á 166	⌘ 182	⊥ 198	⊥ 214	μ 230	÷ 246
7	0111	ç 135	ù 151	ó 167	⌘ 183	⊥ 199	⊥ 215	τ 231	≈ 247
8	1000	ê 136	î 152	ç 168	⌘ 184	⊥ 200	⊥ 216	Φ 232	° 248
9	1001	Ê 137	Ï 153	ò 169	⌘ 185	⊥ 201	⊥ 217	θ 233	• 249
A	1010	è 138	Û 154	¬ 170	⌘ 186	⊥ 202	⊥ 218	Ω 234	· 250
B	1011	í 139	ϕ 155	½ 171	⌘ 187	⊥ 203	⊥ 219	δ 235	√ 251
C	1100	ô 140	£ 156	¼ 172	⌘ 188	⊥ 204	⊥ 220	∞ 236	∞ 252
D	1101	ì 141	Ü 157	ï 173	⌘ 189	⊥ 205	⊥ 221	∅ 237	² 253
E	1110	Ā 142	ϖ 158	« 174	⌘ 190	⊥ 206	⊥ 222	ε 238	■ 254
F	1111	Â 143	Ó 159	» 175	⌘ 191	⊥ 207	⊥ 223	∩ 239	SP 255

EPSON	TITLE	SHEET REVISION	NO.	
	TM-U220 series Specification (STANDARD)	B	NEXT 38	SHEET 37

Confidential

3.2.5 Page 4 (PC863: Canadian-French)

HEX	HEX BIN	8	9	A	B	C	D	E	F
		1000	1001	1010	1011	1100	1101	1110	1111
0	0000	Ç 128	É 144	Ï 160	Ï 176	Ï 192	Ï 208	α 224	≡ 240
1	0001	ü 129	È 145	Ï 161	Ï 177	Ï 193	Ï 209	β 225	± 241
2	0010	é 130	È 146	ó 162	Ï 178	Ï 194	Ï 210	Γ 226	≥ 242
3	0011	â 131	ô 147	ú 163	Ï 179	Ï 195	Ï 211	π 227	≤ 243
4	0100	À 132	È 148	Ï 164	Ï 180	Ï 196	Ï 212	Σ 228	∫ 244
5	0101	à 133	Ï 149	Ï 165	Ï 181	Ï 197	Ï 213	σ 229	∫ 245
6	0110	∏ 134	û 150	Ï 166	Ï 182	Ï 198	Ï 214	μ 230	÷ 246
7	0111	ç 135	ù 151	Ï 167	Ï 183	Ï 199	Ï 215	τ 231	≈ 247
8	1000	ê 136	∏ 152	Ï 168	Ï 184	Ï 200	Ï 216	φ 232	° 248
9	1001	ë 137	ô 153	Ï 169	Ï 185	Ï 201	Ï 217	θ 233	• 249
A	1010	è 138	Ï 154	Ï 170	Ï 186	Ï 202	Ï 218	Ω 234	• 250
B	1011	ï 139	φ 155	½ 171	Ï 187	Ï 203	Ï 219	δ 235	√ 251
C	1100	î 140	£ 156	¼ 172	Ï 188	Ï 204	Ï 220	∞ 236	∞ 252
D	1101	— 141	Ï 157	¾ 173	Ï 189	Ï 205	Ï 221	∅ 237	ª 253
E	1110	À 142	Ï 158	« 174	Ï 190	Ï 206	Ï 222	€ 238	■ 254
F	1111	š 143	f 159	» 175	Ï 191	Ï 207	Ï 223	∩ 239	SP 255

EPSON	TITLE	TM-U220 series Specification (STANDARD)	SHEET REVISION	NO.	
			B	NEXT 39	SHEET 38

Confidential

3.2.6 Page 5 (PC865: Nordic)

HEX	8	9	A	B	C	D	E	F	
HEX BIN	1000	1001	1010	1011	1100	1101	1110	1111	
0	0000	Ç 128	É 144	á 160	⌘ 176	Ł 192	⌚ 208	α 224	≡ 240
1	0001	ü 129	æ 145	í 161	⌘ 177	Ł 193	⌚ 209	β 225	± 241
2	0010	é 130	Æ 146	ó 162	⌘ 178	Ł 194	⌚ 210	Γ 226	≥ 242
3	0011	â 131	ô 147	ú 163	⌘ 179	Ł 195	⌚ 211	π 227	≤ 243
4	0100	ä 132	ö 148	ñ 164	⌘ 180	Ł 196	⌚ 212	Σ 228	ƒ 244
5	0101	à 133	ò 149	Ñ 165	⌘ 181	Ł 197	⌚ 213	σ 229	Ƶ 245
6	0110	â 134	û 150	ä 166	⌘ 182	Ł 198	⌚ 214	μ 230	÷ 246
7	0111	ç 135	ù 151	ó 167	⌘ 183	Ł 199	⌚ 215	τ 231	≈ 247
8	1000	ê 136	ÿ 152	¿ 168	⌘ 184	Ł 200	⌚ 216	Φ 232	° 248
9	1001	ë 137	ÿ 153	ƒ 169	⌘ 185	Ł 201	⌚ 217	θ 233	• 249
A	1010	è 138	ÿ 154	ƒ 170	⌘ 186	Ł 202	⌚ 218	Ω 234	• 250
B	1011	ï 139	ø 155	½ 171	⌘ 187	Ł 203	⌚ 219	δ 235	√ 251
C	1100	î 140	£ 156	¼ 172	⌘ 188	Ł 204	⌚ 220	∞ 236	n 252
D	1101	ì 141	Ø 157	ı 173	⌘ 189	Ł 205	⌚ 221	ø 237	² 253
E	1110	Ä 142	ƒ 158	« 174	⌘ 190	Ł 206	⌚ 222	€ 238	■ 254
F	1111	Å 143	ƒ 159	⌘ 175	⌘ 191	Ł 207	⌚ 223	∩ 239	SP 255

EPSON	TITLE	SHEET REVISION	NO.	
	TM-U220 series Specification (STANDARD)	B	NEXT 40	SHEET 39

Confidential

3.2.7 Page 6 (Hiragana) (Available on the Japanese model)

	HEX	8	9	A	B	C	D	E	F
HEX	BIN	1000	1001	1010	1011	1100	1101	1110	1111
0	0000	礎 128	本 144	SP 160	ー 176	た 192	み 208	過 224	換 240
1	0001	129	145	。 161	あ 177	ち 193	む 209	225	241
2	0010	除 130	荷 146	「 162	い 178	つ 194	め 210	足 226	攻 242
3	0011	131	147	」 163	う 179	て 195	も 211	227	243
4	0100	定 132	特 148	、 164	え 180	と 196	や 212	利 228	産 244
5	0101	133	149	・ 165	お 181	な 197	ゆ 213	229	245
6	0110	信 134	越 150	を 166	か 182	に 198	よ 214	用 230	打 246
7	0111	135	151	あ 167	き 183	ぬ 199	ら 215	231	247
8	1000	緑 136	他 152	い 168	く 184	ね 200	り 216	移 232	納 248
9	1001	137	153	う 169	け 185	の 201	る 217	233	249
A	1010	科 138	社 154	え 170	こ 186	は 202	れ 218	下 234	変 250
B	1011	139	155	お 171	さ 187	ひ 203	ろ 219	235	251
C	1100	目 140	瓶 156	や 172	し 188	ふ 204	わ 220	加 236	誂 252
D	1101	141	157	ゆ 173	す 189	へ 205	ん 221	237	253
E	1110	々 142	奉 158	よ 174	せ 190	ほ 206	。 222	解 238	件 254
F	1111	143	159	っ 175	そ 191	ま 207	。 223	239	255

EPSON	TITLE	TM-U220 series Specification (STANDARD)	SHEET REVISION	NO.	
	B		NEXT	SHEET	
			41	40	

Confidential

3.2.8 Page 7 (One-pass printing Kanji characters) (Available on the Japanese model)

	HEX	8	9	A	B	C	D	E	F
HEX	BIN	1000	1001	1010	1011	1100	1101	1110	1111
0	0000	日 128	会 144	水 160	受 176	点 192	課 208	買 224	非 240
1	0001	129	145	161	177	193	209	225	241
2	0010	扱 130	客 146	木 162	前 178	中 194	証 210	号 226	承 242
3	0011	131	147	163	179	195	211	227	243
4	0100	外 132	券 148	土 164	残 180	内 196	組 212	有 228	送 244
5	0101	133	149	165	181	197	213	229	245
6	0110	額 134	回 150	振 166	止 182	部 198	店 214	期 230	一 246
7	0111	135	151	167	183	199	215	231	247
8	1000	割 136	在 152	数 168	純 184	別 200	認 216	限 232	棄 248
9	1001	137	153	169	185	201	217	233	249
A	1010	検 138	算 154	精 170	替 186	戻 202	廃 218	頭 234	累 250
B	1011	139	155	171	187	203	219	235	251
C	1100	高 140	上 156	銭 172	代 188	門 204	両 220	差 236	違 252
D	1101	141	157	173	189	205	221	237	253
E	1110	価 142	火 158	総 174	値 190	料 206	効 222	括 238	番 254
F	1111	143	159	175	191	207	223	239	255

EPSON	TITLE	SHEET REVISION	NO.	
	TM-U220 series Specification (STANDARD)	B	NEXT 42	SHEET 41

3.2.9 Page 8 (One-pass printing Kanji characters) (Available on the Japanese model)

	HEX	8	9	A	B	C	D	E	F
HEX	BIN	1000	1001	1010	1011	1100	1101	1110	1111
0	0000	訂 128	計 144	払 160	売 176	名 192	次 208	万 224	室 240
1	0001	129	145	161	177	193	209	225	241
2	0010	正 130	小 146	掛 162	取 178	個 194	不 210	責 226	商 242
3	0011	131	147	163	179	195	211	227	243
4	0100	品 132	金 148	入 164	係 180	領 196	枚 212	終 228	人 244
5	0101	133	149	165	181	197	213	229	245
6	0110	円 134	現 150	貸 166	未 182	収 198	誤 214	了 230	大 246
7	0111	135	151	167	183	199	215	231	247
8	1000	種 136	釣 152	出 168	消 184	予 200	休 216	免 232	安 248
9	1001	137	153	169	185	201	217	233	249
A	1010	担 138	預 154	支 170	費 186	約 202	契 218	伝 234	仕 250
B	1011	139	155	171	187	203	219	235	251
C	1100	当 140	税 156	単 172	年 188	込 204	開 220	自 236	控 252
D	1101	141	157	173	189	205	221	237	253
E	1110	合 142	引 158	返 174	月 190	明 206	閉 222	設 238	基 254
F	1111	143	159	175	191	207	223	239	255

EPSON	TITLE	SHEET REVISION	NO.	
	TM-U220 series Specification (STANDARD)	B	NEXT 43	SHEET 42

Confidential

3.2.10 Page 16 (WPC1252)

	HEX	8	9	A	B	C	D	E	F
HEX	BIN	1000	1001	1010	1011	1100	1101	1110	1111
0	0000	€ 128	SP 144	SP 160	° 176	À 192	Ð 208	à 224	ð 240
1	0001	SP 129	' 145	ı 161	± 177	Á 193	Ñ 209	á 225	ñ 241
2	0010	' 130	' 146	¢ 162	ˆ 178	Â 194	Ò 210	â 226	ò 242
3	0011	f 131	" 147	£ 163	ˆ 179	Ã 195	Ó 211	ã 227	ó 243
4	0100	" 132	" 148	¤ 164	ˆ 180	Ä 196	Ô 212	ä 228	ô 244
5	0101	… 133	• 149	¥ 165	µ 181	Å 197	Õ 213	å 229	õ 245
6	0110	† 134	- 150	ı 166	¶ 182	Æ 198	Ö 214	æ 230	ö 246
7	0111	‡ 135	- 151	§ 167	· 183	Ç 199	× 215	ç 231	+ 247
8	1000	^ 136	˘ 152	¨ 168	˙ 184	È 200	Ø 216	è 232	ø 248
9	1001	‰ 137	™ 153	© 169	ı ¹ 185	É 201	Ù 217	é 233	ù 249
A	1010	Š 138	š 154	ª ^a 170	º ^o 186	Ê 202	Ú 218	ê 234	ú 250
B	1011	‹ 139	› 155	« 171	» 187	Ë 203	Û 219	ë 235	û 251
C	1100	Œ 140	œ 156	¬ 172	¼ ¹ 188	Ì 204	Ü 220	ì 236	ü 252
D	1101	SP 141	SP 157	· 173	½ ¹ 189	Í 205	Ý 221	í 237	ý 253
E	1110	Ž 142	ž 158	® 174	¾ ¹ 190	Î 206	Þ 222	î 238	þ 254
F	1111	SP 143	ÿ 159	- 175	¿ ¹ 191	Ï 207	ß 223	ï 239	ÿ 255

EPSON	TITLE	TM-U220 series Specification (STANDARD)	SHEET REVISION	NO.	
			B	NEXT 44	SHEET 43

3.2.11 Page 17 (PC866: Cyrillic #2)

	HEX	8	9	A	B	C	D	E	F
HEX	BIN	1000	1001	1010	1011	1100	1101	1110	1111
0	0000	А 128	Р 144	а 160	▣ 176	▣ 192	▣ 208	р 224	ё 240
1	0001	Б 129	С 145	б 161	▣ 177	▣ 193	▣ 209	с 225	ё 241
2	0010	В 130	Т 146	в 162	▣ 178	▣ 194	▣ 210	т 226	ё 242
3	0011	Г 131	У 147	г 163	▣ 179	▣ 195	▣ 211	у 227	ё 243
4	0100	Д 132	Ф 148	д 164	▣ 180	▣ 196	▣ 212	ф 228	й 244
5	0101	Е 133	Х 149	е 165	▣ 181	▣ 197	▣ 213	х 229	й 245
6	0110	Ж 134	Ц 150	ж 166	▣ 182	▣ 198	▣ 214	ц 230	й 246
7	0111	З 135	Ч 151	з 167	▣ 183	▣ 199	▣ 215	ч 231	й 247
8	1000	И 136	Ш 152	и 168	▣ 184	▣ 200	▣ 216	ш 232	° 248
9	1001	Й 137	Щ 153	й 169	▣ 185	▣ 201	▣ 217	щ 233	° 249
A	1010	К 138	Ъ 154	к 170	▣ 186	▣ 202	▣ 218	ъ 234	° 250
B	1011	Л 139	Ы 155	л 171	▣ 187	▣ 203	▣ 219	ы 235	✓ 251
C	1100	М 140	Ь 156	м 172	▣ 188	▣ 204	▣ 220	ь 236	№ 252
D	1101	Н 141	Э 157	н 173	▣ 189	▣ 205	▣ 221	э 237	□ 253
E	1110	О 142	Ю 158	о 174	▣ 190	▣ 206	▣ 222	ю 238	■ 254
F	1111	П 143	Я 159	п 175	▣ 191	▣ 207	▣ 223	я 239	SP 255

EPSON	TITLE	SHEET REVISION	NO.	
	TM-U220 series Specification (STANDARD)	B	NEXT 45	SHEET 44

Confidential

3.2.12 Page 18 (PC852: Latin2)

	HEX	8	9	A	B	C	D	E	F
HEX	BIN	1000	1001	1010	1011	1100	1101	1110	1111
0	0000	Ç 128	É 144	á 160	▣ 176	Ł 192	đ 208	Ó 224	- 240
1	0001	ü 129	Ĺ 145	í 161	▣ 177	Ł 193	Đ 209	ß 225	" 241
2	0010	é 130	í 146	ó 162	▣ 178	Ł 194	Ď 210	Ô 226	˘ 242
3	0011	â 131	ô 147	ú 163	Ł 179	Ł 195	Ě 211	Ń 227	˘ 243
4	0100	ä 132	ö 148	À 164	Ł 180	Ł 196	ď 212	ń 228	˘ 244
5	0101	ù 133	Ĺ 149	ą 165	Á 181	Ł 197	Ň 213	ň 229	§ 245
6	0110	ć 134	ĩ 150	ż 166	Â 182	Å 198	í 214	š 230	÷ 246
7	0111	ç 135	ś 151	ź 167	Ě 183	ä 199	î 215	š 231	˘ 247
8	1000	ł 136	ś 152	Ę 168	Ş 184	Ł 200	ě 216	Ŕ 232	˘ 248
9	1001	ē 137	Ö 153	ę 169	Ł 185	Ł 201	Ĵ 217	Ú 233	˘ 249
A	1010	Ő 138	Ü 154	SP 170	Ł 186	Ł 202	Ł 218	ı 234	˘ 250
B	1011	ő 139	Ŧ 155	ź 171	Ł 187	Ł 203	▣ 219	Ū 235	ü 251
C	1100	î 140	ĩ 156	Č 172	Ł 188	Ł 204	▣ 220	ý 236	Ř 252
D	1101	ž 141	Ł 157	š 173	Ž 189	Ł 205	Ł 221	Ý 237	ř 253
E	1110	Ä 142	× 158	« 174	ž 190	Ł 206	Ū 222	ł 238	▣ 254
F	1111	Ć 143	č 159	» 175	Ł 191	Ł 207	▣ 223	˘ 239	SP 255

EPSON	TITLE	SHEET REVISION	NO.	
	TM-U220 series Specification (STANDARD)	B	NEXT 46	SHEET 45

Confidential

3.2.13 Page 19 (PC858:Euro)

	HEX	8	9	A	B	C	D	E	F
HEX	BIN	1000	1001	1010	1011	1100	1101	1110	1111
0	0000	Ç 128	É 144	á 160	⌘ 176	Ł 192	ð 208	Ó 224	— 240
1	0001	ü 129	æ 145	í 161	⌘ 177	± 193	Ð 209	ß 225	± 241
2	0010	é 130	Æ 146	ó 162	⌘ 178	τ 194	Ê 210	Ô 226	= 242
3	0011	â 131	ô 147	ú 163	 179	† 195	Ë 211	Ö 227	¼ 243
4	0100	ä 132	ö 148	ñ 164	‡ 180	— 196	È 212	õ 228	¶ 244
5	0101	à 133	ò 149	Ñ 165	À 181	+ 197	€ 213	ö 229	§ 245
6	0110	â 134	û 150	ä 166	Â 182	ã 198	í 214	µ 230	÷ 246
7	0111	ç 135	ù 151	ó 167	À 183	Ã 199	î 215	þ 231	· 247
8	1000	ê 136	ÿ 152	¿ 168	© 184	Ł 200	ï 216	ÿ 232	° 248
9	1001	ë 137	Ö 153	® 169	‡ 185	ƒ 201	ƒ 217	Ú 233	· 249
A	1010	è 138	Û 154	¬ 170	 186	± 202	ƒ 218	Û 234	· 250
B	1011	ï 139	ø 155	½ 171	¶ 187	τ 203	■ 219	Û 235	¹ 251
C	1100	î 140	£ 156	¼ 172	¶ 188	ƒ 204	■ 220	ý 236	³ 252
D	1101	ì 141	Ø 157	í 173	Φ 189	= 205	í 221	ÿ 237	² 253
E	1110	Ä 142	× 158	« 174	¥ 190	† 206	î 222	— 238	■ 254
F	1111	Å 143	f 159	» 175	γ 191	α 207	■ 223	' 239	SP 255

EPSON	TITLE	TM-U220 series Specification (STANDARD)	SHEET REVISION	NO.	
			B	NEXT 47	SHEET 46

3.2.14 Page 20 (Thai Character Code 42) (Available on the Thai model)

	8	9	A	B	C	D	E	F
0	ร	๐		ฌ	ย	ไ	.	D3
1	๗	๑	ก	ฌ	จ	แ	๘	D+
2	๕	๒	บ	ด	ถ	โ	๙	D๑
3	๔	๓	ค	ต	ฉ	ใ	+	D-
4		๔	ฆ	ถ	ว	ไ	๑	D๕
5	-	๕	ง	ท	ศ	๗	.	D3
6	๒	๖	จ	ช	๕	๗	๐	D+
7	๒	๓	ฉ	น	ส	๐	๐๕	D-
8	๒	๘	ช	บ	ห	๘	๐๖	D๕
9	T	๙	ช	บ	ฬ	๒	๐+	D3
A	+	๒	ฌ	ผ	อ	๒	๑-	D+
B	■	ค	ฉ	ผ	ฮ	๒	๑๕	D-
C	←	๙	ฉ	ฬ	๕	๒	๑๖	D๕
D	↑	๑	ฉ	ฬ	ถ	๕	๑+	D3
E	→	๙	ฉ	ถ	๗	๐	D-	D+
F	↓	ไ	ท	ม	๗	๘	D๕	

3.2.15 Page 21 (Thai Character Code 11) (Available on the Thai model)

	8	9	A	B	C	D	E	F
0	๘	๙	ไ	ฐ	ภ	๕	เ	๐
1	๘๕	๙	ก	ท	ม	๖	แ	๑
2	๘๖	๙๖	บ	ษ	ย	๗	โ	๒
3	๘๗	๙๗	ป	ณ	ร	๘	ใ	๓
4	๘๘	๙๘	ค	ด	ถ	๙	ไ	๔
5	๘๙	๙๙	ค	ด	ล	๐	๗	๕
6	๘๐	๙๐	ฆ	ถ	ภ	๑	๗	๖
7	๘๑	๙๑	ง	ท	ว	๒	๘	๗
8	๘๒	๙๒	จ	ธ	ศ	๓	.	๘
9	๘๓	๙๓	ฉ	น	ษ	๔	๘	๙
A	๘๔	๙๔	ช	บ	ส	๕	๙	๐
B	๘๕	๙๕	ซ	ป	ห	-	+	๑
C	๘๖	๙๖	ฌ	ฬ	ฬ	๑	๘	๒
D	๘๗	๙๗	ฎ	ฬ	อ	๒	๐	๓
E	๘๘	๙๘	ฏ	ฬ	ฮ	๓	๘	๔
F	๘๙	๙๙	ฏ	ฬ	๗	๔	๐	

EPSON	TITLE	SHEET REVISION	NO.	
	TM-U220 series Specification (STANDARD)	B	NEXT 49	SHEET 48

3.2.16 Page 22 (Thai Character Code 13) (Available on the Thai model)

	8	9	A	B	C	D	E	F
0		๒-		๒๓	๒๔	๒๕	๒๖	๒๗
1	๒๘	๒๙	๒๐	๒๑	๒๒	๒๓	๒๔	๒๕
2	๒๖	๒๗	๒๘	๒๙	๒๐	๒๑	๒๒	๒๓
3	๒๔	๒๕	๒๖	๒๗	๒๘	๒๙	๒๐	๒๑
4	๒๒		๒๓	๒๔	๒๕	๒๖	๒๗	๒๘
5		๒-	๒๐	๒๑	๒๒	๒๓	๒๔	๒๕
6	๒๖	๒๗	๒๘	๒๙	๒๐	๒๑	๒๒	๒๓
7	๒๔	๒๕	๒๖	๒๗	๒๘	๒๙	๒๐	๒๑
8	๒๒	๒๓	๒๔	๒๕	๒๖	๒๗	๒๘	๒๙
9	๒๐		๒๑	๒๒	๒๓	๒๔	๒๕	๒๖
A		๒-	๒๐	๒๑	๒๒	๒๓	๒๔	๒๕
B	๒๖	๒๗	๒๘	๒๙	๒๐	๒๑	๒๒	๒๓
C	๒๔	๒๕	๒๖	๒๗	๒๘	๒๙	๒๐	๒๑
D	๒๒	๒๓	๒๔	๒๕	๒๖	๒๗	๒๘	๒๙
E	๒๐		๒๑	๒๒	๒๓	๒๔	๒๕	๒๖
F	๒๖		๒๗	๒๘	๒๙	๒๐	๒๑	๒๒

3.2.17 Page 23 (Thai Character Code 14) (Available on the Thai model)

	8	9	A	B	C	D	E	F
0	ร	ร		ฐ	ฎ	๕	เ	๐
1	๖	๑	ก	ท	ม	๕	แ	๑
2	๗	๕	บ	ษ	ย	๖	โ	๒
3	๘	๕๕	ป	ฉ	ร	๖	ใ	๓
4	๙	๕๖	ค	ด	ถ	๖	ไ	๔
5	-	๕๗	ค	ด	ฉ	๖	๖	๕
6	๑	๖	ฆ	ถ	ฎ	๖	๖	๖
7	๒	๖๕	ง	ท	ว	๖	๖	๗
8	๓	๖๖	จ	ฉ	ศ	๖	,	๘
9	๔	๖๗	ฉ	น	ช	๖	๖	๙
A	๕	๖๘	ช	บ	ส	๖	๖	๐
B	■	๖๙	ช	บ	ท	๖	+	๖
C	๐	๗๐	ฉ	ฝ	ฬ	๖	๖	๗
D	๑	๗๑	ฉ	ฝ	อ	๖	๐	๗๑
E	๒	๗๒	ฎ	ฬ	ฮ	๗	๖	๗๒
F	๓	๗๓	ฎ	ฬ	๖	๗	๐	๗๓

3.2.18 Page 24 (Thai Character Code 16) (Available on the Thai model)

	8	9	A	B	C	D	E	F
0	ร	โ		ฐ	ภ	๕	เ	๐
1	๖	ใ	ก	ท	ม	๖	แ	๑
2	๗	๕	บ	ฌ	ย	๗	๙	๒
3	๘	๕๕	ป	ฌ	ร	๗	๑	๓
4		๕๖	ค	ด	ถ	๘	๙	๔
5	-	๕๗	ค	ด	ล	๘	๗	๕
6	๓	๘	ฆ	ถ	ภ	๘	๗	๖
7	๓	๘๕	ง	ท	ว	๘	๙	๗
8	๓	๘๖	จ	อ	ศ	๐	.	๘
9	๓	๘๗	ฉ	น	ช	๑	๕	๙
A	๓	๘๘	ช	บ	ส	.	๖	๙
B	■	๘๙	ช	บ	ท	๘	+	๘
C	←	๙๐	ฉ	ฉ	ฬ	๘๕	๑	๘๕
D	↑	๙๑	ฉ	ฉ	อ	๘๖	๐	๘๖
E	→	๙๒	ฉ	ฬ	ฮ	๘๗	๗	๘๗
F	↓	๙๓	ฉ	ฬ	๗	๘๘	๐	

3.2.19 Page 25 (Thai Character Code 17) (Available on the Thai model)

	8	9	A	B	C	D	E	F
0	๘	๙		๘	๙	๘	๙	๐
1	๘๘	๙๘	๙	๙	๘	๘	๙	๑
2	๘๘	๙๘	๘	๙	๘	๙	๘	๒
3	๘๘	๙๘	๘	๙	๘	๙	๘	๓
4	๘๘	๙๘	๘	๙	๘	๙	๘	๔
5	๘๘	๙๘	๘	๙	๘	๙	๘	๕
6	๘๘	๙๘	๘	๙	๘	๙	๘	๖
7	๘๘	๙๘	๘	๙	๘	๙	๘	๗
8	๘๘	๙๘	๘	๙	๘	๙	๘	๘
9	๘๘	๙๘	๘	๙	๘	๙	๘	๙
A	๘๘	๙๘	๘	๙	๘	๙	๘	๐
B	๘๘	๙๘	๘	๙	๘	๙	๘	๑
C	๘๘	๙๘	๘	๙	๘	๙	๘	๒
D	๘๘	๙๘	๘	๙	๘	๙	๘	๓
E	๘๘	๙๘	๘	๙	๘	๙	๘	๔
F	๘๘	๙๘	๘	๙	๘	๙	๘	๕

EPSON	TITLE	SHEET REVISION	NO.	
	TM-U220 series Specification (STANDARD)	B	NEXT 53	SHEET 52

3.2.20 Page 26 (Thai Character Code 18) (Available on the Thai model)

	8	9	A	B	C	D	E	F
0	ร	ร		ฐ	ภ	ะ	เ	อ
1	ร	ร	ก	ท	ม	ุ	แ	อ
2	ร	ร	บ	ผ	ย	า	โ	๒
3	ร	ร	ป	ผ	ร	า	ใ	๓
4		ร	ค	ค	ถ	ุ	ไ	๔
5	-	ร	ค	ค	ถ	ุ	า	๕
6	+	ร	ฆ	ถ	ภ	ุ	า	๖
7	+	ร	ง	ท	ว	ุ	๔	๗
8	+	ร	จ	ธ	ศ	ุ	.	๘
9	T	ร	ฉ	น	ษ	ุ	ุ	๙
A	+	ร	ช	บ	ส	.	ุ	๑๐
B	■	ร	ช	บ	ห	ุ	+	๑๑
C	←	ร	ฉ	ผ	ฬ	ุ	ุ	๑๒
D	↑	ร	อ	ผ	อ	ุ	ุ	๑๓
E	→	ร	อ	ผ	ฮ	ุ	ุ	๑๔
F	↓	ร	อ	ผ	า	฿	๐	

3.2.21 Page 254 (space page)

	HEX	8	9	A	B	C	D	E	F
	HEX	1000	1001	1010	1011	1100	1101	1110	1111
0	0000	SP 128	SP 144	SP 160	SP 176	SP 192	SP 208	SP 224	SP 240
1	0001	SP 129	SP 145	SP 161	SP 177	SP 193	SP 209	SP 225	SP 241
2	0010	SP 130	SP 146	SP 162	SP 178	SP 194	SP 210	SP 226	SP 242
3	0011	SP 131	SP 147	SP 163	SP 179	SP 195	SP 211	SP 227	SP 243
4	0100	SP 132	SP 148	SP 164	SP 180	SP 196	SP 212	SP 228	SP 244
5	0101	SP 133	SP 149	SP 165	SP 181	SP 197	SP 213	SP 229	SP 245
6	0110	SP 134	SP 150	SP 166	SP 182	SP 198	SP 214	SP 230	SP 246
7	0111	SP 135	SP 151	SP 167	SP 183	SP 199	SP 215	SP 231	SP 247
8	1000	SP 136	SP 152	SP 168	SP 184	SP 200	SP 216	SP 232	SP 248
9	1001	SP 137	SP 153	SP 169	SP 185	SP 201	SP 217	SP 233	SP 249
A	1010	SP 138	SP 154	SP 170	SP 186	SP 202	SP 218	SP 234	SP 250
B	1011	SP 139	SP 155	SP 171	SP 187	SP 203	SP 219	SP 235	SP 251
C	1100	SP 140	SP 156	SP 172	SP 188	SP 204	SP 220	SP 236	SP 252
D	1101	SP 141	SP 157	SP 173	SP 189	SP 205	SP 221	SP 237	SP 253
E	1110	SP 142	SP 158	SP 174	SP 190	SP 206	SP 222	SP 238	SP 254
F	1111	SP 143	SP 159	SP 175	SP 191	SP 207	SP 223	SP 239	SP 255

EPSON	TITLE	SHEET REVISION	NO.	
	TM-U220 series Specification (STANDARD)	B	NEXT 55	SHEET 54

3.2.22 Page 255 (space page)

	HEX	8	9	A	B	C	D	E	F
HEX	BIN	1000	1001	1010	1011	1100	1101	1110	1111
0	0000	SP 128	SP 144	SP 160	SP 176	SP 192	SP 208	SP 224	SP 240
1	0001	SP 129	SP 145	SP 161	SP 177	SP 193	SP 209	SP 225	SP 241
2	0010	SP 130	SP 146	SP 162	SP 178	SP 194	SP 210	SP 226	SP 242
3	0011	SP 131	SP 147	SP 163	SP 179	SP 195	SP 211	SP 227	SP 243
4	0100	SP 132	SP 148	SP 164	SP 180	SP 196	SP 212	SP 228	SP 244
5	0101	SP 133	SP 149	SP 165	SP 181	SP 197	SP 213	SP 229	SP 245
6	0110	SP 134	SP 150	SP 166	SP 182	SP 198	SP 214	SP 230	SP 246
7	0111	SP 135	SP 151	SP 167	SP 183	SP 199	SP 215	SP 231	SP 247
8	1000	SP 136	SP 152	SP 168	SP 184	SP 200	SP 216	SP 232	SP 248
9	1001	SP 137	SP 153	SP 169	SP 185	SP 201	SP 217	SP 233	SP 249
A	1010	SP 138	SP 154	SP 170	SP 186	SP 202	SP 218	SP 234	SP 250
B	1011	SP 139	SP 155	SP 171	SP 187	SP 203	SP 219	SP 235	SP 251
C	1100	SP 140	SP 156	SP 172	SP 188	SP 204	SP 220	SP 236	SP 252
D	1101	SP 141	SP 157	SP 173	SP 189	SP 205	SP 221	SP 237	SP 253
E	1110	SP 142	SP 158	SP 174	SP 190	SP 206	SP 222	SP 238	SP 254
F	1111	SP 143	SP 159	SP 175	SP 191	SP 207	SP 223	SP 239	SP 255

EPSON	TITLE	SHEET REVISION	NO.	
	TM-U220 series Specification (STANDARD)	B	NEXT 56	SHEET 55

3.2.23 International character sets

Country	ASCII code (HEX)											
	23	24	40	5B	5C	5D	5E	60	7B	7C	7D	7E
0 U.S.A.	#	\$	@	[\]	^	`	{		}	~
1 France	#	\$	à	°	ç	§	^	`	é	ù	è	¨
2 Germany	#	\$	§	Ä	Ö	Ü	^	`	ä	ö	ü	ß
3 U.K.	£	\$	@	[\]	^	`	{		}	~
4 Denmark I	#	\$	@	Æ	Ø	Å	^	`	æ	ø	å	~
5 Sweden	#	□	É	Ä	Ö	Å	Ü	é	ä	ö	å	ü
6 Italy	#	\$	@	°	\	é	^	ù	à	ò	è	ì
7 Spain I	Pt	\$	@	ı	Ñ	ı	^	`	¨	ñ	}	~
8 Japan	#	\$	@	[¥]	^	`	{		}	~
9 Norway	#	□	É	Æ	Ø	Å	Ü	é	æ	ø	å	ü
10 Denmark II	#	\$	É	Æ	Ø	Å	Ü	é	æ	ø	å	ü
11 Spain II	#	\$	á	ı	Ñ	ı	é	`	ı	ñ	ó	ú
12 Latin America	#	\$	á	ı	Ñ	ı	é	ü	ı	ñ	ó	ú
13 Korea	#	\$	@	[₩]	^	`	{		}	~
14 Slovenia/Croatia	#	\$	Ž	Š	Đ	Ć	Č	ž	š	đ	ć	č
15 China	#	¥	@	[\]	^	`	{		}	~

EPSON	TITLE	SHEET REVISION	NO.	
	TM-U220 series Specification (STANDARD)	B	NEXT 57	SHEET 56

3.3 Switches and Buttons

3.3.1 Power button

The power button (rocker switch) is located on the upper right front of the printer turns the power on or off.

3.3.2 Panel buttons

FEED button (Non-locking push button)

- [Function]
- If you push this button once and release it, the printer feeds paper one line, based on the line spacing set by **ESC 2** and **ESC 3**. However, paper feeding using the FEED button cannot be performed when the roll paper end sensor detects a paper end.
 - During self-test printing, you can stop the self-test temporarily by pressing this button and restart it by pressing the button again.

NOTE: This button is disabled by **ESC c 5**.

EPSON	TITLE TM-U220 series Specification (STANDARD)	SHEET REVISION B	NO.	
			NEXT 58	SHEET 57

3.3.3 DIP switches

Look at the numbers and letters in the area indicated in the illustration. If the last letters are "US", use the "US" table in Section 3.3.3.1. If the last letters are "STD", use the "STD" tables in Section 3.3.3.2.

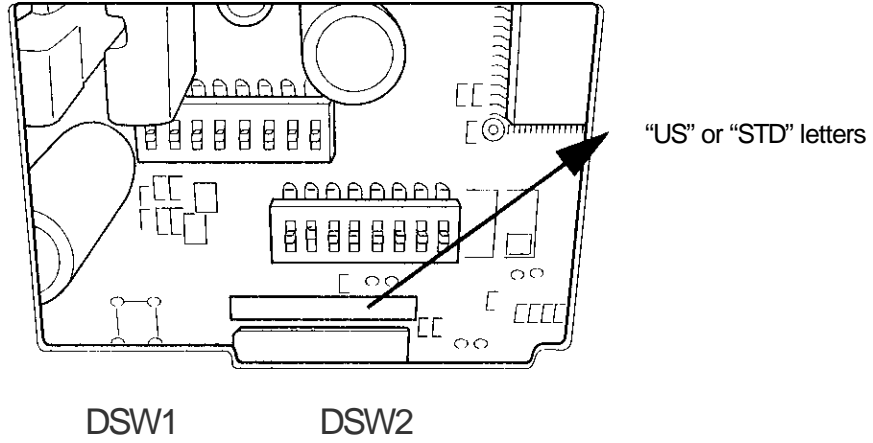

EPSON	TITLE	TM-U220 series Specification (STANDARD)	SHEET REVISION	NO.	
			B	NEXT 59	SHEET 58

3.3.3.1 US model

1) Serial interface model

Table 3.3.1 DIP Switch 1

Switch No.	Function	ON	OFF	Default	
				B	D
1	Data reception error	Ignored	Print “?”	Off	Off
2	Receive buffer capacity	40 bytes	4KB	Off	Off
3	Handshaking	XON/XOFF	DTR/DSR	Off	Off
4	Word length	7 bits	8 bits	Off	Off
5	Parity check	Yes	No	Off	Off
6	Parity selection	Even	Odd	Off	Off
7	Transmission speed selection	4800 bps	9600 bps	Off	Off
8	BUSY condition	•Receive buffer-full	•Offline •Receive buffer-full	Off	Off

Table 3.3.2 DIP Switch 2

Switch No.	Function	ON	OFF	Default	
				B	D
1	Selects number of characters per line (cpl) (*)	42 cpl / 35 cpl	40 cpl / 33 cpl	Off	Off
2	Reserved (Autocutter)	Enabled	Disabled	On	Off
3	Pin 6 reset signal	Used	Not used	Off	Off
4	Pin 25 reset signal	Used	Not used	Off	Off
5	Undefined	--	--	Off	Off
6	Reserved (Flash memory rewriting)	Enabled	Disabled	Off	Off
7	Undefined	--	--	Off	Off
8	Serial communication set selection	By memory switch	By DIP switch	Off	Off

(*) Selection of dots between characters: On = 2 half dots, Off = 3 half dots
 The number of characters per line in the Table indicates for the 76 mm-width paper.

EPSON	TITLE TM-U220 series Specification (STANDARD)	SHEET REVISION B	NO.	
			NEXT 60	SHEET 59

2) Parallel interface model

Table 3.3.3 DIP Switch 1

Switch No.	Function	ON	OFF	Default	
				B	D
1	Auto line feed	Enabled	Disabled	Off	Off
2	Receive buffer	40 bytes	4KB	Off	Off
3	Undefined	--	--	Off	Off
4	Undefined	--	--	Off	Off
5	Undefined	--	--	Off	Off
6	Undefined	--	--	Off	Off
7	Undefined	--	--	Off	Off
8	BUSY condition	•Receive buffer-full	•Offline •Receive buffer-full	Off	Off

Table 3.3.4 DIP Switch 2

Switch No.	Function	ON	OFF	Default	
				B	D
1	Selects number of characters per line (cpl) (*)	42 cpl / 35 cpl	40 cpl / 33 cpl	Off	Off
2	Reserved (Autocutter)	Enabled	Disabled	On	Off
3	Undefined	--	--	Off	Off
4	Pin 31 reset signal	Used	Not used	On	On
5	Undefined	--	--	Off	Off
6	Reserved (Flash memory rewriting)	Enabled	Disabled	Off	Off
7	Undefined	--	--	Off	Off
8	Undefined	--	--	Off	Off

(*) Selection of dots between characters: On = 2 half dots, Off = 3 half dots
 The number of characters per line in the Table indicates for the 76 mm-width paper.

EPSON	TITLE TM-U220 series Specification (STANDARD)	SHEET REVISION B	NO.	
			NEXT 61	SHEET 60

3.3.3.2 STD model

1) Serial interface model

Table 3.3.5 DIP Switch 1

Switch No.	Function	ON	OFF	Default		
				A	B	D
1	Data reception error	Ignored	Print “?”	Off	Off	Off
2	Receive buffer capacity	40 bytes	4KB	Off	Off	Off
3	Handshaking	XON/XOFF	DTR/DSR	Off	Off	Off
4	Word length	7 bits	8 bits	Off	Off	Off
5	Parity check	Yes	No	Off	Off	Off
6	Parity selection	Even	Odd	Off	Off	Off
7	Transmission speed selection	4800 bps	9600 bps	Off	Off	Off
8	BUSY condition	•Receive buffer-full	•Offline •Receive buffer-full	Off	Off	Off

Table 3.3.6 DIP Switch 2

Switch No.	Function	ON	OFF	Default		
				A	B	D
1	Selects number of characters per line (cpl) (*)	42 cpl / 35 cpl	40 cpl / 33 cpl	Off	Off	Off
2	Reserved (Autocutter)	Enabled	Disabled	On	On	Off
3	Undefined	--	--	Off	Off	Off
4	Serial communication set selection	By memory switch	By DIP switch	Off	Off	Off
5	Undefined	--	--	Off	Off	Off
6	Reserved (Flash memory rewriting)	Enabled	Disabled	Off	Off	Off
7	Pin 6 reset signal	Used	Not used	Off	Off	Off
8	Pin 25 reset signal	Used	Not used	Off	Off	Off

(*) Selection of dots between characters: On = 2 half dots, Off = 3 half dots

The number of characters per line in the Table indicates for the 76 mm-width paper.

EPSON	TITLE	SHEET REVISION	NO.	
	TM-U220 series Specification (STANDARD)	B	NEXT 62	SHEET 61

2) Parallel interface model

Table 3.3.7 DIP Switch 1

Switch No.	Function	ON	OFF	Default		
				A	B	D
1	Auto line feed	Enabled	Disabled	Off	Off	Off
2	Receive buffer	40 bytes	4KB	Off	Off	Off
3	Undefined	--	--	Off	Off	Off
4	Undefined	--	--	Off	Off	Off
5	Undefined	--	--	Off	Off	Off
6	Undefined	--	--	Off	Off	Off
7	Undefined	--	--	Off	Off	Off
8	BUSY condition	•Receive buffer-full	•Offline •Receive buffer-full	Off	Off	Off

Table 3.3.8 DIP Switch 2

Switch No.	Function	ON	OFF	Default		
				A	B	D
1	Selects number of characters per line (cpl) (*)	42 cpl / 35 cpl	40 cpl / 33 cpl	Off	Off	Off
2	Reserved (Autocutter)	Enabled	Disabled	On	On	Off
3	Undefined	--	--	Off	Off	Off
4	Undefined	--	--	Off	Off	Off
5	Undefined	--	--	Off	Off	Off
6	Reserved (Flash memory rewriting)	Enabled	Disabled	Off	Off	Off
7	Undefined	--	--	Off	Off	Off
8	Pin 31 reset signal	Used	Not used	On	On	On

(*) Selection of dots between characters: On = 2 half dots, Off = 3 half dots
 The number of characters per line in the Table indicates for the 76 mm-width paper.

EPSON	TITLE	SHEET REVISION	NO.	
	TM-U220 series Specification (STANDARD)	B	NEXT 63	SHEET 62

3.3.4 Memory switches

The memory switches covers the following settings:

- Function of the memory switches Msw2, Msw8
- Customized values
- Communication conditions of the serial interface

1) Memory switches

Table 3.3.9 Memory Switch Msw2

Switch No.	Function	48 (Off)	49 (On)	Default
1	Undefined	--	--	Off
2	Undefined	--	--	Off
3	Selection of the character code system of the Simplified Chinese	GB18030	GB2312	Off
4	Undefined	--	--	Off
5	Undefined	--	--	Off
6	Undefined	--	--	Off
7	Undefined	--	--	Off
8	Undefined	--	--	Off

Table 3.3.10 Memory Switch Msw8

Switch No.	Function	48 (Off)	49 (On)	Default
1	Undefined	--	--	Off
2	Undefined	--	--	Off
3	Undefined	--	--	Off
4	Undefined	--	--	Off
5	Selection of the cover open status	Paper end	Cover open	Off
6	Undefined	Fixed to Off	--	Off
7	Condition to release the BUSY in the receive buffer	Remaining 256 bytes	Remaining 138 bytes	Off
8	Printer cover open during operation	Errors that automatically recover	Errors that can possibly recover	Off

Msw8-5: When Off is selected, a bit of the “roll paper end sensor” in each status that is transmitted from the printer is changed every time the roll paper cover is open or closed.

When On is selected, a bit of the “roll paper cover open / close” in each status that is transmitted from the printer is changed every time the roll paper cover is open or closed.

Msw8-8: When Off is selected, a bit of the “automatic recoverable error” in each status that is transmitted from the printer is changed every time the roll paper cover is open.

When On is selected, a bit of the “mechanical error” in each status that is transmitted from the printer is changed every time the roll paper cover is open.

EPSON	TITLE	SHEET REVISION	NO.	
	TM-U220 series Specification (STANDARD)	B	NEXT 64	SHEET 63

2) Customized value

The customized value is set with the **GS (E** command.

Function	Value	
Selection of the paper width	57.5 mm	69.5 mm
	76 mm	--

3) Communication conditions of the serial interface

The communication conditions of the serial interface are set with the **GS (E** command.

Function	Value	
Baud rate	1200 bps	2400 bps
	4800 bps	9600 bps
	19200 bps	--
Parity	None	Odd
	Even	--
Handshaking	DSR/DTR control	XON/XOFF control
Data length	7 bits	8 bits

EPSON	TITLE TM-U220 series Specification (STANDARD)	SHEET REVISION B	NO.	
			NEXT 65	SHEET 64

3.4 Panel LED Indicators

3.4.1 Panel LED indicators

- 1) Power supply (POWER) LED: Green
 - On: Power supply is stable.
 - Off: Power supply is not stable.

- 2) Roll paper end (PAPER OUT) LED: Red
 - On: The roll paper near end (*1) or real end is detected.
 - Off: Paper is loaded (normal condition).
 - Flashing: Self-test waiting state for test print.

Table 3.4.1 Standby State Indication

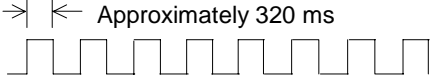
State	PAPER LED flashing pattern	Recovery conditions
Waiting for self-test printing to be continued.	PAPER OUT 	Pressing the FEED button causes self-test printing to be continued.

*1: The roll paper near-end sensor is available as an option. If the printer is not equipped with the roll paper near-end sensor, the roll paper near-end is always detected as the paper presence.

- 3) Error (ERROR) LED: Red
 - On: Offline (except during paper feeding using the FEED button and during the self-test).
 - Flashing: Error state. (See Section 3.5, Error Processing.)
 - Off: Normal operation



Figure 3.4.1 Panel Switches and Indicators

EPSON	TITLE	SHEET REVISION	NO.	
	TM-U220 series Specification (STANDARD)	B	NEXT 66	SHEET 65

3.5 Error Processing

3.5.1 Error types

1) Error that recovers automatically

Table 3.5.1 Automatically Recoverable Error

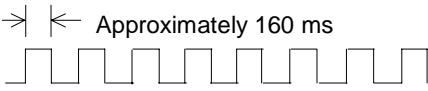
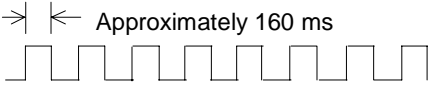
Error	Description	ERROR LED flashing pattern	Recovery
Roll paper cover open error (when recoverable error is selected) (*1)	Printing on the roll paper is not performed correctly due to a cover-open		Recovers automatically when the cover is closed.
Print head temperature error (*2)	The temperature of the print head is extremely high.		Recovers automatically when the print head cools.

NOTES: *1: The printer cover open error operation can be selected with the memory switch.

*2: If an abnormal temperature is detected, the printer generates a print head temperature error as an unrecoverable error.

- A print head temperature error is not abnormal.

2) Errors can be recovered with a command

Table 3.5.2 Errors Where Recovery is Possible

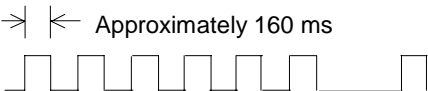
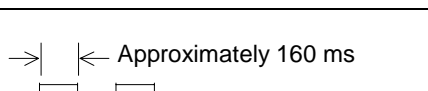
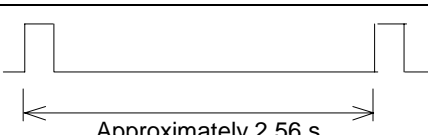
Error	Description	ERROR LED flashing pattern	Recovery
Roll paper cover open error (when an error that may possibly recover is selected) (*1)	Printing on the roll paper is not performed correctly due to a cover-open.		Recovers by DLE ENQ 1 or DLE ENQ 2 when the cover is closed.
Home position detection error (mechanical error)	Home position cannot be detected due to a paper jam or other problem.		Recovers using DLE ENQ 2 .
Autocutter error (for type B and type A) (*2)	Abnormality in the autocutter.		Recovers using DLE ENQ 2 .



NOTES: *1: The printer cover open error operation can be selected with a memory switch.

*2: When an autocutter error occurs caused by jamming paper, turn the power off and remove the jammed paper, then turn the power on again.

EPSON	TITLE	SHEET REVISION	NO.	
	TM-U220 series Specification (STANDARD)	B	NEXT 67	SHEET 66

3) Errors that cannot be recovered

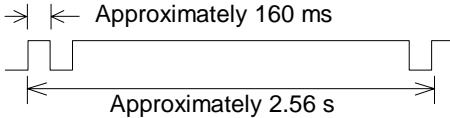
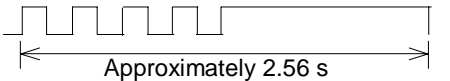
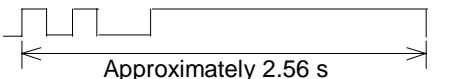
Table 3.5.3 Unrecoverable Errors

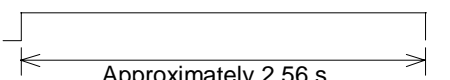
Error	Description	ERROR LED flashing pattern	Recovery
R/W error in memory	After R/W checking, the printer does not work correctly.		Impossible to recover.
CPU execution error	CPU executes an incorrect address.		Impossible to recover.
High voltage error	Power voltage is extremely high.		Impossible to recover.
Low voltage error	Power voltage is extremely low.		Impossible to recover.
Print head temperature detection circuit error	Abnormality in the print head temperature.		Impossible to recover.

NOTE: If an error that cannot be recovered occurs, turn off the power as soon as possible.

3.5.2 Operation when an error is detected

The printer executes the following operations when detecting an error:

<Serial interface model>

- Stops all mechanical operations.
- Sets the DTR signal to MARK.
- Flashes the ERROR LED
- Transmits XOFF if XON/XOFF control is selected.

<Parallel interface model>

- Stops all mechanical operations.
- Sets the Busy signal to HIGH.
- Flashes the ERROR LED.
- Sets the nFault signal to LOW.

3.5.3 Data reception error

If any of the following data reception errors occur during serial interface communication, the printer prints “ ? ” or ignores the data, according to the setting of DIP switch.

- Parity error
- Framing error
- Overrun error

EPSON	TITLE	SHEET REVISION	NO.	
	TM-U220 series Specification (STANDARD)	B	NEXT 68	SHEET 67

3.6 Self-test

- 1) The printer has a self-test function that checks the following:
- Control circuit functions
 - Printer mechanisms
 - Print quality
 - Control software version
 - Contents of the DIP switch settings
 - Memory switch settings
 - Paper width to be set

2) Executing the self-test

[Starting the self-test]

To start the self-test on roll paper, hold down the FEED button and turn on the printer with the cover closed, or execute the **GS (A** command; then the current printer status (*1) is printed.

- (*1) • Control software version
- Contents of the DIP switch settings
 - Memory switch settings

[Self-test standby state]

After printing the current printer status, the printer prints the message "If you want to continue SELF-TEST printing, please press FEED button." The PAPER OUT LED indicator flashes and the printer enters the test printing (*2) standby state. Press the FEED button to start test printing.

- (*2) • Prints a rolling pattern using only the built-in character set
- Cuts automatically after completing the rolling pattern printing (for type A and B)

3) Ending the self-test

After a number of lines are printed, the printer indicates the end of the self-test by printing "**** completed ***, " and initializes.

EPSON	TITLE	TM-U220 series Specification (STANDARD)	SHEET REVISION	NO.	
			B	NEXT 69	SHEET 68

3.7 Hexadecimal Dumping

1) Hexadecimal dumping function

This function prints the data transmitted from the host computer in hexadecimal numbers and in their corresponding characters.

2) Starting hexadecimal dumping

Open the cover and turn the power on while pressing the paper FEED button (located inside the printer) or executing the **GS (A** command; then close the cover. The printer first prints "Hexadecimal Dump To terminate ..." on the roll paper and prints the received print data in hexadecimal numbers and in their corresponding characters.

- NOTES:
1. If a character does not correspond to the data received, the printer prints ".".
 2. During hexadecimal dumping, any commands other than **DLE EOT**, **DLE ENQ**, and **DLE DC4** do not function.
 3. Insufficient print data to fill the last line can be printed by pressing the paper FEED button.

3) Ending hexadecimal dumping

Hexadecimal dumping ends by turning the power off, pressing the paper FEED button three times, or resetting the printer after printing has finished.

<Printing example>

<pre>Hexadecimal Dump To terminate hexadecimal dump, press FEED button three times. 1B 40 1B 21 30 41 42 43 .@.!0ABC 44 45 46 47 0A 41 42 43 DEFG..BC *** completed ***</pre>

EPSON	TITLE	TM-U220 series Specification (STANDARD)	SHEET REVISION	NO.	
			B	NEXT 70	SHEET 69

3.8 Memory Switch Setting Mode

1) Memory switch setting functions

The following memory switches can be set by operating the button and opening and closing the cover.

- ① Selection of the printer status when opening the cover
- ② Conditions for releasing the receive buffer BUSY
- ③ Setting of the paper width
- ④ Conditions for serial interface communication

2) Starting the memory switch setting mode

Open the cover and turn the power on while holding down the paper FEED button (located inside the printer), and continue holding down the paper FEED button until the ERROR LED light is on; release the paper FEED button when the ERROR LED light is on. Next, press the paper FEED button twice, and close the cover. Then, the printer prints the possible setting contents of the memory switch and instructions. Follow the instructions to set the memory switches.

3) Ending the memory switch setting mode

Once the setting is performed, the contents of the settings are stored; then the printer executes the initialization. After initializing, the printer enters the normal state.

EPSON	TITLE TM-U220 series Specification (STANDARD)	SHEET REVISION B	NO.	
			NEXT 71	SHEET 70

3.9 Paper Sensors

The printer has the following paper sensors:

- Roll paper end sensor
- Roll paper near-end sensor (optional)

3.9.1 Sensors and LED indicators

1) Roll paper end sensor

This sensor is located in the roll paper path. This sensor detects paper out. When the paper end is detected, the PAPER OUT LED lights. However, if the roll paper core and paper are attached to each other by tape or glue, the paper end cannot be detected. When the printer detects the paper end, stop printing and exchange the roll paper with a new one. (The roll paper end sensor enables the roll paper loading automatically.)

2) Roll paper near-end sensor (optional)

This sensor is installed on the roll paper supply device. It detects a paper near-end by monitoring the roll paper diameter. The PAPER OUT LED lights and the internal buzzer beeps when the roll paper diameter becomes sufficiently small.

3.9.2 Sensors and printing

When the printer detects a paper near-end, it stops or continues printing, depending on the **ESC c 4** command setting. The roll paper sensor always halts printing when there is no paper.

3.10 Buffer-full Printing

When subsequent data is received after the printer processes one line of data in the print buffer, the printer automatically prints the processed line and feeds the paper by one line.

3.11 Roll Paper Cover Open Lever

When the roll paper cover open lever is pulled, the roll paper cover is opened. When the roll paper cover is closed, the internal hook is latched.

- NOTES:
- Be sure to use the roll paper cover open button to open the roll paper cover.
 - Do not open the roll paper cover during printing.
 - Do not open the roll paper cover during the autcutting operation; otherwise the mechanism may be damaged.

EPSON	TITLE	SHEET REVISION	NO.	
	TM-U220 series Specification (STANDARD)	B	NEXT 72	SHEET 71

3.12 Roll Paper Cover Open Sensor

The roll paper cover open sensor monitors the printer cover. When the sensor detects a roll paper cover open during printing, the printer enters an error state, stops printing and goes offline automatically. The printer recovers to online when the roll paper cover is closed.

When automatic error recovery is selected:
 If the printer detects the roll paper cover open during printing, the error LED flashes. When the roll paper cover is closed, the error LED turns off, and the printer initializes by itself and starts printing from the beginning of the line that stopped printing.

When possible error recovery is selected:
 When the roll paper cover is closed, the printer recovers upon receipt of **DLE ENQ 2**. If the roll paper cover is open during standby, the printer goes offline. When the roll paper cover is closed, the printer recovers to online.

NOTE: Whether the roll paper cover is open or not does not affect the status reported by the roll paper end sensor.

When the paper-end stop is selected with the memory switch Msw8-5:
 When the roll paper cover is open, the printer recognizes a paper-end; when the roll paper cover is closed, the printer recognizes a paper presence.

EPSON	TITLE TM-U220 series Specification (STANDARD)	SHEET REVISION B	NO.	
			NEXT 73	SHEET 72

4. CASE SPECIFICATIONS

4.1 External Dimensions and Mass

Model type	External Dimensions			Mass
	Width	Height	Depth	
A	160 mm {Approximately 6.3"}	157.5 mm {Approximately 6.2"}	286 mm {Approximately 11.3"}	Approximately 2.7 kg {5.9 lb}
B	160 mm {Approximately 6.3"}	138.5 mm {Approximately 5.5"}	248 mm {Approximately 9.8"}	Approximately 2.5 kg {5.5 lb}
D	160 mm {Approximately 6.3"}	138.5 mm {Approximately 5.5"}	248 mm {Approximately 9.8"}	Approximately 2.3 kg {5.1 lb}

4.2 Color

EPSON standard color (ECW, EDG)

EPSON	TITLE TM-U220 series Specification (STANDARD)	SHEET REVISION B	NO.	
			NEXT 74	SHEET 73

4.3 External Appearance

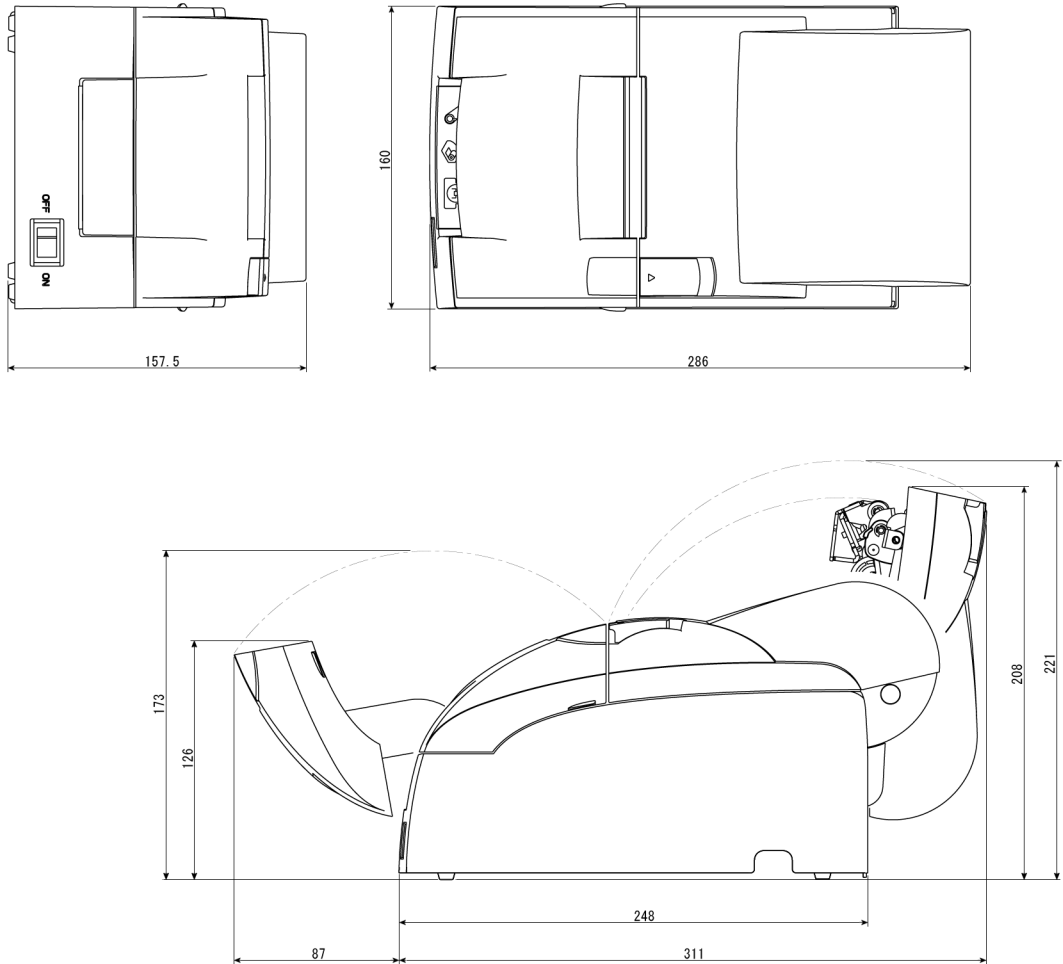

[Units: mm]

Figure 4.3.1 External Appearance (Type A)

EPSON	TITLE	TM-U220 series Specification (STANDARD)	SHEET REVISION	NO.	
			B	NEXT 75	SHEET 74

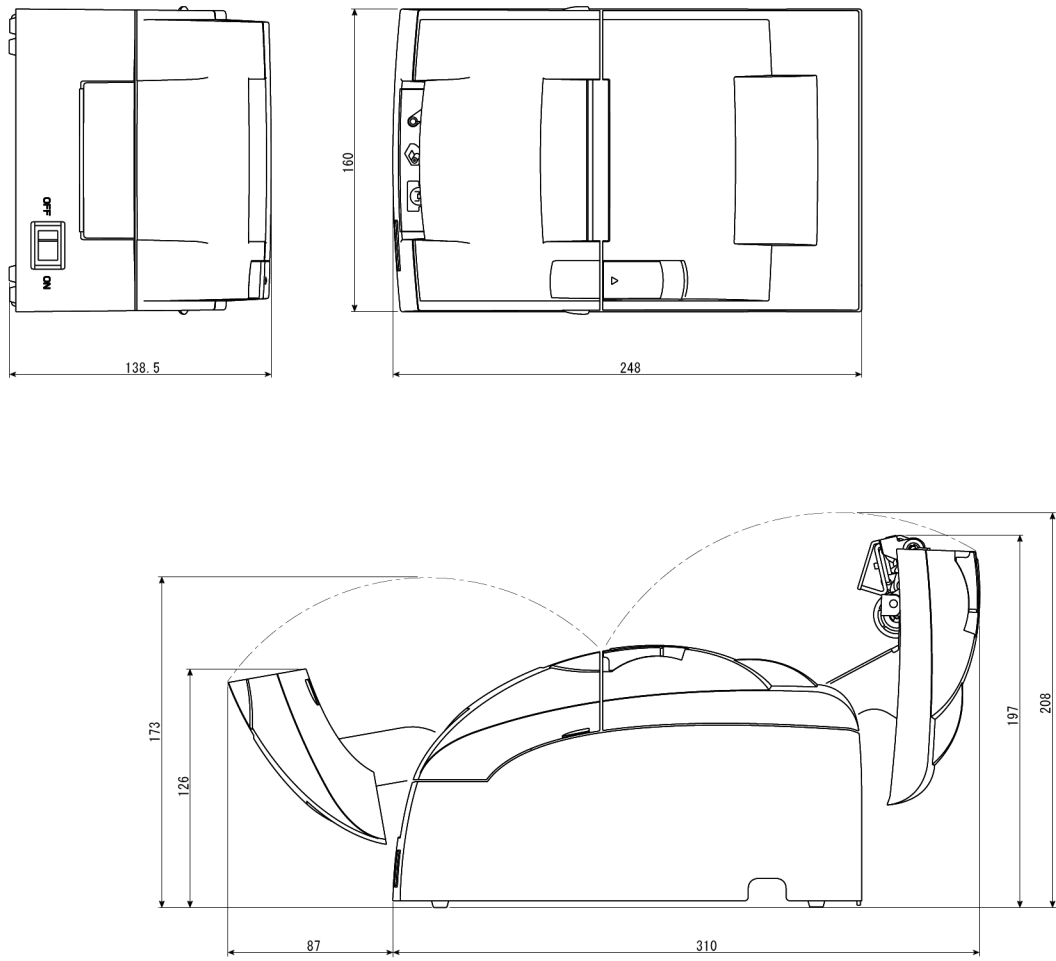

[Units: mm]

Figure 4.3.2 External Appearance (Type B)

EPSON	TITLE TM-U220 series Specification (STANDARD)	SHEET REVISION B	NO.	
			NEXT 76	SHEET 75

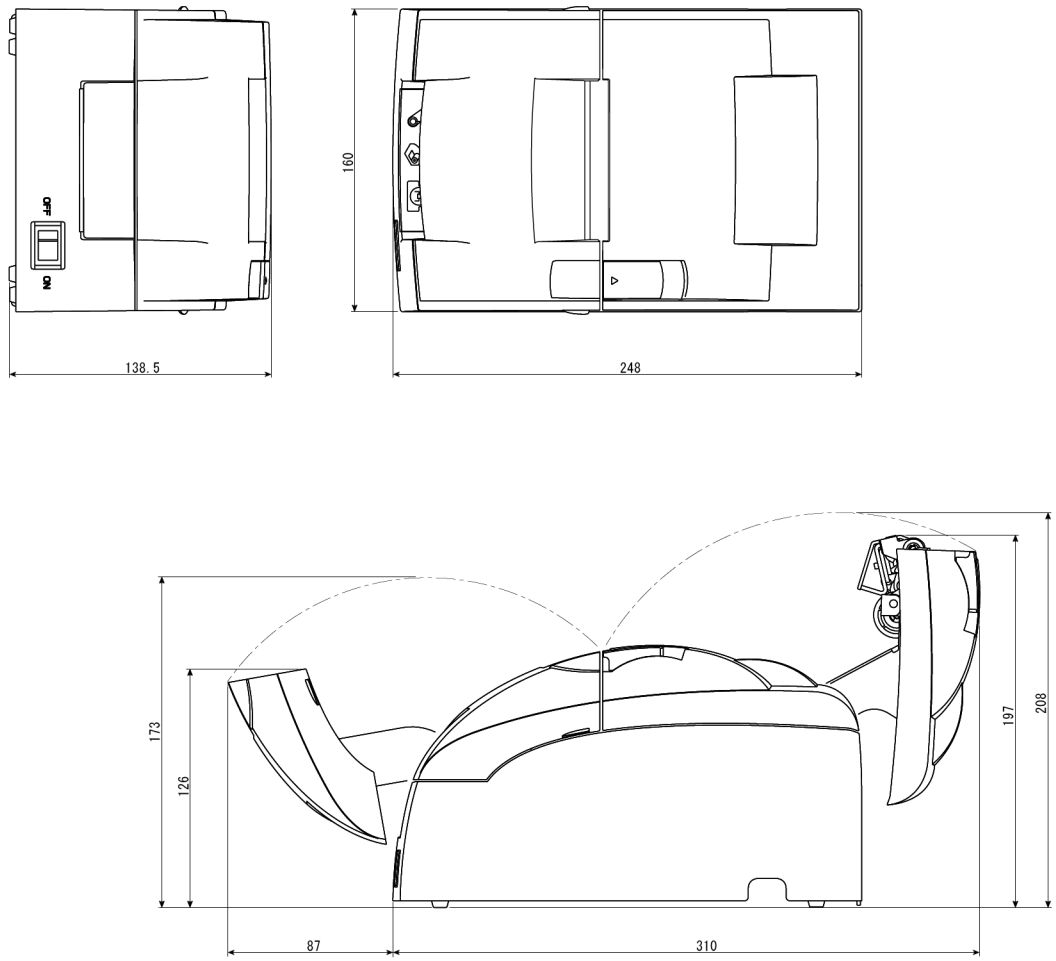

[Units: mm]

Figure 4.3.3 External Appearance (Type D)

EPSON	TITLE	TM-U220 series Specification (STANDARD)	SHEET REVISION	NO.	
			B	NEXT 77	SHEET 76

5. OPTIONS AND CONSUMABLES

5.1 Standard Accessories

- Dedicated ribbon cassette (ERC-38(B/R))
- Roll paper
- User's manual (Languages: English, German, French, Spanish, Portuguese, Italian, Dutch, Simplified Chinese, Traditional Chinese, Japanese)
- Power supply unit
 - ANK model: AC adapter C
 - Multilingual model: PS-180

5.1.1 External size and mass of Power Supply Unit

1) External size and mass:

	External size			Mass
	Width	Height	Depth	
AC adapter, C	54 mm	36 mm	114 mm	Approximately 0.4 kg
PS-180	68 mm	32 mm	136 mm	Approximately 0.4 kg

2) AC cable:

This power supply unit does not include an AC cable. Use an AC cable that meets the specifications below.

- Meets the safety standards
 - Includes a PE (power ground) terminal in the plug
- TCP0927-63-1110 (Hoshiden) or equivalent

DC cable connector:

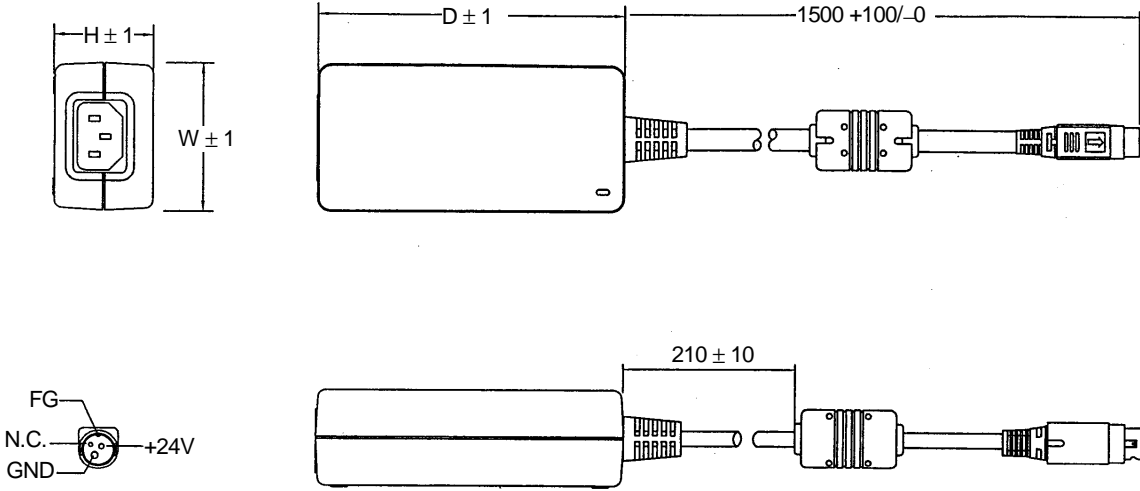

Figure 5.1.1 External Size of Power Supply Unit

3) Grounding:

Make sure to ground the product for safety.

EPSON	TITLE	TM-U220 series Specification (STANDARD)	SHEET REVISION	NO.	
			B	NEXT 78	SHEET 77

5.2 Options

- Roll paper near-end sensor (factory option)
- Affixing Velcro® tape (model: DF-10)
- Wall hanging bracket (model: WH-10) (planned)
- Various interface boards (EPSON UB series, except UB-S03 and UB-U01/U02/U05/U06/U19) can be used. (However, current plans are to support only UB-S02.)

EPSON	TITLE TM-U220 series Specification (STANDARD)	SHEET REVISION B	NO.	
			NEXT 79	SHEET 78

6. COMMANDS

6.1 Command Notation

XXXX

[Name]	The name of the command.
[Format]	The code sequence. [/]k indicates the contents of the [] should be repeated k times.
[Range]	Gives the allowable ranges, if any, for the arguments.
[Default]	Gives the default values, if any, for the command parameters.
[Description]	Describes the function of the command. "–" in the table indicates 0 or 1.
[Notes]	Provides important information on setting and using the printer command, if necessary.
[Reference]	Gives the reference, if any.

6.2 Explanation of Terms

1) Real-time command

Real-time commands are identified with a **DLE** extension such as **DLE EOT**, **DLE ENQ** or **DLE DC4**. The printer executes these commands as soon as they are received.

2) Obsolete command

Obsolete commands are commands that will not be supported by future printer models. Therefore, we recommend replacing them with more recent, upward-compatible commands that have the same functions.

3) NV memory write command

NV memory write commands deletes or stores data in the NV memory (flash ROM)

GS (C <some functions>, **GS (E <some functions>**, **FS q**

4) ESC/ POS handshaking protocol

ESC/ POS handshaking protocol is a handshaking protocol between the host PC and the printer when the printer transmits data. The ESC/ POS handshaking protocol is required if the following commands are executed:

GS (C <some functions>

5) Print buffer

The print buffer is used to store image data for printing

6) Receive buffer

The receive buffer is used to store data from the host computer. All received data is stored in this buffer and processed in the order received. Buffer capacity depends on the printer model used.

7) The horizontal or vertical motion units

The horizontal or vertical motion units are used for calculating the setting values for various commands and are [Horizontal direction: 0.159 mm {1/160 inches} / Vertical direction: 0.176 mm {1/144 inches}].

EPSON	TITLE TM-U220 series Specification (STANDARD)	SHEET REVISION B	NO.	
			NEXT 80	SHEET 79

Confidential

8) The left edge of the printing area

The left edge of the printing area indicates the first column for character(s) to be developed.

9) Column format

Column format is a format that data is set in descending order (bit 7, 6, ..., 0) from the top vertically.

<i>d1</i>	<i>d4</i>	<i>d7</i>	MSB
			LSB
<i>d2</i>	<i>d5</i>	<i>d8</i>	MSB
			LSB
<i>d3</i>	<i>d6</i>	<i>d9</i>	MSB
			LSB

10) Inch

A unit of length. One inch is 25.4 mm.

11) dpi

dpi (dots per inch) is the number of dots per 25.4 mm.

EPSON	TITLE TM-U220 series Specification (STANDARD)	SHEET REVISION B	NO.	
			NEXT 81	SHEET 80

6.3 Control Commands

HT

[Name] Horizontal tab
[Format] ASCII HT
Hex 09
Decimal 9

[Description] • Moves the printing position to the next horizontal tab position.

LF

[Name] Print and line feed
[Format] ASCII LF
Hex 0A
Decimal 10

[Description] • Prints the data in the print buffer and feeds one line, based on the current line spacing.

CR

[Name] Print and carriage return
[Format] ASCII CR
Hex 0D
Decimal 13

[Description] • Executes one of the following operations.

Condition	Function
When automatic line feed is enabled	Functions the same as LF
When automatic line feed is disabled and when using serial interface model	Prints the data in the print buffer, and sets the printing position to the beginning of the print line.

EPSON	TITLE TM-U220 series Specification (STANDARD)	SHEET REVISION B	NO.	
			NEXT 82	SHEET 81

DLE EOT *n*

[Name] Transmit real-time status
 [Format] ASCII DLE EOT *n*
 Hex 10 04 *n*
 Decimal 16 4 *n*
 [Range] $1 \leq n \leq 4$
 [Description] • Transmits the real-time status.

<i>n</i>	Function
1	Transmits printer status in real time.
2	Transmits offline cause status.
3	Transmits error cause status.
4	Transmits roll paper sensor status.

- This printer transmits the following status in real time.
- Printer status ($n = 1$)

Bit	Off/On	Hex	Decimal	Status
0	Off	00	0	Fixed.
1	On	02	2	Fixed.
2	Off	00	0	Drawer kick out connector pin 3 is LOW.
	On	04	4	Drawer kick out connector pin 3 is HIGH.
3	Off	00	0	Online.
	On	08	8	Offline.
4	On	10	16	Fixed.
5, 6	--	--	--	Reserved.
7	Off	00	0	Fixed.

- Offline cause status ($n = 2$)

Bit	Off/On	Hex	Decimal	Status
0	Off	00	0	Fixed.
1	On	02	2	Fixed.
2	Off	00	0	The roll paper cover is closed.
	On	04	4	The roll paper cover is opened.
3	Off	00	0	Paper is not being fed by the paper FEED button.
	On	08	8	Paper is being fed by the paper FEED button.
4	On	10	16	Fixed.
5	Off	00	0	No paper-end stop.
	On	20	32	Printing stops due to paper end.
6	Off	00	0	No error.
	On	40	64	Error.
7	Off	00	0	Fixed.

EPSON	TITLE TM-U220 series Specification (STANDARD)	SHEET REVISION B	NO.	
			NEXT 83	SHEET 82

• Error cause status ($n = 3$)

Bit	Off/On	Hex	Decimal	Status
0	Off	00	0	Fixed.
1	On	02	2	Fixed.
2	Off	00	0	No mechanical error.
	On	04	4	Mechanical error.
3	Off	00	0	No autocutter error.
	On	08	8	Autocutter error.
4	On	10	16	Fixed.
5	Off	00	0	No unrecoverable error.
	On	20	32	Unrecoverable error.
6	Off	00	0	No automatically recoverable error.
	On	40	64	Automatically recoverable error.
7	Off	00	0	Fixed.

• Roll paper sensor status ($n = 4$)

Bit	Off/On	Hex	Decimal	Status
0	Off	00	0	Fixed.
1	On	02	2	Fixed.
2, 3	Off	00	0	Roll paper near-end sensor: paper adequate.
	On	0C	12	Roll paper near-end sensor: paper near end.
4	On	10	16	Fixed.
5, 6	Off	00	0	Roll paper end sensor: paper present.
	On	60	96	Roll paper end sensor: paper not present.
7	Off	00	0	Fixed.

Bits 2 and 3: The roll paper near-end sensor is an option: on units that do not have this option, bits 2 and 3 are "0" (paper adequate).

[Notes]

- Take the following into consideration:
 - If print data includes a character string matching this command, the printer performs this command. Users must consider this.
For example: Bit image data might accidentally include a data string matching this command.
 - Do not embed this command within another command.
For example: Bit image data might include this command.
- Transmit this command according to the following method:
 - When one real-time status command is transmitted, any following real-time status command must not be transmitted until the first status is received.
 - However, if the real-time commands are required to transmit continuously, it is possible to transmit up to eight real-time commands at once.
In this case, the following data must not be transmitted until the all status information is received.
If real-time commands are transmitted without using the above method, the status may not be received.

EPSON	TITLE TM-U220 series Specification (STANDARD)	SHEET REVISION B	NO.	
			NEXT 84	SHEET 83

DLE ENQ *n*

[Name] Send real-time request to printer

[Format] ASCII DLE ENQ *n*
 Hex 10 05 *n*
 Decimal 16 5 *n*

[Range] $n = 2$

[Description] • Responds to a request from the host computer.

<i>n</i>	Function
2	Recovers from an error after clearing the receive and print buffers. • This command is ignored unless the unrecoverable error has occurred.

- [Notes]
- Specify ($n = 2$) after removing the cause of the error.
 - Take the following into consideration:
 - If print data includes a character string matching this command, the printer performs the command. Users must consider this.
 For example: Bit image data might accidentally include a data string matching this command.
 - Do not embed this command within another command.
 For example: Bit image data might include this command.

DLE DC4 *fn m t* ($fn = 1$)

[Name] Generate pulse in real-time

[Format] ASCII DLE DC4 *fn m t*
 Hex 10 14 *fn m t*
 Decimal 16 20 *fn m t*

[Range] $fn = 1$
 $m = 0, 1$
 $1 \leq t \leq 8$

[Description] • Outputs the pulse specified by *t* in real-time to the connector pin specified by *m*.

<i>m</i>	Connector pin
0	Drawer kick out connector pin 2.
1	Drawer kick out connector pin 5.

- [Notes]
- The pulse on time or off time is set to ($t \times 100$ ms).
 - Take the following into consideration:
 - If print data includes a character string with this command, the printer performs the command. Users must consider this.
 For example: Bit image data might accidentally include a data string matching this command.
 - Do not embed this command within another command.
 For example: Bit image data might include this command.

EPSON	TITLE	SHEET REVISION	NO.	
	TM-U220 series Specification (STANDARD)	B	NEXT 85	SHEET 84

ESC SP *n*

[Name] Set right-side character spacing

[Format]	ASCII	ESC	SP	<i>n</i>
	Hex	1B	20	<i>n</i>
	Decimal	27	32	<i>n</i>

[Range] $0 \leq n \leq 255$ [Default] $n = 0$ [Description] • Sets the character spacing for the right side of the character to [$n \times$ (horizontal motion unit)].**ESC ! *n***

[Name] Select print mode(s)

[Format]	ASCII	ESC	!	<i>n</i>
	Hex	1B	21	<i>n</i>
	Decimal	27	33	<i>n</i>

[Range] $0 \leq n \leq 255$ [Default] $n = 1$

[Description] • Selects the character font and styles (emphasized, double-height, double-width, and underlined) together.

(<i>n</i>) Bit	Off/On	Hex	Decimal	Function
0	Off	00	0	Character Font A (9 × 9) selected.
	On	01	1	Character Font B (7 × 9) selected.
1, 2	Off	00	0	Reserved.
3	Off	00	0	Emphasized mode not selected.
	On	08	8	Emphasized mode selected.
4	Off	00	0	Double-height mode not selected.
	On	10	16	Double-height mode selected.
5	Off	00	0	Double-width mode not selected.
	On	20	32	Double-width mode selected.
6	Off	00	0	Reserved.
7	Off	00	0	Underline mode not selected.
	On	80	128	Underline mode selected.

EPSON

TITLE

TM-U220 series
 Specification
 (STANDARD)
SHEET
REVISION

B

NO.

NEXT
86SHEET
85

ESC % *n*

[Name]	Select/cancel user-defined character set												
[Format]	<table style="border-collapse: collapse; margin-left: 20px;"> <tr> <td style="padding-right: 10px;">ASCII</td> <td style="padding-right: 10px;">ESC</td> <td style="padding-right: 10px;">%</td> <td style="padding-right: 10px;"><i>n</i></td> </tr> <tr> <td>Hex</td> <td>1B</td> <td>25</td> <td><i>n</i></td> </tr> <tr> <td>Decimal</td> <td>27</td> <td>37</td> <td><i>n</i></td> </tr> </table>	ASCII	ESC	%	<i>n</i>	Hex	1B	25	<i>n</i>	Decimal	27	37	<i>n</i>
ASCII	ESC	%	<i>n</i>										
Hex	1B	25	<i>n</i>										
Decimal	27	37	<i>n</i>										
[Range]	$0 \leq n \leq 255$												
[Default]	$n = 0$												
[Description]	<ul style="list-style-type: none"> • Selects or cancels the user-defined character set. • When the LSB of <i>n</i> is 0, the user-defined character set is canceled. • When the LSB of <i>n</i> is 1, the user-defined character set is selected. 												

ESC & *y c1 c2 [x1 d1...d(yxx1)]...[xk d1...d(yxxk)]*

[Name]	Define user-defined characters																					
[Format]	<table style="border-collapse: collapse; margin-left: 20px;"> <tr> <td style="padding-right: 10px;">ASCII</td> <td style="padding-right: 10px;">ESC</td> <td style="padding-right: 10px;">&</td> <td style="padding-right: 10px;"><i>y</i></td> <td style="padding-right: 10px;"><i>c1</i></td> <td style="padding-right: 10px;"><i>c2</i></td> <td style="padding-right: 10px;"><i>[x1 d1...d(yxx1)]...[xk d1...d(yxxk)]</i></td> </tr> <tr> <td>Hex</td> <td>1B</td> <td>26</td> <td><i>y</i></td> <td><i>c1</i></td> <td><i>c2</i></td> <td><i>[x1 d1...d(yxx1)]...[xk d1...d(yxxk)]</i></td> </tr> <tr> <td>Decimal</td> <td>27</td> <td>38</td> <td><i>y</i></td> <td><i>c1</i></td> <td><i>c2</i></td> <td><i>[x1 d1...d(yxx1)]...[xk d1...d(yxxk)]</i></td> </tr> </table>	ASCII	ESC	&	<i>y</i>	<i>c1</i>	<i>c2</i>	<i>[x1 d1...d(yxx1)]...[xk d1...d(yxxk)]</i>	Hex	1B	26	<i>y</i>	<i>c1</i>	<i>c2</i>	<i>[x1 d1...d(yxx1)]...[xk d1...d(yxxk)]</i>	Decimal	27	38	<i>y</i>	<i>c1</i>	<i>c2</i>	<i>[x1 d1...d(yxx1)]...[xk d1...d(yxxk)]</i>
ASCII	ESC	&	<i>y</i>	<i>c1</i>	<i>c2</i>	<i>[x1 d1...d(yxx1)]...[xk d1...d(yxxk)]</i>																
Hex	1B	26	<i>y</i>	<i>c1</i>	<i>c2</i>	<i>[x1 d1...d(yxx1)]...[xk d1...d(yxxk)]</i>																
Decimal	27	38	<i>y</i>	<i>c1</i>	<i>c2</i>	<i>[x1 d1...d(yxx1)]...[xk d1...d(yxxk)]</i>																
[Range]	$y = 2$ $32 \leq c1 \leq c2 \leq 126$ $0 \leq x \leq 12$ (when Font A (9 × 9) is selected) $0 \leq x \leq 10$ (when Font B (7 × 9) is selected) $0 \leq d \leq 255$ $k = c2 - c1 + 1$																					
[Description]	<ul style="list-style-type: none"> • Assigns the user-defined character pattern for the specified character codes. • <i>y</i> specifies the number of bytes in the vertical direction. • <i>c1</i> specifies the beginning character code for the definition, and <i>c2</i> specifies the final code. • <i>x</i> specifies the number of dots in the horizontal direction. • <i>d</i> specifies the defined data (column format) 																					
[Notes]	<ul style="list-style-type: none"> • The maximum number of characters for font A and B that can be defined is 20 each. • When the maximum number of user-defined characters is defined, it is possible to redefine user-defined characters for the defined ASCII code, but not for the new ASCII code. 																					

EPSON	TITLE	SHEET REVISION	NO.	
	TM-U220 series Specification (STANDARD)	B	NEXT 87	SHEET 86

ESC * m nL nH d1...dk

[Name] Select bit-image mode
 [Format] ASCII ESC * m nL nH d1...dk
 Hex 1B 2A m nL nH d1...dk
 Decimal 27 42 m nL nH d1...dk
 [Range] $m = 0, 1$
 $1 \leq (nL + nH \times 256) \leq 1023$ ($0 \leq nL \leq 255, 0 \leq nH \leq 3$)
 $0 \leq d \leq 255$
 $k = nL + nH \times 256$

[Description] • Stores the bit image data in *m* mode in the print buffer.

<i>m</i>	Bit image mode	Vertical Dot Density	Horizontal Dot Density
0	8-dot single-density	60 dpi	90 dpi
1	8-dot double-density	60 dpi	180 dpi

- *nL, nH* specify the horizontal size as $(nL + nH \times 256)$ dots.
- *d* specifies the bit image data (column format).

ESC - n

[Name] Turn underline mode on/off
 [Format] ASCII ESC - n
 Hex 1B 2D n
 Decimal 27 45 n

[Range] $0 \leq n \leq 2, 48 \leq n \leq 50$

[Default] $n = 0$

[Description] • Turns underline mode on or off.

<i>n</i>	Function
0, 48	Turns off underline mode.
1, 49	Turns on underline mode.
2, 50	

ESC 2

[Name] Select default line spacing
 [Format] ASCII ESC 2
 Hex 1B 32
 Decimal 27 50

[Description] • Sets the current line spacing to approximately 4.23 mm {1/6"}.

EPSON	TITLE	SHEET REVISION	NO.	
	TM-U220 series Specification (STANDARD)	B	NEXT 88	SHEET 87

ESC 3 n

[Name] Set line spacing
 [Format] ASCII ESC 3 n
 Hex 1B 33 n
 Decimal 27 51 n
 [Range] $0 \leq n \leq 255$
 [Default] $n = 24$ (Equivalent to approximately 4.23 mm {1/6"}.)
 [Description] • Sets the current line spacing to $[n \times (\text{vertical motion unit})]$.

ESC <

[Name] Return home
 [Format] ASCII ESC <
 Hex 1B 3C
 Decimal 27 60
 [Description] • Moves the print head to the standby position.

ESC = n

[Name] Select peripheral device
 [Format] ASCII ESC = n
 Hex 1B 3D n
 Decimal 27 61 n
 [Range] $1 \leq n \leq 3$
 [Default: When turning on the printer]
 $n = 1$
 [Default: When executing ESC @]

	<i>n</i>		
Setting before ESC @ processing	1	2	3
After ESC @ Processing	1	2	1

[Description] • Selects device to which the host computer transmits data.

<i>n</i>	Function
1	Specifies printer only.
2	Specifies customer display only.
3	Specifies printer and customer display.

• When the customer display only is selected, specified by ($n = 2$), all data except this command and the real-time commands are ignored.

EPSON	TITLE	SHEET REVISION	NO.	
	TM-U220 series Specification (STANDARD)	B	NEXT 89	SHEET 88

ESC ? n

[Name] Cancel user-defined characters

[Format] ASCII ESC ? n
 Hex 1B 3F n
 Decimal 27 63 n

[Range] $32 \leq n \leq 126$

[Description] • Cancels the user-defined character pattern for the specified character codes.
 • n specifies the character code for which the pattern defined is to be canceled.

ESC @

[Name] Initialize printer

[Format] ASCII ESC @
 Hex 1B 40
 Decimal 27 64

[Description] • Clears the data in the print buffer and resets the printer modes to the modes that were in effect when the power was turned on.
 Keeps the following data:
 • Contents stored in the NV user memory
 • Contents defined for the NV bit image

ESC D n1...nk NUL

[Name] Set horizontal tab positions

[Format] ASCII ESC D n1...nk NUL
 Hex 1B 44 n1...nk 00
 Decimal 27 68 n1...nk 0

[Range] $1 \leq n1 \leq n2 \leq \dots \leq nk \leq 255$
 $0 \leq k \leq 32$

[Default] $n = 8, 16, 24, 32, 40, \dots, 232, 240, 248$ (for Font B in a standard character size width)

[Description] • Sets horizontal tab positions.
 • n specifies the number of digits from the setting position to the left edge of the printing area.
 • k is used to indicate the number of bytes set for the horizontal tab position.

EPSON	TITLE	SHEET REVISION	NO.	
	TM-U220 series Specification (STANDARD)	B	NEXT 90	SHEET 89

ESC E *n*

[Name]	Turn emphasized mode on/off			
[Format]	ASCII	ESC	E	<i>n</i>
	Hex	1B	45	<i>n</i>
	Decimal	27	69	<i>n</i>
[Range]	$0 \leq n \leq 255$			
[Default]	$n = 0$			
[Description]	<ul style="list-style-type: none"> • Turns emphasized mode on or off. <ul style="list-style-type: none"> • When the LSB of <i>n</i> is 0, emphasized mode is turned off. • When the LSB of <i>n</i> is 1, emphasized mode is turned on. 			
[Note]	<ul style="list-style-type: none"> • 2-pass printing is slower in emphasized mode. 			

ESC G *n*

[Name]	Turn double-strike mode on/off			
[Format]	ASCII	ESC	G	<i>n</i>
	Hex	1B	47	<i>n</i>
	Decimal	27	71	<i>n</i>
[Range]	$0 \leq n \leq 255$			
[Default]	$n = 0$			
[Description]	<ul style="list-style-type: none"> • Turns double-strike mode on or off. <ul style="list-style-type: none"> • When the LSB of <i>n</i> is 0, double-strike mode is turned off. • When the LSB of <i>n</i> is 1, double-strike mode is turned on. 			
[Note]	<ul style="list-style-type: none"> • 2-pass printing is slower in double-strike mode. 			

ESC J *n*

[Name]	Print and feed paper			
[Format]	ASCII	ESC	J	<i>n</i>
	Hex	1B	4A	<i>n</i>
	Decimal	27	74	<i>n</i>
[Range]	$0 \leq n \leq 255$			
[Description]	<ul style="list-style-type: none"> • Prints the data in the print buffer and feeds the paper [$n \times$ (vertical motion unit)]. 			

EPSON	TITLE TM-U220 series Specification (STANDARD)	SHEET REVISION B	NO.	
			NEXT 91	SHEET 90

ESC K *n*

- [Name] Print and reverse feed
- [Format] ASCII ESC K *n*
 Hex 1B 4B *n*
 Decimal 27 75 *n*
- [Range] $0 \leq n \leq 48$
- [Description] • Prints the data in the print buffer and feeds the paper [$n \times$ (vertical motion unit)] in the reverse direction.
 • If *n* is out of the specified range, the printer prints the data and does not feed the paper.
- [Notes] • This command must not be issued continuously more than two times.
 • Reverse direction paper feeding causes the following problems:
 • Paper feed pitch is incorrect.
 • Printer noise is louder than normal.
 • The paper may rub against the ribbon and become dirty.

ESC M *n*

- [Name] Select character font
- [Format] ASCII ESC M *n*
 Hex 1B 4D *n*
 Decimal 27 77 *n*
- [Range] $n = 0, 1, 48, 49$
- [Default] $n = 1$
- [Description] • Selects character font.
- | <i>n</i> | Function |
|----------|----------------------------|
| 0, 48 | Character font A selected. |
| 1, 49 | Character font B selected. |

EPSON	TITLE	SHEET REVISION	NO.	
	TM-U220 series Specification (STANDARD)	B	NEXT 92	SHEET 91

ESC R *n*

[Name] Select an international character set

[Format] ASCII ESC R *n*
 Hex 1B 52 *n*
 Decimal 27 82 *n*

[Range] $0 \leq n \leq 15$

[Default] $n = 0$ [Other than the following models]
 $n = 15$ [Simplified Chinese model (when GB18030 is selected)]

[Description] • Selects international character set.

<i>n</i>	Character set
0	U.S.A.
1	France
2	Germany
3	U.K.
4	Denmark I
5	Sweden
6	Italy
7	Spain I
8	Japan
9	Norway
10	Denmark II
11	Spain II
12	Latin America
13	Korea
14	Slovenia / Croatia
15	China

ESC U *n*

[Name] Turn unidirectional printing mode on/off

[Format] ASCII ESC U *n*
 Hex 1B 55 *n*
 Decimal 27 85 *n*

[Range] $0 \leq n \leq 255$

[Default] $n = 0$

[Description] • Turns unidirectional printing mode on or off.
 • When the LSB of *n* is 0, turns off unidirectional printing mode.
 • When the LSB of *n* is 1, turns on unidirectional printing mode.

EPSON	TITLE	SHEET REVISION	NO.	
	TM-U220 series Specification (STANDARD)	B	NEXT 93	SHEET 92

ESC a n

- [Name] Select justification
- [Format] ASCII ESC a n
 Hex 1B 61 n
 Decimal 27 97 n
- [Range] $0 \leq n \leq 2, 48 \leq n \leq 50$
- [Default] $n = 0$
- [Description] • In standard mode, aligns all the data in one line to the position.

<i>n</i>	Justification
0, 48	Left justification
1, 49	Centering
2, 50	Right justification

ESC c 3 n

- [Name] Select paper sensor(s) to output paper-end signals
- [Format] ASCII ESC c 3 n
 Hex 1B 63 33 n
 Decimal 27 99 51 n
- [Range] $0 \leq n \leq 255$
- [Default] $n = 15$
- [Description] • Selects the paper sensor(s) to output paper end signals when a paper end is detected.

(<i>n</i>) Bit	Off/On	Hex	Decimal	Function
0	Off	00	0	Roll paper near-end sensor disabled.
	On	01	1	Roll paper near-end sensor enabled.
1	Off	00	0	Roll paper near-end sensor disabled.
	On	02	2	Roll paper near-end sensor enabled.
2	Off	00	0	Roll paper end sensor disabled.
	On	04	4	Roll paper end sensor enabled.
3	Off	00	0	Roll paper end sensor disabled.
	On	08	8	Roll paper end sensor enabled.
4 ~ 7	Off	00	0	Reserved.

- [Note] • This command is enabled only with a parallel interface.

EPSON	TITLE	TM-U220 series Specification (STANDARD)	SHEET REVISION	NO.	
			B	NEXT 94	SHEET 93

ESC c 4 n

[Name] Select paper sensor(s) to stop printing

[Format] ASCII ESC c 4 n
 Hex 1B 63 34 n
 Decimal 27 99 52 n

[Range] $0 \leq n \leq 255$

[Default] $n = 0$

[Description] • Selects the paper sensor(s) to use to stop printing when a paper end is detected.

(n) Bit	Off/On	Hex	Decimal	Function
0	Off	00	0	Roll paper near-end sensor disabled.
	On	01	1	Roll paper near-end sensor enabled.
1	Off	00	0	Roll paper near-end sensor disabled.
	On	02	2	Roll paper near-end sensor enabled.
2 ~ 7	Off	00	0	Reserved.

[Note] • If the printer is not equipped with the roll paper near-end sensor as an option, the printer does not stop with this command even though the roll paper near-end sensor is enabled.

ESC c 5 n

[Name] Enable/disable panel buttons

[Format] ASCII ESC c 5 n
 Hex 1B 63 35 n
 Decimal 27 99 53 n

[Range] $0 \leq n \leq 255$

[Default] $n = 0$

[Description] • Enables or disables the panel buttons.
 • When the LSB of n is 0, the panel buttons are enabled.
 • When the LSB of n is 1, the panel buttons are disabled.

[Notes] • When the paper near-end detects the paper end, the paper FEED button is always ignored regardless of the setting with this command.

EPSON	TITLE	SHEET REVISION	NO.	
	TM-U220 series Specification (STANDARD)	B	NEXT 95	SHEET 94

ESC d n

[Name] Print and feed n lines

[Format] ASCII ESC d n
Hex 1B 64 n
Decimal 27 100 n

[Range] $0 \leq n \leq 255$

[Description] • Prints the data in the print buffer and feeds the paper [$n \times$ (current line spacing)].

ESC e n

[Name] Print and reverse feed n lines

[Format] ASCII ESC e n
Hex 1B 65 n
Decimal 27 101 n

[Range] $0 \leq n \leq 2$

[Description] • Prints the data in the print buffer and feeds the paper [$n \times$ (current line spacing)] in the reverse direction.
• If n is out of the specified range, the printer prints the data and does not feed the paper.

[Notes] • This command must not be issued continuously more than two times.
• Reverse direction paper feeding causes the following problems:
• Paper feed pitch is incorrect.
• Printer noise is louder than normal.
• The paper may rub against the ribbon and become dirty.

EPSON	TITLE TM-U220 series Specification (STANDARD)	SHEET REVISION B	NO.	
			NEXT 96	SHEET 95

ESC p m t1 t2

[Name] Generate pulse

[Format] ASCII ESC p m t1 t2
 Hex 1B 70 m t1 t2
 Decimal 27 112 m t1 t2

[Range] m = 0, 1, 48, 49
 0 ≤ t1 ≤ 255
 0 ≤ t2 ≤ 255

[Description] • Outputs the pulse specified by t1 and t2 to connector pin m.

m	Connector pin
0, 48	Drawer kick out connector pin 2.
1, 49	Drawer kick out connector pin 5.

- t1 specifies the pulse on time as (t1 × 2 ms).
- t2 specifies the pulse off time as (t2 × 2 ms).
 If t2 is less than 50, t2 is assumed to be equal to 50.

[Note] • Specify a value so that the off time is longer than the on time (t1 < t2).

ESC r n

[Name] Select print color

[Format] ASCII ESC r n
 Hex 1B 72 n
 Decimal 27 114 n

[Range] n = 0, 1, 48, 49

[Default] n = 0

[Description] • Selects print color.

n	Print color
0, 48	Black
1, 49	Red

[Note] • This command is valid only in the two-color print model.

[Reference] Appendix A

EPSON	TITLE	SHEET REVISION	NO.	
	TM-U220 series Specification (STANDARD)	B	NEXT 97	SHEET 96

ESC t n

- [Name] Select character code table
- [Format] ASCII ESC t n
 Hex 1B 74 n
 Decimal 27 116 n
- [Range] $0 \leq n \leq 5, 16 \leq n \leq 19, n = 254, 255$ [Other than the following models]
 $0 \leq n \leq 8, 16 \leq n \leq 19, n = 254, 255$ [Japanese model]
 $0 \leq n \leq 5, 16 \leq n \leq 26, n = 254, 255$ [Thai model]
- [Default] $n = 0$ [Other than the following models]
 $n = 20$ [Thai model]
- [Description] • Selects a page n from the character code table.

n	Character code table
0	Page 0 [PC437 (USA: Standard Europe)]
1	Page 1 [Katakana]
2	Page 2 [PC850 (Multilingual)]
3	Page 3 [PC860 (Portuguese)]
4	Page 4 [PC863 (Canadian-French)]
5	Page 5 [PC865 (Nordic)]
6	Page 6 [Hiragana]
7	Page 7 [One-pass printing Kanji characters]
8	Page 8 [One-pass printing Kanji characters]
16	Page 16 [WPC1252]
17	Page 17 [PC866 (Cyrillic #2)]
18	Page 18 [PC852 (Latin 2)]
19	Page 19 [PC858 (Euro)]
20	Page 20 [Thai character code 42]
21	Page 21 [Thai character code 11]
22	Page 22 [Thai character code 13]
23	Page 23 [Thai character code 14]
24	Page 24 [Thai character code 16]
25	Page 25 [Thai character code 17]
26	Page 26 [Thai character code 18]
255	Page 255 [User-defined page]

ESC { n

[Name] Turn upside-down printing mode on/off

[Format] ASCII ESC { n
 Hex 1B 7B n
 Decimal 27 123 n

[Range] $0 \leq n \leq 255$

[Default] $n = 0$

[Description] • In standard mode, turns upside-down printing mode on or off.
 • When the LSB of n is 0, upside-down printing mode is turned off.
 • When the LSB of n is 1, upside-down printing mode is turned on.

FS p n m

[Name] Print NV bit image

[Format] ASCII FS p n m
 Hex 1C 70 n m
 Decimal 28 112 n m

[Range] $1 \leq n \leq 255$
 $m = 0, 1, 48, 49$

[Description] • Prints NV bit image n by the process of **FS q** using the mode specified by n .

m	Mode	Enlargement in vertical direction	Enlargement in horizontal direction
0, 48	Normal	1	1
1, 49	Double-width	1	2

EPSON	TITLE TM-U220 series Specification (STANDARD)	SHEET REVISION B	NO.	
			NEXT 99	SHEET 98

FS q n [xL xH yL yH d1...dk]1 ... [xL xH yL yH d1...dk]n

[Name]	Define NV bit image
[Format]	ASCII FS q n [xL xH yL yH d1...dk]1...[xL xH yL yH d1...dk]n Hex 1C 71 n [xL xH yL yH d1...dk]1...[xL xH yL yH d1...dk]n Decimal 28 113 n [xL xH yL yH d1...dk]1...[xL xH yL yH d1...dk]n
[Range]	$1 \leq n \leq 255$ $1 \leq (xL + xH \times 256) \leq 1023$ ($0 \leq xL \leq 255, 0 \leq xH \leq 3$) $1 \leq (yL + yH \times 256) \leq 288$ ($0 \leq yL \leq 255, yH = 0,1$) $0 \leq d \leq 255$ $k = (xL + xH \times 256) \times (yL + yH \times 256) \times 8$ The entire capacity size = 128KB.
[Description]	<ul style="list-style-type: none"> • Defines the NV bit image in the NV graphics area. • n specifies the number of defined NV bit images. • xL, xH specify the horizontal size as (xL + xH × 256) bytes. • yL, yH specify the vertical size as (yL + yH × 256) bytes. • d specifies the defined data (column format).
[Notes]	<ul style="list-style-type: none"> • Frequent write command executions by an NV memory write command may damage the NV memory. Therefore, it is recommended to write to the NV memory no more than 10 times a day. • While processing this command, the printer is BUSY while writing data to the NV memory and stops receiving data. Therefore be sure not to transmit data including the real-time commands during the execution of this command.

EPSON	TITLE	SHEET REVISION	NO.	
	TM-U220 series Specification (STANDARD)	B	NEXT 100	SHEET 99

GS (A p_L p_H n m)

[Name] Execute test print

[Format] ASCII GS (A p_L p_H n m
 Hex 1D 28 41 p_L p_H n m
 Decimal 29 40 65 p_L p_H n m

[Range] $(p_L + p_H \times 256) = 2$ ($p_L = 2, p_H = 0$)
 $0 \leq n \leq 2, 48 \leq n \leq 50$
 $1 \leq m \leq 3, 49 \leq m \leq 51$

- [Description]
- Executes a specified test print.
 - p_L, p_H specify $(p_L + p_H \times 256)$ the number of bytes after p_H (n and m).
 - n specifies paper used for the test print.

n	Paper source
0, 48	Basic sheet (roll paper)
1, 49	Roll paper
2, 50	

- m specifies a test pattern.

m	Test pattern
1, 49	Hexadecimal dump
2, 50	Printer status print
3, 51	Rolling pattern print

- [Notes]
- The printer executes a software reset after processing this command.
 - Clears the receive and print buffers.
 - Resets all settings value in the RAM (the printing area, the print styles, user-defined characters, and others) that was in effect at power on. (The data in the NV-memory are not reset.)

EPSON	TITLE	TM-U220 series Specification (STANDARD)	SHEET REVISION	NO.	
			B	NEXT 101	SHEET 100

GS (C pL pH m fn b [c1 c2] [d1...dk]

[Name] Edit NV user memory

- [Description]
- Edits data in the NV user memory. .
 - *pL*, *pH* specify ($pL + pH \times 256$) the number of bytes after *pH* (*m*, *fn*, *b*, [*c1 c2*], and [*d1...dk*]).
 - *fn* specifies the function.
 - *c1*, *c2* specify the key code (which identifies the record).
 - [*d1...dk*] specify the process of each function.

<i>fn</i>	Format	Function No.	Function
0, 48	GS (C pL pH m fn b c1 c2	0	Deletes the specified record.
1, 49	GS (C pL pH m fn b c1 c2 d1...dk	1	Stores data in the specified record.
2, 50	GS (C pL pH m fn b c1 c2	2	Transmits the data in the specified record.
3, 51	GS (C pL pH m fn b	3	Transmits the number of bytes of memory used.
4, 52	GS (C pL pH m fn b	4	Transmits the number of bytes of remaining memory (unused area).
5, 53	GS (C pL pH m fn b	5	Transmits the key code list.
6, 54	GS (C pL pH m fn b d1 d2 d3	6	Deletes all data in the NV user memory.

[Notes]

- Frequent write command executions by an NV memory write command may damage the NV memory. Therefore, it is recommended to write to the NV memory not more than 10 times a day.
- While processing this command, the printer is BUSY while writing data to the NV memory and stops receiving data. Therefore, be sure not to transmit data including the real-time commands during the execution of this command.
- When <Function 2, 3, 4, or 5> is transmitted, the following data must not be transmitted until the status is received. And it will be necessary to perform the ESC/POS handshaking protocol procedures when using <Function 2 and 5>.

EPSON	TITLE TM-U220 series Specification (STANDARD)	SHEET REVISION B	NO.	
			NEXT 102	SHEET 101

<Function 0> **GS (C pL pH m fn b c1 c2 (fn = 0, 48)**

[Format]	ASCII	GS	(C	pL	pH	m	fn	b	c1	c2
	Hex	1D	28	43	pL	pH	m	fn	b	c1	c2
	Decimal	29	40	67	pL	pH	m	fn	b	c1	c2

[Range] $(pL + pH \times 256) = 5$ ($pL = 5, pH = 0$)
 $m = 0$
 $fn = 0, 48$
 $b = 0$
 $32 \leq c1 \leq 126$
 $32 \leq c2 \leq 126$

[Description] • Deletes the record specified by the key codes (c1, c2) in the NV user memory.

<Function 1> **GS (C pL pH m fn b c1 c2 d1...dk (fn = 1, 49)**

[Format]	ASCII	GS	(C	pL	pH	m	fn	b	c1	c2	d1...dk
	Hex	1D	28	43	pL	pH	m	fn	b	c1	c2	d1...dk
	Decimal	29	40	67	pL	pH	m	fn	b	c1	c2	d1...dk

[Range] $6 \leq (pL + pH \times 256) \leq 65535$ ($0 \leq pL \leq 255, 0 \leq pH \leq 255$)
 $m = 0$
 $fn = 1, 49$
 $b = 0$
 $32 \leq c1 \leq 126$
 $32 \leq c2 \leq 126$
 $32 \leq d \leq 254$
 $k = (pL + pH \times 256) - 5$
 The entire capacity size = 8KB.

[Description] • Stores the data (d1...dk) as the record specified by the key codes (c1, c2) in the NV user memory.
 • [d1...dk] specify the stored data (contents of the record).

[Note] • If the number of data $((pL + pH \times 256) - 5)$ exceeds the remaining capacity of the NV user memory, this function does not work.

EPSON	TITLE	TM-U220 series Specification (STANDARD)	SHEET REVISION	NO.	
			B	NEXT 103	SHEET 102

<Function 2> **GS (C ρ_L ρ_H m fn b c1 c2** (fn = 2, 50)

[Format]	ASCII	GS	(C	ρ_L	ρ_H	m	fn	b	c1	c2
	Hex	1D	28	43	ρ_L	ρ_H	m	fn	b	c1	c2
	Decimal	29	40	67	ρ_L	ρ_H	m	fn	b	c1	c2

[Range] $(\rho_L + \rho_H \times 256) = 5$ ($\rho_L = 5, \rho_H = 0$)
 $m = 0$
 $fn = 2, 50$
 $b = 0$
 $32 \leq c1 \leq 126$
 $32 \leq c2 \leq 126$

[Description] • Transmits data for the record specified by the key codes (c1, c2) in the NV user memory.

<Function 3> **GS (C ρ_L ρ_H m fn b** (fn = 3, 51)

[Format]	ASCII	GS	(C	ρ_L	ρ_H	m	fn	b
	Hex	1D	28	43	ρ_L	ρ_H	m	fn	b
	Decimal	29	40	67	ρ_L	ρ_H	m	fn	b

[Range] $(\rho_L + \rho_H \times 256) = 3$ ($\rho_L = 3, \rho_H = 0$)
 $m = 0$
 $fn = 3, 51$
 $b = 0$

[Description] • Transmits the number of bytes of memory used in the NV user memory.

<Function 4> **GS (C ρ_L ρ_H m fn b** (fn = 4, 52)

[Format]	ASCII	GS	(C	ρ_L	ρ_H	m	fn	b
	Hex	1D	28	43	ρ_L	ρ_H	m	fn	b
	Decimal	29	40	67	ρ_L	ρ_H	m	fn	b

[Range] $(\rho_L + \rho_H \times 256) = 3$ ($\rho_L = 3, \rho_H = 0$)
 $m = 0$
 $fn = 4, 52$
 $b = 0$

[Description] • Transmits the number of bytes of remaining memory (unused area) in the NV user memory.

EPSON	TITLE	TM-U220 series Specification (STANDARD)	SHEET REVISION	NO.	
			B	NEXT 104	SHEET 103

<Function 5> **GS (C pL pH m fn b** (fn = 5, 53)

[Format]	ASCII	GS	(C	pL	pH	m	fn	b
	Hex	1D	28	43	pL	pH	m	fn	b
	Decimal	29	40	67	pL	pH	m	fn	b

[Range] (pL + pH × 256) = 3 (pL = 3, pH = 0)
 m = 0
 fn = 5, 53
 b = 0

[Description] • Transmits the key code list in the NV user memory.

<Function 6> **GS (C pL pH m fn b d1 d2 d3** (fn = 6, 54)

[Range]	ASCII	GS	(C	pL	pH	m	fn	b	d1	d2	d3
	Hex	1D	28	43	pL	pH	m	fn	b	d1	d2	d3
	Decimal	29	40	67	pL	pH	m	fn	b	d1	d2	d3

[Range] (pL + pH × 256) = 6 (pL = 6, pH = 0)
 m = 0
 fn = 6, 54
 b = 0
 d1 = 67
 d2 = 76
 d3 = 82

[Description] • Deletes all data in the NV user memory.

EPSON	TITLE	TM-U220 series Specification (STANDARD)	SHEET REVISION	NO.	
			B	NEXT 105	SHEET 104

GS (D pL pH m [$a1$ $b1$]...[ak bk]

[Name] Enable/disable real-time command

[Format] ASCII GS (D pL pH m [$a1$ $b1$]...[ak bk]
 Hex 1D 28 44 pL pH m [$a1$ $b1$]...[ak bk]
 Decimal 29 40 68 pL pH m [$a1$ $b1$]...[ak bk]

[Range] ($pL + pH \times 256$) = 3, 5 ($pL = 3,5, pH = 0$)
 $m = 20$
 $a = 1$
 $b = 0, 1, 48, 49$

[Default]

a	Type(s) of real-time commands	Default
1	DLE DC4 fn m t ($fn = 1$): Generate pulse in real-time	Enabled ($b = 1$)

[Description]

- Enables or disables the following real-time commands.
 - pL, pH specify ($pL + pH \times 256$) as the number of bytes after pH (m and [$a1$ $b1$]...[ak bk]).
 - a specifies the type of real-time command.
 - b specifies enable or disable of real-time command processing.

a	b	Function
1	0, 48	DLE DC4 fn m t ($fn = 1$): Not processed (disabled)
	1, 49	DLE DC4 fn m t ($fn = 1$): Processed (enabled)

[Note]

- If bit image data accidentally includes a character string with this command, it is recommended to use this command in advance to disable the real-time commands.

EPSON	TITLE	SHEET REVISION	NO.	
	TM-U220 series Specification (STANDARD)		B	NEXT 106

GS (E pL pH fn [parameters]

[Name] Set user setup commands

- [Description]
- Controls the user setting modes.
 - pL, pH specify (pL + pH × 256) as the number of bytes after pH (fn and [parameters]).
 - fn specifies the function.
 - [parameters] specify the process of each function.

<i>fn</i>	Format	Function No.	Function
1	GS (E pL pH fn d1 d2	1	Changes into the user setting mode.
2	GS (E pL pH fn d1 d2 d3	2	Ends the user setting mode session. (Performs a soft reset.)
3	GS (E pL pH fn [a1 b18...b11] ... [ak bk8....bk1]	3	Changes the memory switch.
4	GS (E pL pH fn a	4	Transmits the settings of the memory switch.
5	GS (E pL pH fn [a1 n1L n1H] ... [ak nkL nkH]	5	Sets the customized setting values.
6	GS (E pL pH fn a	6	Transmits the customized setting values.
11	GS (E pL pH fn a d1...dk	11	Sets the communication conditions for the serial interface.
12	GS (E pL pH fn a	12	Transmits the communication conditions for the serial interface.

- [Notes]
- Frequent write command executions by an NV memory write command may damage the NV memory. Therefore, it is recommended to write to NV memory not more than ten times a day.
 - While processing this command, the printer is BUSY while writing data to the NV memory and stops receiving data. Therefore, be sure not to transmit data, including the real-time commands, during the execution of this command.
 - When <Function 1, 4, 6, and 12> is transmitted, the following data must not be transmitted until the status is received.

EPSON	TITLE	SHEET REVISION	NO.	
	TM-U220 series Specification (STANDARD)	B	NEXT 107	SHEET 106

<Function 1> **GS (E pL pH fn d1 d2 (fn = 1)**

[Format]	ASCII	GS	(E	pL	pH	fn	d1	d2
	Hex	1D	28	45	pL	pH	fn	d1	d2
	Decimal	29	40	69	pL	pH	fn	d1	d2

[Range] $(pL + pH \times 256) = 3$ ($pL = 3, pH = 0$)
 $fn = 1$
 $d1 = 73$
 $d2 = 78$

[Description] • Enters the user setting mode and transmits data that notice the mode has changed.

<Function 2> **GS (E pL pH fn d1 d2 d3 (fn = 2)**

[Format]	ASCII	GS	(E	pL	pH	fn	d1	d2	d3
	Hex	1D	28	45	pL	pH	fn	d1	d2	d3
	Decimal	29	40	69	pL	pH	fn	d1	d2	d3

[Range] $(pL + pH \times 256) = 4$ ($pL = 4, pH = 0$)
 $fn = 2$
 $d1 = 79$
 $d2 = 85$
 $d3 = 84$

[Description] • Ends the user setting mode and performs a software reset.
 • Clears the receive and print buffers.
 • Resets all settings value in the RAM (the printing area, the print styles, user-defined characters, and others) that was in effect at power on. (The data in the NV-memory are not reset.)

EPSON	TITLE TM-U220 series Specification (STANDARD)	SHEET REVISION B	NO.	
			NEXT 108	SHEET 107

<Function 3> **GS (E pL pH fn [a1 b18...b11]...[ak bk8...bk1] (fn = 3)**

[Format]	ASCII	GS	(E	pL	pH	fn	[a1	b18 ...	b11]	...	[ak	bk8 ...	bk1]
	Hex	1D	28	45	pL	pH	fn	[a1	b18 ...	b11]	...	[ak	bk8 ...	bk1]
	Decimal	29	40	69	pL	pH	fn	[a1	b18 ...	b11]	...	[ak	bk8 ...	bk1]

[Range] $10 \leq (pL + pH \times 256) \leq 65530$ ($0 \leq pL \leq 255, 0 \leq pH \leq 255$)
 $fn = 3$
 $a = 2, 8$
 $b = 48, 49, 50$

[Default (upon shipment)]
 All switches are set to Off ($b=48$).

- [Description]
- Changes the memory switch specified by a to the values specified with b .
 - When ($b = 48$), the applicable bit is turned Off.
 - When ($b = 49$), the applicable bit is turned On.
 - When ($b = 50$), the applicable bit is not changed. Set ($b = 50$) as the reserved bit.
 - Memory switch 2 (Msw 2: $a = 2$)

Msw	Function	Setting value
2-1,2-2	Reserved.	50
2-3	Character code system for the simplified Chinese model: GB18030	48
	Character code system for the simplified Chinese model: GB2312	49
2-4 ~ 2-8	Reserved.	50

- Memory switch 8 (Msw 8: $a = 8$)

Msw	Function	Setting value
8-1 ~ 8-4	Reserved.	50
8-5	The printer status is sent back as the paper empty when the cover is opened.	48
	The cover open status is selected.	49
8-6	Reserved.(Fixed to off.)	48
8-7	Printer BUSY is released when the remaining capacity of the receive buffer goes to 256 bytes.	48
	Printer BUSY is released when the remaining capacity of the receive buffer goes to 138 bytes.	49
8-8	Printer cover open during operation: Error that automatically recovers.	48
	Printer cover open during operation: Error that can possibly recover.	49

EPSON	TITLE	TM-U220 series Specification (STANDARD)	SHEET REVISION	NO.	
			B	NEXT 109	SHEET 108

<Function 4> **GS (E pL pH fn a (fn = 4)**

[Format]	ASCII	GS	(E	pL	pH	fn	a
	Hex	1D	28	45	pL	pH	fn	a
	Decimal	29	40	69	pL	pH	fn	a

[Range] $(pL + pH \times 256) = 2$ ($pL = 2, pH = 0$)
 $fn = 4$
 $a = 2, 8$

[Description] • Transmits the setting value(s) of the memory switch specified by a.

<Function 5> **GS (E pL pH fn [a1 n1L n1H]...[ak nkL nkH] (fn = 5)**

[Format]	ASCII	GS	(E	pL	pH	fn	[a1	n1L	n1H]	...	[ak	nkL	nkH]
	Hex	1D	28	45	pL	pH	fn	[a1	n1L	n1H]	...	[ak	nkL	nkH]
	Decimal	29	40	69	pL	pH	fn	[a1	n1L	n1H]	...	[ak	nkL	nkH]

[Range] $4 \leq (pL + pH \times 256) \leq 65533$ ($0 \leq pL \leq 255, 0 \leq pH \leq 255$)
 $fn = 5$
 $a = 3$

$(nL + nH \times 256) = 2, 4, 5$ ($nL = 2,4,5, nH = 0$)

[Default] $(nL + nH \times 256) = 5$ ($nL = 5, nH = 0$) [when (a=3)]

[Description] • Sets the customized value specified by a according to the value $(nL + nH \times 256)$.

a	Customized value
3	Width of roll paper

• Width of roll paper setting (a = 3)

Value of $(nL + nH \times 256)$	Paper Width
2	57.5 mm {2.26"}
4	69.5 mm {2.74"}
5	76 mm {2.99"}

EPSON	TITLE	SHEET REVISION	NO.	
	TM-U220 series Specification (STANDARD)	B	NEXT 110	SHEET 109

<Function 6> **GS (E ρ_L ρ_H fn a)** ($fn = 6$)

[Format] ASCII GS (E ρ_L ρ_H fn a
 Hex 1D 28 45 ρ_L ρ_H fn a
 Decimal 29 40 69 ρ_L ρ_H fn a

[Range] ($\rho_L + \rho_H \times 256$) = 2 ($\rho_L = 2, \rho_H = 0$)
 $fn = 6$
 $a = 3$

[Description] • Transmits the customized value specified by a .

a	Customized value
3	Width of roll paper

<Function 11> **GS (E ρ_L ρ_H fn a $d1...dk$)** ($fn = 11$)

[Format] ASCII GS (E ρ_L ρ_H fn a $d1 \dots dk$
 Hex 1D 28 45 ρ_L ρ_H fn a $d1 \dots dk$
 Decimal 29 40 69 ρ_L ρ_H fn a $d1 \dots dk$

[Range] $3 \leq (\rho_L + \rho_H \times 256) \leq 8$ ($3 \leq \rho_L \leq 8, \rho_H = 0$)
 $fn = 11$
 $1 \leq a \leq 4$
 $48 \leq d \leq 57$

[Default (upon shipment)]

9600 bps, no parity, DTR/DSR control, 8 bits
 $d1...dk = "9600"$ [when ($a = 1$)]
 $d1 = 48$ [when ($a = 2$)]
 $d1 = 48$ [when ($a = 3$)]
 $d1 = 56$ [when ($a = 4$)]

[Description] • Sets the communication conditions for the serial interface specified by a according to value d .

a	Communication Condition	Specification of d
1	Transmission speed	k bytes of ($d1...dk$)
2	Parity	1 byte of ($d1$)
3	Flow control	1 byte of ($d1$)
4	Data length	1 byte of ($d1$)

• Transmission speed setting ($a = 1$)

Transmission speed (bps)	$d1$	$d2$	$d3$	$d4$	$d5$
1200	49	50	48	48	--
2400	50	52	48	48	--
4800	52	56	48	48	--
9600	57	54	48	48	--
19200	49	57	50	48	48

• Parity setting ($a = 2$)

<i>d1</i>	Parity
48	No parity
49	Odd parity
50	Even parity

• Flow control setting ($a = 3$)

<i>d1</i>	Flow control
48	DTR/DSR
49	XON/XOFF

• Data length setting ($a = 4$)

<i>d1</i>	Data length
55	7 bits
56	8 bits

[Note]

- The communication condition set by this function is enabled by executing <Function 2> or restarting the printer. Note that the host must be set to enable the printer to communicate with the host.

<Function 12> **GS (E ρ_L ρ_H fn a ($fn = 12$)**

[Format]	ASCII	GS	(E	ρ_L	ρ_H	fn	a
	Hex	1D	28	45	ρ_L	ρ_H	fn	a
	Decimal	29	40	69	ρ_L	ρ_H	fn	a

[Range] $(\rho_L + \rho_H \times 256) = 2$ ($\rho_L = 2, \rho_H = 0$)
 $fn = 12$
 $1 \leq a \leq 4$

[Description] • Transmits the communication conditions of the serial interface specified by a .

a	Communication conditions
1	Transmission speed
2	Parity
3	Flow control
4	Data length

EPSON	TITLE TM-U220 series Specification (STANDARD)	SHEET REVISION B	NO.	
			NEXT 112	SHEET 111

GS I n

- [Name] Transmit printer ID
- [Format] ASCII GS I n
 Hex 1D 49 n
 Decimal 29 73 n
- [Range] $1 \leq n \leq 3, 49 \leq n \leq 51, 65 \leq n \leq 69, n = 33$
- [Description] • Transmits the printer ID specified.

n	Printer ID type	ID
1, 49	Printer model ID	Hexadecimal: 0DH / Decimal: 13
2, 50	Type ID	See table [Type ID].
3, 51	Firmware version ID	Depends on firmware version.

[Type ID]

Bit	Off/On	Hex	Decimal	Contents
0	Off	00	0	Multi byte code characters not supported.
	On	01	1	Multi byte code characters supported.
1	Off	00	0	Autocutter not installed. (Dip switch [SW 2-2] is set to Off.)
	On	02	2	Autocutter installed. (Dip switch [SW 2-2] is set to On.)
2,3	--	--	--	Reserved.
4	Off	00	0	Fixed.
5,6	--	--	--	Reserved.
7	Off	00	0	Fixed.

- Transmits the printer information specified.

n	Type of printer information	Contents
33	Type information	See table [Type information].
65	Firmware version	Depends on firmware version.
66	Manufacturer	"EPSON"
67	Printer name	"TM-U220"
68	Product ID	Serial number.
69	Type of mounted additional fonts	Japanese model : KANJI JAPANESE
		Simplified Chinese model : CHINA GB18030 or CHINA GB2312
		Traditional Chinese model : TAIWAN BIG-5
		Korean model : KOREA C-5601C
		Thai mode : THAI 3 PASS

EPSON	TITLE TM-U220 series Specification (STANDARD)	SHEET REVISION B	NO.	
			NEXT 113	SHEET 112

[Type information]

Bit	Off/On	Hex	Decimal	Contents
0	Off	00	0	Multi byte code characters not supported.
	On	01	1	Multi byte code characters supported.
1	Off	00	0	Autocutter not installed. (Dip switch [SW 2-2] is set to Off.)
	On	02	2	Autocutter installed. (Dip switch [SW 2-2] is set to On.)
2 ~ 5	--	--	--	Reserved.
6	On	40	64	Fixed.
7	Off	00	0	Fixed.

[Note]

- When this command is transmitted, the following printer ID or printer information must not be transmitted until the status is received.

<A> GS V m

** GS V m n**

[Name] Select cut mode and cut paper

[Format]

<A>	ASCII	GS	V	<i>m</i>
	Hex	1D	56	<i>m</i>
	Decimal	29	86	<i>m</i>
	ASCII	GS	V	<i>m n</i>
	Hex	1D	56	<i>m n</i>
	Decimal	29	86	<i>m n</i>

[Range]

<A> *m* = 0, 1, 48, 49
**** *m* = 65, 66, 0 ≤ *n* ≤ 255

[Description] • Cuts paper in the specified mode.

	<i>m</i>	Function
<A>	0, 48 1, 49	Cuts paper
	65, 66	Feeds paper to (cut position + [<i>n</i> × (vertical motion unit)]) and cuts the paper.

[Notes]

- Type of cutting is set with the installation position of the autocutter.
 - Partial cut (one point left uncut)
 - Full cut
- The cutting position differs depending on each model.
 - Type A and B: Position at the autocutter
 - Type D: Position at the manual cutter

EPSON	TITLE	SHEET REVISION	NO.	
	TM-U220 series Specification (STANDARD)	B	NEXT 114	SHEET 113

GS a n

[Name] Enable/disable Automatic Status Back (ASB)

[Format] ASCII GS a n
 Hex 1D 61 n
 Decimal 29 97 n

[Range] $0 \leq n \leq 255$

[Default] $n = 0$ (when Dip switch [SW 1-8] is off.)
 $n = 2$ (when Dip switch [SW 1-8] is on.)

[Description] • Enables or disables basic ASB (Automatic Status Back).

(n) Bit	Off/On	Hex	Decimal	Function
0	Off	00	0	Drawer kick out connector pin 3 disabled.
	On	01	1	Drawer kick out connector pin 3 enabled.
1	Off	00	0	Online/offline status disabled.
	On	02	2	Online/offline status enabled.
2	Off	00	0	Error status disabled.
	On	04	4	Error status enabled.
3	Off	00	0	Roll paper sensor status disabled.
	On	08	8	Roll paper sensor status enabled.
4 ~ 7	Off	00	0	Reserved.

• After the first status transmission , the selected enabled basic ASB status is transmitted whenever the status changes as long as the basic ASB is active.

- The basic ASB status to be transmitted is contained in the four bytes that follow:
- First byte (printer information)

Bit	Off/On	Hex	Decimal	Status
0, 1	Off	00	0	Fixed.
2	Off	00	0	Drawer kick out connector pin 3 is LOW.
	On	04	4	Drawer kick out connector pin 3 is HIGH.
3	Off	00	0	Online.
	On	08	8	Offline.
4	On	10	16	Fixed.
5	Off	00	0	The roll paper cover is closed.
	On	20	32	The roll paper cover is opened.
6	Off	00	0	Paper is not being fed by using the paper FEED button.
	On	40	64	Paper is being fed by using the paper FEED button.
7	Off	00	0	Fixed.

EPSON	TITLE	TM-U220 series Specification (STANDARD)	SHEET REVISION	NO.	
			B	NEXT 115	SHEET 114

• Second byte (printer information)

Bit	Off/On	Hex	Decimal	Status
0, 1	--	--	--	Reserved.
2	Off	00	0	No mechanical error.
	On	04	4	Mechanical error.
3	Off	00	0	No autocutter error.
	On	08	8	Autocutter error.
4	Off	00	0	Fixed.
5	Off	00	0	No unrecoverable error.
	On	20	32	Unrecoverable error.
6	Off	00	0	No automatically recoverable error.
	On	40	64	Automatically recoverable error.
7	Off	00	0	Fixed.

• Third byte (paper sensor information)

Bit	Off/On	Hex	Decimal	Status
0, 1	Off	00	0	Roll paper near-end sensor: paper adequate.
	On	03	3	Roll paper near-end sensor: paper near end.
2, 3	Off	00	0	Roll paper end sensor: paper present.
	On	0C	12	Roll paper end sensor: paper not present.
4	Off	00	0	Fixed.
5, 6	--	--	--	Reserved.
7	Off	00	0	Fixed.

Bits 0 and 1: The roll paper near-end sensor is an option: on units that do not have this option, bits 0 and 1 are "0" (paper adequate).

• Fourth byte (paper sensor information)

Bit	Off/On	Hex	Decimal	Status
0 ~ 3	--	--	--	Reserved.
4	Off	00	0	Fixed.
5, 6	--	--	--	Reserved.
7	Off	00	0	Fixed.

EPSON	TITLE TM-U220 series Specification (STANDARD)	SHEET REVISION B	NO.	
			NEXT 116	SHEET 115

GS r n

[Name] Transmit status
 [Format] ASCII GS r n
 Hex 1D 72 n
 Decimal 29 114 n
 [Range] n = 1, 2, 49, 50
 [Description] • Transmits the status.

n	Function
1, 49	Transmits paper sensor status.
2, 50	Transmits drawer kick out connector status.

- This printer transmits the following status.
- Paper sensor status (n = 1, 49)

Bit	Off/On	Hex	Decimal	Status
0, 1	Off	00	0	Roll paper near-end sensor: paper adequate.
	On	03	3	Roll paper near-end sensor: paper near end.
2, 3	Off	00	0	Roll paper end sensor: paper present.
	On	0C	12	Roll paper end sensor: paper not present.
4	Off	00	0	Fixed.
5, 6	--	--	--	Reserved.
7	Off	00	0	Fixed.

Bits 0 and 1: The roll paper near-end sensor is an option: on units that do not have this option, bits 0 and 1 are "0" (paper adequate).

- Drawer kick out connector status (n = 2, 50)

Bit	Off/On	Hex	Decimal	Status
0	Off	00	0	Drawer kick out connector pin 3 is LOW.
	On	01	1	Drawer kick out connector pin 3 is HIGH.
1 ~ 3	--	--	--	Reserved.
4	Off	00	0	Fixed.
5, 6	--	--	--	Reserved.
7	Off	00	0	Fixed.

[Note] • When this command is transmitted, the following status must not be transmitted until this status is received.

EPSON	TITLE	SHEET REVISION	NO.	
	TM-U220 series Specification (STANDARD)	B	NEXT 117	SHEET 116

6.4 Multi-byte code characters commands list

(for Japanese model, Simplified Chinese model, Traditional Chinese model, and Korean model)

FS ! *n*

[Name] Select print mode(s) for Kanji characters

[Format] ASCII FS ! *n*
 Hex 1C 21 *n*
 Decimal 28 33 *n*

[Range] $0 \leq n \leq 255$

[Default] $n = 0$

[Description] • Selects the character styles (double-height, double-width, and Kanji-underlined) for multi-byte code characters together.

(<i>n</i>) Bit	Off/On	Hex	Decimal	Function
0, 1	Off	00	0	Reserved.
2	Off	00	0	Double-width mode not selected.
	On	04	4	Double-width mode selected.
3	Off	00	0	Double-height mode not selected.
	On	08	8	Double-height mode selected.
4 ~ 6	Off	00	0	Reserved.
7	Off	00	0	Kanji-underline mode not selected.
	On	80	128	Kanji-underline mode selected.

FS &

[Name] Select Kanji character mode

[Format] ASCII FS &
 Hex 1C 26
 Decimal 28 38

[Description] • Selects Kanji character mode.

EPSON	TITLE TM-U220 series Specification (STANDARD)	SHEET REVISION B	NO.	
			NEXT 118	SHEET 117

FS – n

[Name] Turn underline mode on/off for Kanji characters

[Format] ASCII FS – n
 Hex 1C 2D n
 Decimal 28 45 n

[Range] n = 0, 1, 48, 49

[Default] n = 0

[Description] • Turns Kanji-underline mode on or off.

n	Function
0, 48	Turns off Kanji-underline mode
1, 49	Turns on Kanji-underline mode

FS .

[Name] Cancel Kanji character mode

[Format] ASCII FS .
 Hex 1C 2E
 Decimal 28 46

[Description] • Cancels Kanji character mode.

EPSON	TITLE TM-U220 series Specification (STANDARD)	SHEET REVISION B	NO.	
			NEXT 119	SHEET 118

FS 2 c1 c2 [d1...dk]

[Name] Define user-defined Kanji characters

[Format] ASCII FS 2 c1 c2 [d1...dk]
 Hex 1C 32 c1 c2 [d1...dk]
 Decimal 28 50 c1 c2 [d1...dk]

[Range] The ranges of c1 and c2 differ, depending on specifications and the character code system used.

Model	c1	c2
Japanese (JIS code)	c1 = 77H	21H ≤ c2 ≤ 7EH
Japanese (SHIFT JIS code)	c1 = ECH	40H ≤ c2 ≤ 7EH 80H ≤ c2 ≤ 9EH
Simplified Chinese (GB18030 and GB2312) Traditional Chinese Korean	c1 = FEH	A1H ≤ c2 ≤ FEH

0 ≤ d ≤ 255
 k = 32

- [Description]
- Defines the user-defined character pattern for the specified character codes.
 - c1 specifies the first byte of a character code, c2 specifies the second byte of a character code.
 - d specifies the defined data (column format).
- [Notes]
- The maximum number of characters that can be defined is 5.
 - When the maximum number of user-defined Kanji characters is defined, it is possible to redefine user-defined Kanji characters for the defined character code, but not for the new character code.

EPSON	TITLE	SHEET REVISION	NO.	
	TM-U220 series Specification (STANDARD)		B	NEXT 120

FS ? c1 c2

[Name] Cancel user-defined Kanji characters

[Format] ASCII FS ? c1 c2
 Hex 1C 3F c1 c2
 Decimal 28 63 c1 c2

[Range] The ranges differ, depending on specifications and the character code system used.

Model	c1	c2
Japanese (JIS code)	c1 = 77H	21H ≤ c2 ≤ 7EH
Japanese (SHIFT JIS code)	c1 = ECH	40H ≤ c2 ≤ 7EH 80H ≤ c2 ≤ 9EH
Simplified Chinese (GB18030 and GB2312) Traditional Chinese Korean	c1 = FEH	A1H ≤ c2 ≤ FEH

[Description] • Cancels the user-defined character pattern for the specified character codes.
 • c1 specifies the first byte of a character code, c2 specifies the second byte of a character code.

FS C n

[Name] Select Kanji character code system

[Format] ASCII FS C n
 Hex 1C 43 n
 Decimal 28 67 n

[Range] n = 0, 1, 48, 49

[Default] n = 0

[Description] • Selects a Kanji character code system for the Japanese model.

n	Kanji character code system
0, 48	JIS code
1, 49	SHIFT JIS code

FS S $n1$ $n2$

[Name]	Set Kanji character spacing				
[Format]	ASCII	FS	S	$n1$	$n2$
	Hex	1C	53	$n1$	$n2$
	Decimal	28	83	$n1$	$n2$
[Range]	$0 \leq n1 \leq 32$ $0 \leq n2 \leq 32$				
[Default]	$n1 = 0$, $n2 = 2$				
[Description]	<ul style="list-style-type: none">• Sets the left-side character spacing of the multi byte code character to [$n1 \times$ (horizontal motion unit)], the right-side character spacing of the multi byte code character to [$n2 \times$ (horizontal motion unit)].				

FS W n

[Name]	Turn quadruple-size mode on/off for Kanji characters			
[Format]	ASCII	FS	W	n
	Hex	1C	57	n
	Decimal	28	87	n
[Range]	$0 \leq n \leq 255$			
[Default]	$n = 0$			
[Description]	<ul style="list-style-type: none">• Turns quadruple-size mode on or off for multi-byte code characters.<ul style="list-style-type: none">• When the LSB of n is 0, quadruple-size mode is turned off.• When the LSB of n is 1, quadruple-size mode is turned on.			

EPSON	TITLE TM-U220 series Specification (STANDARD)	SHEET REVISION B	NO.	
			NEXT 122	SHEET 121

6.4 Obsolete Commands

ESC i

[obsolete command]

GS V, which is the upward-compatible command replacing **ESC i**, is recommended for use, since **ESC i** is an obsolete command in the ESC/POS[®] command system.

[Name] Partial cut (one point left uncut)

[Format] ASCII ESC i
Hex 1B 69
Decimal 27 105

[Description] • Executes a partial cut of the roll paper.

- [Notes] • Type of cutting is set with the installation position of the autocutter.
- Partial cut (one point left uncut)
 - Full cut

ESC m

[obsolete command]

GS V, which is the upward-compatible command replacing **ESC m**, is recommended for use, since **ESC m** is an obsolete command in the ESC/POS[®] command system.

[Name] Partial cut (three points left uncut)

[Format] ASCII ESC m
Hex 1B 6D
Decimal 27 109

[Description] • Executes a partial cut of the roll paper.

- [Notes] • Type of cutting is set with the installation position of the autocutter.
- Partial cut (one point left uncut)
 - Full cut

EPSON	TITLE TM-U220 series Specification (STANDARD)	SHEET REVISION B	NO.	
			NEXT 123	SHEET 122

ESC u n

[obsolete command]

GS r, which is the upward-compatible command replacing **ESC u**, is recommended for use, since **ESC u** is an obsolete command in the ESC/POS® command system.

[Name] Transmit peripheral device status

[Format] ASCII ESC u n
Hex 1B 75 n
Decimal 27 117 n

[Range] n = 0, 48

[Description] • Transmits the peripheral device status as 1 byte of data, as follows.

Bit	Off/On	Hex	Decimal	Status
0	Off	00	0	Drawer kick out connector pin 3 is LOW.
	On	01	1	Drawer kick out connector pin 3 is HIGH.
1 ~ 3	--	--	--	Reserved.
4	Off	00	0	Fixed.
5, 6	--	--	--	Reserved.
7	Off	00	0	Fixed.

[Note] • When this command is transmitted, the following status must not be transmitted until the status is received.

ESC v

[obsolete command]

GS r, which is the upward-compatible command replacing **ESC v**, is recommended for use, since **ESC v** is an obsolete command in the ESC/POS® command system.

[Name] Transmit paper sensor status

[Format] ASCII ESC v
Hex 1B 76
Decimal 27 118

[Description] • Transmits the status of paper sensor(s) as 1 byte of data, as follows.

Bit	Off/On	Hex	Decimal	Status
0, 1	Off	00	0	Roll paper near-end sensor: paper adequate.
	On	03	3	Roll paper near-end sensor: paper near end.
2, 3	Off	00	0	Roll paper end sensor: paper present.
	On	0C	12	Roll paper end sensor: paper not present.
4	Off	00	0	Fixed.
5, 6	--	--	--	Reserved.
7	Off	00	0	Fixed.

Bits 0 and 1: The roll paper near-end sensor is an option: on units that do not have this option, bits 0 and 1 are "0" (paper adequate).

[Note] • When this command is transmitted, the following status must not be transmitted until the status is received.

EPSON	TITLE TM-U220 series Specification (STANDARD)	SHEET REVISION B	NO.	
			NEXT App.1	SHEET 123

APPENDIX A: MISCELLANEOUS NOTES

1) Notes on printer installation

- Connect the external power supply to the power supply connector of the printer. Then plug in the external power supply and turn it on if necessary. Be sure not to connect the external power supply with the wrong polarity. If it is connected incorrectly, the internal circuit fuse of the printer may be blown or the external power supply may be damaged.
- The power supply voltage is within the range of 24 V ± 7%. If the power supply voltage drops to a value outside the range above during printing, the printer stops printing and waits until the voltage returns to normal and then automatically begins printing again. If the voltage does not return to normal, the printer generates an error. Therefore, printing speed may slow, the print pitch may not be correct, and some dots in some characters may not be printed.
- Both high and low voltage errors are shown in Table 3.8.3. The flashing patterns are shown in the table.
- When either a high or low voltage error occurs, turn off the power as soon as possible.

2) Print duty control

The printer performs the print duty control to avoid print head damage from exceeding the print duty or lower print quality from rapid power voltage drop.

- When printing exceeds the allowable print duty cycle depending on the usage conditions such as the number of print columns or the continuous print period, the printer automatically detects the print head temperature rise, stops logic-seeking, and enters full-column print head movement operation. This stops the temperature rise by lowering print duty. If the print head temperature continues to rise, the printer stops the print head intermittently. In this case, the user should be aware that the printing speed may slow significantly.
- When printing is stopped due to high print head temperature, the ERROR LED flashes as shown in Table 3.5.1, Automatically Recoverable Errors, and the printer goes offline if the DIP SW 1-8 is off. The printer automatically goes back online when the print head temperature falls.
- The upper limiting conditions on continuous printing are as follows when the printer enters full-column print head movement operation. (An example test pattern is shown in Figure A.1 or A.2.)

- [Conditions]
- Maximum continuous printing time: 1 hour
 - Ambient temperature: 25°C {77°F}
 - Print head duty: The number of print columns must be 15 or less in full-column print head movement operation.

- The upper limiting conditions on continuous printing are as follows when the printer enters the print duty control operation.

- [Conditions]
- Ambient temperature: 25°C {77°F}
 - Print head duty: 30 columns
 - Number of lines continuously printed: 3,000 lines
 - Total print time: Approximately 15 minutes

EPSON	TITLE	TM-U220 series Specification (STANDARD)	SHEET REVISION	NO.	
			B	NEXT App.2	SHEET App.1

Confidential

- Under the conditions listed below, the printer changes the print mode to 3.5 lps (40 columns per line with 16 cpi, at 1/6" line spacing) and performs the print duty control by detecting the print head temperature automatically to avoid trouble caused by rapid power voltage drop.
 - Various bit-image printing
 - Various character style printing (only in ANK model)
 - User defined character printing
 - When selecting a character consisting of 25 dots or more defined in the character code page
- [lps: lines per second]
 [cpi: characters per 25.4 mm {1"}]

3) Print color selection duty

Do not switch the print color frequently. When a black-red-black or red-black-red color selection sequence is regarded as 1 switching, the user should perform switching according to the rate shown below.

B: Print color switching rate

$$B \leq \frac{2 \text{ switches}}{15 \text{ lines of printing}}$$

4) Data transmission

Data should be transmitted after the printer power is turned on and the initializing operation is completed.

5) Manual cutter

The roll paper should be cut off after finishing paper feed. After cutting the roll paper, the paper should always be fed 1.235 mm {7/144 inches} before any subsequent print (to cancel the gear backlash).

6) Reverse paper feed

Normally, the printer can feed paper maximum 1 line (including the gear backlash) in the reverse direction. When **ESC K** or **ESC e** is executed, the printer can feed maximum 8.467 mm {48/144 inches} (including the gear backlash) in the reverse direction.

EPSON	TITLE TM-U220 series Specification (STANDARD)	SHEET REVISION B	NO.	
			NEXT App.3	SHEET App.2

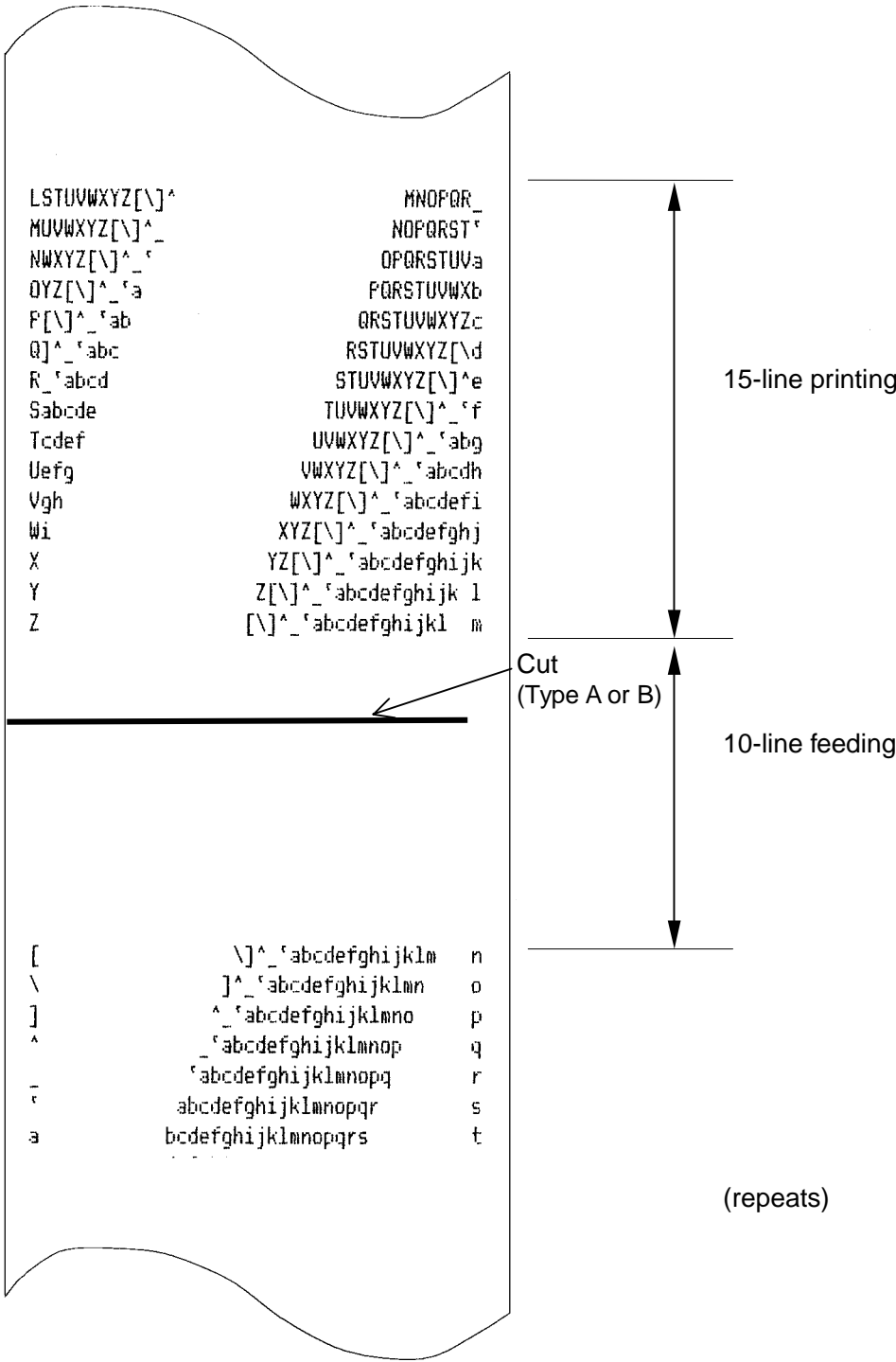

Figure A.1 Continuous Printing Test Pattern (Using the ERC-38(P)/(B))

EPSON	TITLE TM-U220 series Specification (STANDARD)	SHEET REVISION B	NO.	
			NEXT App.4	SHEET App.3

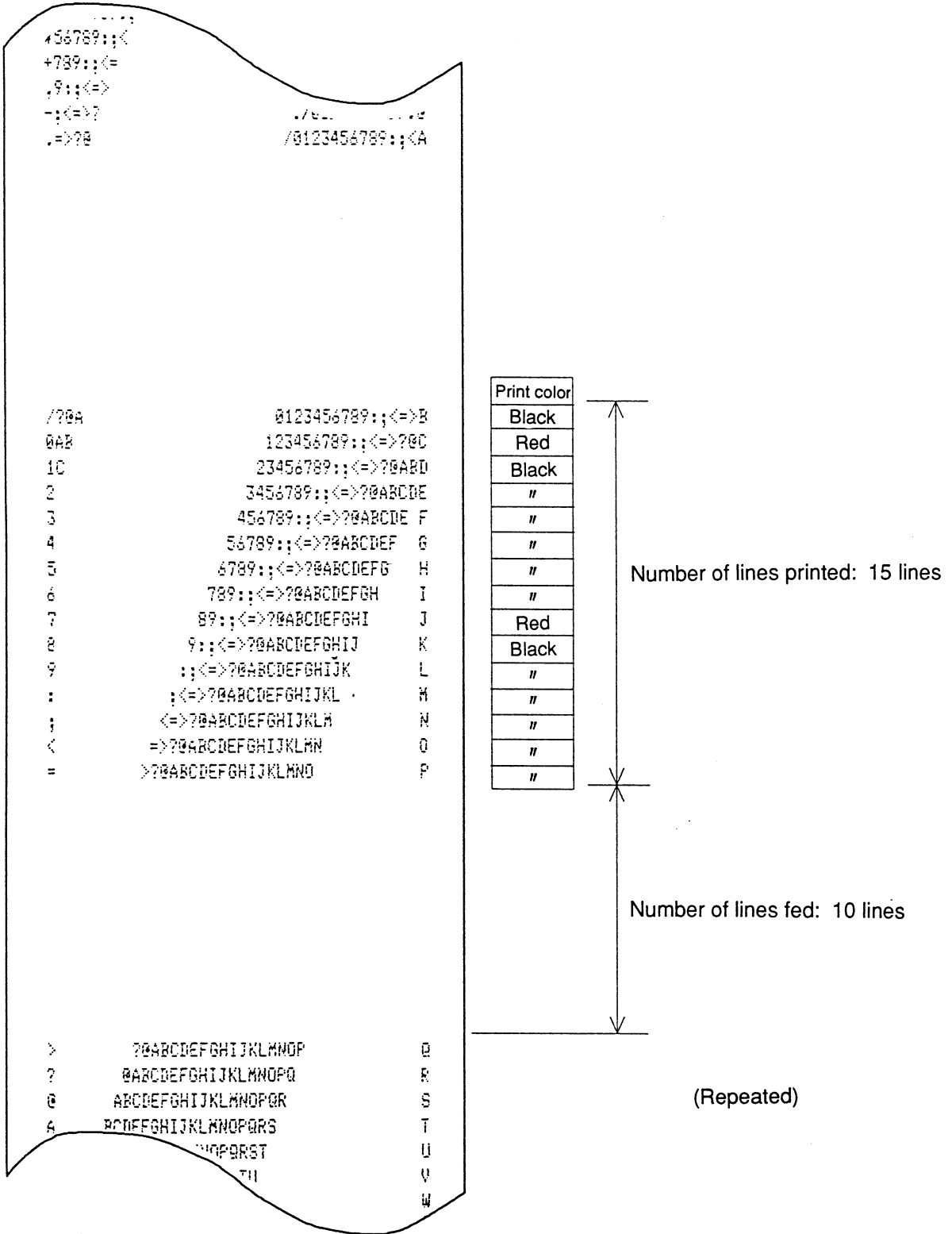

Figure A.2 Continuous Printing Test Pattern (Using the ERC-38(B/R))

EPSON	TITLE	TM-U220 series Specification (STANDARD)	SHEET REVISION	NO.	
			B	NEXT App.5	SHEET App.4

7) Recovery from an autocutter error

If a foreign object such as a push pin or paper clip drops in the autocutter and causes the autocutter to lock up, the printer enters an error state and begins the recovery operation automatically. (The ERROR LED blinks continuously, but it is possible for the error to be corrected automatically.)

If the problem is not serious, the autocutter returns to its normal position without any intervention by the user.

If the autocutter does not return to its normal position by itself, open the paper roll cover, then remove the error cause, then close the paper roll cover.

Then send the **DLE ENQ n** command. Next, check the ERROR LED. If the ERROR LED is not off, repeat the same procedure and confirm that the ERROR LED is off. When the ERROR LED is off, the autocutter blade has returned to its normal position.

8) Other notes

- Because this printer uses plated steel, the cutting edges may be subject to rust.
- Never touch the neighborhood of the print head while printing or just after printing because it becomes high temperature.
- Do not open the cover while printing or autocuttring. (Otherwise, the printer mechanism may be damaged.)

EPSON	TITLE	TM-U220 series Specification (STANDARD)	SHEET REVISION	NO.	
			B	NEXT App.6	SHEET App.5

APPENDIX B: ADJUSTING THE AMOUNT OF ROLL PAPER REMAINING

Because the amount of paper remaining on a roll differs according to the inner and outer diameters of the core of the roll, the positioning plate can be used to adjust the amount remaining within the range indicated below. The plate is tightened with the tightening screws, as shown in the diagram below.

- 1) The inner diameter of the core should be from 10.5 mm to 12.5 mm {0.41 to 0.49"}. (Refer to Section 1.4, "Roll Paper Supply Unit.")
Refer to Table B.1 for the thickness of the roll paper core.
- 2) Loosen the adjusting screw that holds the paper near-end sensor and set the top of the positioning plate to the appropriate adjustment value and tighten the adjusting screw.
- 3) Dimension "A" to be detected is different for the detecting position of the near-end sensor and the thickness of the roll paper core.

Table B.1 Adjustment Position and the Amount Remaining "A"

Thickness of roll paper core Adjustment position	Less than 3 mm	Over 3 mm and less than 6 mm	More than 6mm
Upper	Approximately 8 mm	Approximately 8 mm	Impossible to set (cannot detect near-end)
Lower	Approximately 5 mm	Impossible to set (cannot detect near-end)	Impossible to set (cannot detect near-end)

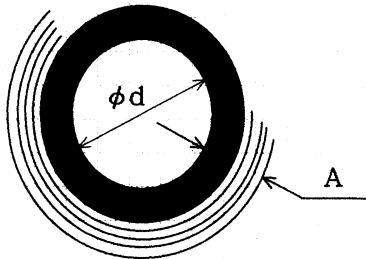

Figure B.1 Adjustment Positions

- NOTES:
- 1) Since the specified thermal paper dimension of the outside diameter of roll paper in Table C.1 is a calculated value, there may be some variations depending on the printer.
 - 2) If the end of the roll paper has with a red end mark, the end mark may lift up all of the roll paper. In this case, the remaining roll paper as measured by A in Table B.1 cannot be obtained.
 - 3) Be sure that the detection lever operates smoothly after you finish the adjustment.
 - 4) The paper quality may cause the roll paper to become loose and result in incorrect detection.

EPSON	TITLE	TM-U220 series Specification (STANDARD)	SHEET REVISION	NO.	
			B	NEXT App.7	SHEET App.6

APPENDIX C: ROLL PAPER SETUP

C.1 Loading the Roll Paper

For Type B or D

- 1) Open the cover by pressing the cover open lever.
- 2) Load the new roll paper and pull out some of the paper from the roll paper.
- 3) Close the printer cover.
- 4) Cut the paper manually.

For Type A

- 1) Pull up the roll paper cover open lever so that the roll paper cover is open.
- 2) Cut the journal paper and remove the take-up spool.
- 3) Pull up the platen open lever (blue lever) so that the platen is unloaded.
- 4) Set the roll paper and pull the tip of the paper out. The length would be better if the top of the paper reaches to the button of the front part of the printer.
- 5) Load the platen and set the take-up spool; then insert the journal paper to the groove of the take-up spool.
- 6) Check that the journal paper is taken up by the take-up spool by pressing the paper FEED button.
- 7) Close the roll paper cover.
- 8) Cut the extra roll paper manually.

- NOTES:
- The printer feeds for 30 mm automatically if the roll paper cover is open. This is a normal operation to prevent the printer from damaging the paper when the roll paper cover is opened or closed.
 - Since the printer does not feed even if the roll paper cover is open when the printer is turned off, make sure not to pinch the paper when the cover is closed.

EPSON	TITLE TM-U220 series Specification (STANDARD)	SHEET REVISION B	NO.	
			NEXT App.8	SHEET App.7

APPENDIX D: NOTES ON CHARACTER PRINTING

Applied for the user-defined characters and the following characters.

Font	Page	Character code
7 × 9	0	<B0>H, <B2>H
9 × 9	1	<E5>H, <E7>H
9 × 9	0	<B2>H

1) The printer deletes the right-most dots of a character during double-width mode, if another character follows.

If the characters shown above are double-width enlarged (dots exist in the right-most position), the right-most dots of the enlarged character are not printed, as shown in the figure below.

Example: 7 × 9 font is selected

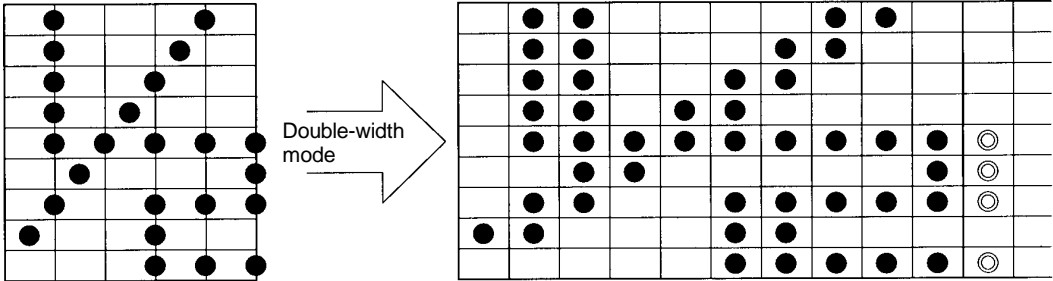

- ⊙ dots are not printed when another character follows.
- ⊙ Dots are printed when no character follows. (except ⊙ dots on 401st dot position)

Figure D.1 7 × 9 Font

2) The printer cannot print horizontally adjacent half dots. A special procedure that avoids horizontally adjacent half dots is used when print data is buffered in the print buffer. Therefore, some dots in the character that follows the characters prescribed above are not printed because of the effect of the previous dots. Also, when double-height mode is selected, the dots affected by the previous dots are not printed, as shown in the following figure, because double-height processing is carried out during printing after the print pattern is buffered in the print buffer. To avoid this, program the software so that half dots are not adjoined horizontally. (For example, set the right side spacing of a character to 1 or more (**ESC SP**), etc.) In this case the user should note that the total number of dots in the horizontal direction is 400 dots.

EPSON	TITLE TM-U220 series Specification (STANDARD)	SHEET REVISION B	NO.	
			NEXT App.9	SHEET App.8

Confidential

Example: If the following codes are transmitted, some dots are not printed.

(Graphic character H<B2> + "H" double-height enlarged)

```
PRINT #1, CHR$ (&HB2) ;
PRINT #1, CHR$ (&H1B); "!"; CHR$ (&H11);
PRINT #1, "H"; CHR$ ($HA) ;
```

When the data is buffered in the print buffer

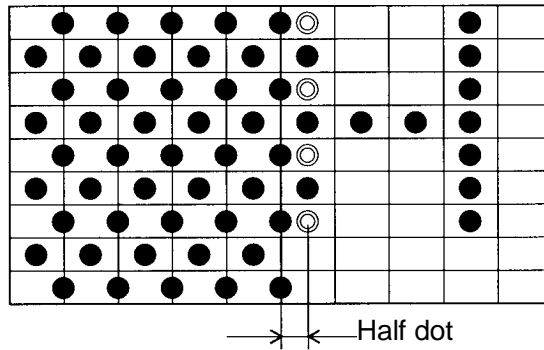

⊙ dots are deleted because of the next character and not printed.

Printing result (unidirectional printing)

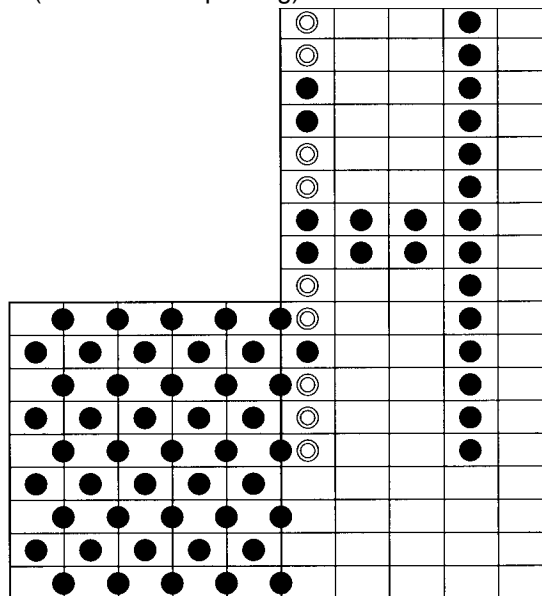

⊙ dots are not printed.

To avoid this, program the software as follows.

(Set the right-side spacing of the graphic character (H<B2>) to 1.)

```
PRINT #1, CHR$ (&H1B) ; " "; CHR$(1) ; CHR$(&HB2) ;
PRINT #1, CHR$ (&H1B); "!"; CHR$ (&H11);
PRINT #1, "H"; CHR$ ($HA) ;
```

EPSON	TITLE	SHEET REVISION	NO.	
	TM-U220 series Specification (STANDARD)	B	NEXT App.10	SHEET App.9

APPENDIX E: NOTES ON USING THE DRAWER KICK-OUT CONNECTOR

1) Drawer specifications (see Section 2.2.3, Drawer kick-out connector)

Drawer specifications differ significantly depending on manufacturer and model number. Make sure that the specifications of the drawer used meet the following conditions when connected to the drawer kick-out connector. These conditions also apply to any equipment (other than a drawer) that is connected to the drawer kick-out connector.

Never use a drawer (or other equipment) that does not meet all of the following conditions:

- The load, such as a drawer kick-out solenoid, must be connected between pins 4 and 2 or pins 4 and 5 of the drawer kick-out connector. (*1)
- When the drawer open/close signal (indicating the state of the drawer) is used, a switch must be provided between drawer kick-out connector pins 3 and 6. (*2)
- The resistance of the load, such as a drawer kick-out solenoid, must be 24 Ω or more or the input current must be 1 A or less. (*3)
- Be sure to use the 24 V power output on drawer kick-out connector pin 4 for driving the equipment. Never connect any other power supply to the drawer kick-out connector. (*4) The peak current is 1 A. See item 2) below for drive signal duty.

- NOTES : (*1): Proper operation is not guaranteed with different connections.
 (*2): Proper operation is not guaranteed with different connections or connection to a component other than a switch.
 (*3): Connection to equipment whose resistance is less than 24 Ω or less or whose input current is more than 1 A or more may damage the connected equipment as well as the printer.
 (*4): Operation is not guaranteed with other power supplies.

2) Notes on the pulse generating command (**ESC p**)

When using **ESC p** to drive the drawer connected to the drawer kick-out connector, set the command parameters to meet the following conditions:

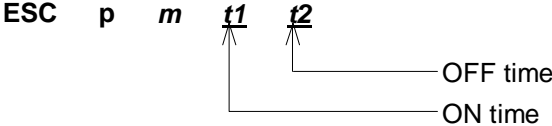

$$\frac{\text{ON time}}{\text{ON time} + \text{OFF time}} \leq 0.2 \dots\dots\dots \text{Formula E-1}$$

or, OFF time ≥ ON time × 4 Formula E-2

EPSON	TITLE	TM-U220 series Specification (STANDARD)	SHEET REVISION	NO.	
			B	NEXT App.11	SHEET App.10

The drive signal waveform generated when the drawer is driven according to the above conditions is shown in Figure E.1.

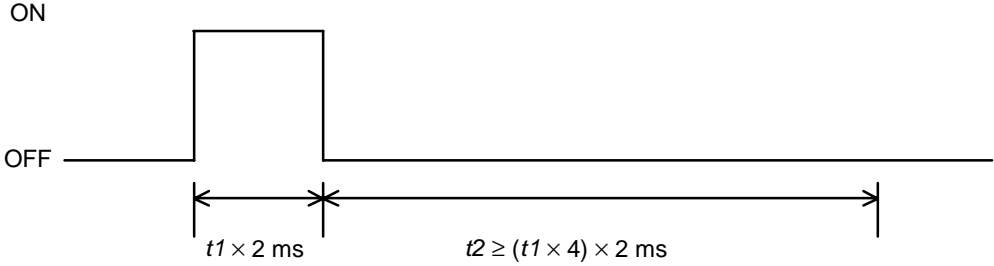

Figure E.1 Drawer Drive Signal Waveform (Formulas E-1 and E-2)

The ON time depends on the specifications of the drawer used. Be sure to check the drawer specifications and set a suitable time. To use a drawer that does not meet the conditions of Formulas E-1 and E-2, see the following section.

3) Using a drawer that does not meet the conditions in 2)

Setting the values of $t1$ and $t2$ according to the conditions in 2) results in a maximum ON time of 126 ms ($0 \leq t1 \leq 63$), since the setting ranges of $t1$ and $t2$ are 0 to 255. To use a drawer that requires an ON time exceeding 126 ms, the following conditions must be met:

$$\frac{\text{ON time}}{\text{ON time} + \text{OFF time}} + \alpha \leq 0.2 \dots\dots\dots \text{Formula E-3}$$

α : other sequence processing time

NOTE: α is the period when drawer-driving is prohibited from the OFF time until the next ON time.

EPSON	TITLE	TM-U220 series Specification (STANDARD)	SHEET REVISION	NO.	
			B	NEXT App.12	SHEET App.11

Confidential

An example program in which the drawer connected to drive signal 1 is driven with an ON time of 200 ms is shown below.

```

PRINT #1, CHR$(&H1B);"p";CHR$(0);CHR$(100);CHR$(250);
GOSUB *WAIT300MS
    *WAIT300MS
    300 [ms] wait routine (*1)
RETURN
    
```

ON time 200 ms OFF time 500 ms

*1 Corresponds to α of Formula E-3. Set the value so that it satisfies Formula E-3 (or include an internal processing time that is equal to or longer than this wait routine).

The drive signal waveform generated when the drawer is driven according to the above conditions is shown in Figure E.2.

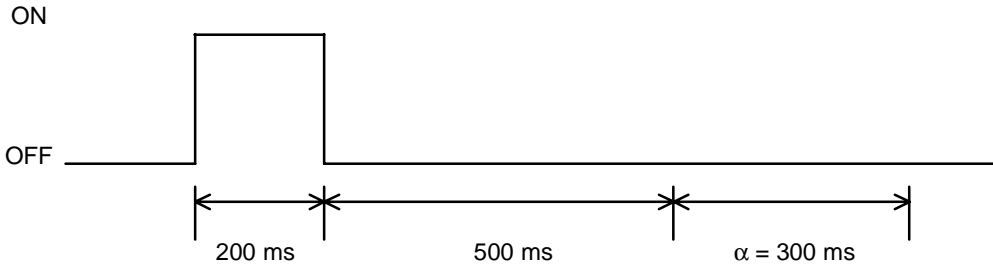

Figure E.2 Drawer Drive Signal Waveform

EPSON	TITLE	SHEET REVISION	NO.	
	TM-U220 series Specification (STANDARD)	B	NEXT App.13	SHEET App.12

APPENDIX F: CHANGING THE PAPER GUIDE SPACER

Change the position of the paper guide spacer if the different paper-width paper is used as follows:

- Remove two screws for the paper guide.
- Lift the paper guide spacer so that two convex shapes (approximately 4 mm / approximately 2 mm) of the paper guide spacer are removed from the paper roll holder.
- Set the paper guide spacer so that two convex shapes (approximately 4 mm / approximately 2 mm) of the paper guide spacer fit into the holes of the paper roll holder.
- There are three positions – 76 mm, 69.5 mm, and 57.5 mm available.
- Be sure not to pinch the lead wires of the near-end detector between the paper guide spacer and the roll paper holder, and to push the lead wires inside so that the lead wire of the paper-end detector does not contact the motor gear (for the model with the near-end detector).
- Secure two screws for the paper guide spacer.

EPSON	TITLE TM-U220 series Specification (STANDARD)	SHEET REVISION B	NO.	
			NEXT END	SHEET App.13