

Specification

Using this online Specification

The words on the left side of this screen are bookmarks for all the topics in this guide.

Use the scroll bar next to the bookmarks to find any topic you want. Click a bookmark to instantly jump to its topic. (If you wish, you can increase the size of the bookmark area by dragging the dividing bar to the right.)

Use the scroll bar on the right side of this screen to move through the text.



Use the zoom tools to magnify or reduce the page display.



Click the Find button if you want to search for a particular term. (However, using the bookmarks is usually quicker.)

Complete online documentation for Acrobat Reader is located in the Help directory for Acrobat Reader.

[Return to main menu](#)

Confidential

EPSON

One-Station Printer

TM-U200 series

Specification

STANDARD	
Rev. No.	I
Notes	

Copied Date	
Copied by	

SEIKO EPSON CORPORATION

MATSUMOTO MINAMI PLANT

2070 KOTOBUKI KOAKA, MATSUMOTO-SHI, NAGANO, 399-8702 JAPAN

PHONE(0263)86-5353 FAX(0263)86-9923

REVISION SHEET

The table below indicates which pages in this specification have been revised.
 Before reading this specification, be sure you have the correct version of each page.

Revisions		Design Section			Sheet Rev. No.						
Rev.	Document	WRT	CHK	APL	Sheet	Rev.	Sheet	Rev.	Sheet	Rev.	
A	Enactment	N.Asai	N.Asai	K.Itoh	I	I	17	I	41	I	
B	Change	N.Asai	N.Asai	K.Itoh	II	I	18	I	42	I	
C	Change	Kawakami	N.Asai	N.Asai	III	I	19	I	43	I	
D	Change	Kawakami	N.Asai	K.Itoh	IV	I	20	I	44	I	
E	Change	N.Asai	N.Asai	R.Kanai	V	I	21	I	45	I	
F	Change	I.Nakayama	--	R.Kanai	VI	I	22	I	46	I	
G	Change	I.Nakayama	N.Asai	R.Kanai			23	I	47	I	
H	Change	I.Nakayama	N.Asai	R.Kanai			24	I	48	I	
I	Change				1	I	25	I	49	I	
					2	I	26	I	50	I	
					3	I	27	I	51	I	
					4	I	28	I	52	I	
					5	I	29	I	53	I	
					6	I	30	I	54	I	
					7	I	31	I	55	I	
					8	I	32	I	56	I	
					9	I	33	I	57	I	
					10	I	34	I	58	I	
					11	I	35	I	59	I	
					12	I	36	I	60	I	
					13	I	37	I	61	I	
					14	I	38	I	62	I	
					15	I	39	I	63	I	
					16	I	40	I	64	I	
TITLE TM-U200 series Specification (STANDARD)				Front Part					Contents	Appendix	Total
				Cover	Rev. Sheet	Scope	General Descriptions	Table of Contents			
				1	6	-	3	3			

REVISION SHEET

The table below indicates which pages in this specification have been revised.
 Before reading this specification, be sure you have the correct version of each page.

Revisions		Design Section			Sheet Rev. No.							
Rev.	Document	WRT	CHK	APL	Sheet	Rev.	Sheet	Rev.	Sheet	Rev.		
A	Enactment				65		89		App.8			
B	Change				66		90		App.9			
C	Change				67		91		App.10			
D	Change				68		92		App.11			
E	Change				69		93		App.12			
F	Change				70		94		App.13			
G	Change				71		95					
H	Change				72		96					
I	Change				73		97					
					74		98					
					75		99					
					76		100					
					77		101					
					78		102					
					79		103					
					80		104					
					81							
					82		App.1					
					83		App.2					
					84		App.3					
					85		App.4					
					86		App.5					
					87		App.6					
					88		App.7					
TITLE TM-U200 series Specification (STANDARD)					Front Part					Contents	Appendix	Total
					Cover	Rev. Sheet	Scope	General Descriptions	Table of Contents			
					1	6	-	3	3			
					104	13	130					

REVISION SHEET

REV.	SHEET	CHANGED CONTENTS
B		Major change of this revision is the addition of bidirectional parallel interface. See below for detail.
	all sheets	Sheet title TM-U200D → TM-200U/PD (Change)
	I	Application Apply to TM-U200D. → Apply to TM-U200D(RS-232 serial interface specification) or to TM-U200PD(IEEE 1284 bidirectional parallel interface specification). (Change)
	II ~ VI	Table of contents (Change)
	5	When one original and two copies...slightly curl. (Addition)
	14 ~ 19	2.1.2 IEEE 1284 bidirectional parallel interface (Addition)
	20	2.2 Connectors Figure 2.2.2 (Addition)
	24	3.1.2 Command list ESC c 3 command (Addition)
		GS V command
	35	DIP switch settings for parallel interface (Addition)
	48	CR command details (Addition)
	67	ESC c 3 command details (Addition)
	74	GS V command (Addition)
	81	6.5 Ignored Command The parallel... ESC c 6 n (Addition)
	App12 ~ App29	APPENDIX G Bidirectiond Parallel Interface (Addition)
C		Major change of this revision is the addition of the color printing specifications.
<p>TITLE</p> <p style="text-align: center;">TM-U200 series Specification (STANDARD)</p>		

REVISION SHEET

REV.	SHEET	CHANGED CONTENTS
E	I	General Description This specifications interface specification (Change)
	6	1.10 Reliability 1) Life of 7.5 million lines. (Change)
	34,35	3.3.3 DIP Switches Addition of the print head type. (Change)
F	I	The applied models of this specification are changed.
	VI	This page is intentionally blanked due to the deletion of Appendix G.
	4	1.4 Roll Paper Supply Unit Note:by glue ... →by tape or glue ... 1.5 Paper Specifications Glued type cannot → Glued type such as tape cannot ... "Number of copies:" is newly added.
	5	(b) Copying capability "Affected model types" are newly added
	6	1.9 Electrical Specifications Europe (U.K) 240V±10% → 230V±10%
	7	1.11 Reliability 1) Life Print color switching and Auto cutter are added.
	19	2.1.1.9 1)100 bytes ... → 99 bytes ...
	24	3.1 Commands ESC c 3[(Only for parallel interface model)] is newly added. GS V[(Only for auto-cutter equipped model)] is deleted.
	35	Table 3.3.3 and Table 3.3.6 *1: (Fixed to OFF) is deleted.
	36	Table 3.5.2 Auto cutter error (only for ... model) → Auto cutter error.
	37	Table 3.5.3 Pulse width unit is moved to below.
	41-41-1	4. Case specifications 'Inch' unit is added to all dimensions.
	42	5.1 Standard Accessories Europe (U.K) 240V → 230V
43	5.2 Options • External power supply PS-150 → AC adapter PS-170 5.3 Interface Board [RS-485..... (Option)] is newly added	
TITLE		TM-U200 series Specification (STANDARD)

REVISION SHEET

REV.	SHEET	CHANGED CONTENTS
F	50	DLE EOT <i>n</i> [Reference] [3.5.1 Error types] is newly added.
	52	ESC SP <i>n</i> [Description] [$n \times (1/160)$] inches → [$n \times 0.159$ mm {1/160 inches}].
	63	ESC T <i>n</i> and ESC K [$n \times (1/144)$] inches → [$n \times 0.176$ mm {1/144 inches}]
	70	ESC e <i>n</i> 48/144 inch → 8.467 mm {48/144 inches}
	70-1	ESC r <i>n</i> [Notes] [•This command printing model] is newly added.
	74	GS V and GS V <i>m n</i> [Description] ... [$n \times (1/144)$ inches] → [$n \times 0.176$ mm {1/144 inches}] and partial cut.
	77	GS a <i>n</i> [Reference][3.5.1 Error types] is newly added.
	App.2	Figure A-1. (TM-U200B/PB only) → (Type B only)
	App.3	Appendix B Section 1.5 "Paper Specifications" → Section 1.4 "Roll Paper Supply Unit"
	App12 –App.29	Appendix G All descriptions are deleted.
G	20	2.2 Connectors Figure 2.2.1, Figure 2.2.2, and Figure 2.2.3 Change of the figures for power supply connector.
H	All	<ul style="list-style-type: none"> • All page numbers are re-numbered. • Descriptions for model type A/AM are added.
I	All	<ul style="list-style-type: none"> • "Confidential" is written on the header of all pages. • Descriptions for a multilingual supporting model of the type AM are added.
<p>TITLE</p> <p style="text-align: center;">TM-U200 series Specification (STANDARD)</p>		

CONFIDENTIALITY AGREEMENT

BY USING THIS DOCUMENT, YOU AGREE TO ABIDE BY THE TERMS OF THIS AGREEMENT. PLEASE RETURN THIS DOCUMENT IMMEDIATELY IF YOU DO NOT AGREE TO THESE TERMS.

1. This document contains confidential, proprietary information of Seiko Epson Corporation or its affiliates. You must keep such information confidential. If the user is a business entity or organization, you must limit disclosure to those of your employees, agents and contractors who have a need to know and who are also bound by obligations of confidentiality.
2. On the earlier of (a) termination of your relationship with Seiko Epson, or (b) Seiko Epson's request, you must stop using the confidential information. You must then return or destroy the information, as directed by Seiko Epson.
3. If a court, arbitrator, government agency or the like orders you to disclose any confidential information, you must immediately notify Seiko Epson. You agree to give Seiko Epson reasonable cooperation and assistance in resisting disclosure.
4. You may use confidential information only for the purpose of operating or servicing the products to which the document relates, unless you obtain the prior written consent of Seiko Epson for some other use.
5. Seiko Epson warrants that it has the right to disclose the confidential information. SEIKO EPSON MAKES NO OTHER WARRANTIES CONCERNING THE CONFIDENTIAL INFORMATION OR ANY OTHER INFORMATION IN THE DOCUMENT, INCLUDING (WITHOUT LIMITATION) ANY WARRANTY OF TITLE OR NON-INFRINGEMENT. Seiko Epson has no liability for loss or damage arising from or relating to your use of or reliance on the information on the document.
6. You may not reproduce, store or transmit the confidential information in any form or by any means (electronic, mechanical, photocopying, recording, or otherwise) without the prior written permission of Seiko Epson.
7. Your obligations under this Agreement are in addition to any other legal obligations. Seiko Epson does not waive any right under this Agreement by failing to exercise it. The laws of Japan apply to this Agreement.

CAUTIONS

1. This document shall apply only to the product(s) identified herein.
2. No part of this document may be reproduced, stored in a retrieval system, or transmitted in any form or by any means, electronic, mechanical, photocopying, recording, or otherwise, without the prior written permission of Seiko Epson Corporation.
3. The contents of this document are subject to change without notice. Please contact us for the latest information.
4. While every precaution has been taken in the preparation of this document, Seiko Epson Corporation assumes no responsibility for errors or omissions.
5. Neither is any liability assumed for damages resulting from the use of the information contained herein.
6. Neither Seiko Epson Corporation nor its affiliates shall be liable to the purchaser of this product or third parties for damages, losses, costs, or expenses incurred by the purchaser or third parties as a result of: accident, misuse, or abuse of this product or unauthorized modifications, repairs, or alterations to this product, or (excluding the U. S.) failure to strictly comply with Seiko Epson Corporation's operating and maintenance instructions.
7. Seiko Epson Corporation shall not be liable against any damages or problems arising from the use of any options or any consumable products other than those designated as Original EPSON Products or EPSON Approved Products by Seiko Epson Corporation.

TRADEMARKS

EPSON® and ESC/POS® are registered trademarks of Seiko Epson Corporation.

General Notice: Other product and company names used herein are for identification purposes only and may be trademarks of their respective companies.

	TITLE TM-U200 series Specification (STANDARD)	SHEET REVISION I	NO.	
			NEXT II	SHEET I

General Description

This specifications applies to the TM-U200 series standard specifications.

Model type		Two-color printing	Auto cutter equipped	Take-up device equipped	Printing characters	Interface
A		Yes	Yes	Yes	ANK	Serial / Parallel
AM	Japanese Kanji supporting	Yes	Yes	Yes	ANK + Japanese Kanji	Serial / Parallel
	Multilingual characters supporting (*1)	Yes	Yes	Yes	ANK + Multilingual characters	Serial
B		Yes	Yes	--	ANK	Serial / Parallel
D		Yes or No (Single)	--	--	ANK	Serial / Parallel

NOTE *1: Multilingual characters means that the printer can print with one of Chinese Kanji, Taiwanese Kanji or Thai characters.

EPSON	TITLE TM-U200 series Specification (STANDARD)	SHEET REVISION I	NO.	
			NEXT III	SHEET II

Features

This printer was developed on the basis of the high cost-performance design concept.

This printer, is a one-station printer that is light, offers excellent reliability, The design of this printer also emphasizes the needs of the user.

- Compact and lightweight
- High-speed printing through logical seeking control
- Excellent reliability and long life due to adoption of stepping motor, both for moving the carriage and for paper feeding
- Flexible paper feed pitch setting permits printing in accordance with any user-defined format
- Conforms with ESC/POS™; excellent universality of control
- Built-in drawer-kick interface provides capability to drive two drawers
- Selectable character fonts (7 × 9, 9 × 9)
- Semi-automatic paper loading capability
- AC adapter provides compact power supply
- Automatic status back (ASB) function that automatically transmits changes in printer status.
- Two-color printing (black and red). (2-color print version only)
- Auto cutter is equipped. (for TM-U200 type A, type AM, type B)
- Take-up device is equipped. (for TM-U200 type A, type AM)

These and other features make this printer highly suitable for the POS one-station printer market.

EPSON	TITLE TM-U200 series Specification (STANDARD)	SHEET REVISION I	NO.	
			NEX. IV	SHEET III

TABLE OF CONTENTS

I. BASIC SPECIFICATIONS	1
1.1 Printing Specifications	1
1.2 Character Specifications.....	1
1.3 Ribbon Cassette	3
1.4 Roll Paper Supply Unit.....	5
1.5 Paper Specifications.....	5
1.6 Take-up Device (For type A/AM)	6
1.7 Auto Cutter (For type A/AM/B).....	6
1.8 Printing Area.....	6
1.9 Receive Buffer	7
1.10 Electrical Specifications.....	7
1.11 Applicable Standards (EMC measured using Seiko Epson's AC adapter provided with the printer)	7
1.12 Reliability.....	8
1.13 Environmental Specifications, etc.....	8
1.14 Printer Installation Stance.....	9
2. CONFIGURATION	10
2.1 Interface Specifications	10
2.1.1 RS-232 serial interface	10
2.1.2 IEEE 1284 Bidirectional Parallel Interface(Parallel Interface Specifications)	15
2.2 Connectors.....	21
2.2.1 Interface connectors.....	21
2.2.2 Power supply connector	21
2.2.3 Drawer kick-out connector (modular connector)	22
3. FUNCTIONS	24
3.1 Commands	24
3.2 Character Code Tables	26
3.2.1 Page 0 (PC437: U.S.A. Standard Europe) (International character set:U.S.A.).....	26
3.2.2 Page 1 (Katakana).....	27
3.2.3 Page 2 (PC850: Multilingual).....	28
3.2.4 Page 3 (PC860: Portuguese).....	29
3.2.5 Page 4 (PC863: Canadian-French)	30
3.2.6 Page 5 (PC865: Nordic).....	31
3.2.7 Page 6 (Hiragana) (Available on Japanese Kanji model)	32
3.2.8 Page 7 (One-pass printing Kanji characters) (Available on Japanese Kanji model)	33
3.2.9 Page 8 (One-pass printing Kanji characters) (Available on Japanese Kanji model)	34
3.2.10 Page 20 (Thai character code 42).....	35
3.2.11 Page 21 (Thai character code 11).....	36
3.2.12 Page 22 (Thai character code 13).....	37
3.2.13 Page 23 (Thai character code 14).....	38
3.2.14 Page 24 (Thai character code 16).....	39
3.2.15 Page 25 (Thai character code 17).....	40
3.2.16 Page 26 (Thai character code 18).....	41
3.2.17 Page 254 (space page).....	42
3.2.18 Page 255 (space page).....	43
3.2.19 International character set	44
3.3 Switches and Buttons	45
3.3.1 Power switch.....	45
3.3.2 Panel buttons	45
3.3.3 DIP switches (For type B/D).....	45
3.3.4 DIP switches (For type A/AM).....	47
3.4 Panel LED Indicators.....	49
3.4.1 Panel LED indicators	49

EPSON	TITLE	SHEET REVISION	NO.	
	TM-U200 series Specification (STANDARD)	I	NEXT V	SHEET IV

Confidential

- 3.5 Error Processing.....49
 - 3.5.1 Error types49
 - 3.5.2 Operation when an error is detected.....50
 - 3.5.3 Data reception error50
- 3.6 Self-test51
- 3.7 Hexadecimal Dumping52
- 3.8 Paper Detectors.....53
 - 3.8.1 Detectors and LED indicators53
 - 3.8.2 Detectors and printing.....53
- 3.9 Buffer-full Printing53
- 3.10 Loading the Paper Roll53
 - 3.10.1 For type B/D53
 - 3.10.2 For type A/AM53
- 4. CASE SPECIFICATIONS54
 - 4.1 External Dimensions and Weight.....54
 - 4.2 Color.....54
 - 4.3 External Appearance.....54
- 5. ACCESSORIES AND OPTIONS.....57
 - 5.1 Standard Accessories.....57
 - 5.1.1 External appearance and weight of the AC adapter57
 - 5.2 Options.....58
 - 5.3 Interface Board.....58
- 6. Commands.....59
 - 6.1 Command Notation.....59
 - 6.2 Explanation of Terms.....59
 - 6.3 Exception Processing60
 - 6.3.1 Undefined codes.....60
 - 6.3.2 Undefined commands60
 - 6.3.3 Settings outside the defined range61
 - 6.4 Command descriptions.....62
 - HT.....62
 - LF62
 - CR63
 - DLE EOT *n*63
 - DLE ENQ *n*.....66
 - ESC SP *n*.....67
 - ESC ! *n*.....67
 - ESC % *n*.....68
 - ESC & *y c1 c2 [x1 d1...d(y × x1)]...[xk d1... d(y × xk)]*.....69
 - ESC * *m nL nH d1...dk*.....71
 - ESC – *n*72
 - ESC 273
 - ESC 3 *n*73
 - ESC <73
 - ESC = *n*.....74
 - ESC ? *n*.....75
 - ESC @.....75
 - ESC D *n1... nk NUL*.....76
 - ESC E *n*.....77
 - ESC G *n*77
 - ESC J *n*78
 - ESC K *n*.....78
 - ESC R *n*.....79
 - ESC U *n*.....80

EPSON	TITLE TM-U200 series Specification (STANDARD)	SHEET REVISION I	NO.	
			NEXT VI	SHEET V

Confidential

ESC a n	81
ESC c 3 n	82
ESC c 4 n	83
ESC c 5 n	84
ESC d n	84
ESC e n	85
ESC p m t1 t2	85
ESC r n	86
ESC t n	87
ESC { n	88
GS (A pL pH n m	89
GS I n	90
① GS V m ② GS V m n	91
GS a n	92
GS r n	94
GS z 0 t1 t2	96
FS ! n	98
FS &	99
FS	100
FS 2 c1 c2 d1...dk	100
FS ? c1 c2	102
FS C n	102
FS S n1 n2	103
FS W n	103
6.5 Ignored Commands	104
APPENDIX A: MISCELLANEOUS NOTES	App.1
APPENDIX B: INSTALLING THE NEAR-END DETECTOR AND ADJUSTING THE AMOUNT OF ROLL PAPER REMAINING	App.5
APPENDIX C: NOTES ON CHARACTER PRINTING	App.6
APPENDIX D: NOTES ON USING THE DRAWER KICK-OUT CONNECTOR	App.8
APPENDIX E: TRANSMISSION STATUS IDENTIFICATION	App.11
APPENDIX F: CONFIGURING THE SPACE PAGE	App.12

EPSON	TITLE	TM-U200 series Specification (STANDARD)	SHEET REVISION	NO.	
			I	NEXT 1	SHEET VI

I. BASIC SPECIFICATIONS

1.1 Printing Specifications

- (1) Printing method
Serial impact dot-matrix
- (2) Head wire configuration
9-pin serial configuration
- (3) Printing directions
Bi-directional printing (logical seeking)
- (4) Printing speed
Approx. 3.5 LPS (40 column, 16 cpi)
Approx. 6.4 LPS (16 column, 16 cpi)
(Excludes data transfer and processing time)
(LPS: Lines Per Second)

Note1: If the printing duty ratio is too high, the operation of the print head is stopped by the duty limit. In such circumstances, the printing speeds shown above cannot be guaranteed.

Note2: When select red-color or 2-color (black/red) combination printing, the printing speed goes down compared to black-color printing. It is caused by the switching operation in the printer.

- (5) Characters per line
Refer to Table 1.2.1.
- (6) Characters per inch
Refer to Table 1.2.1.
- (7) Printing duty ratio
Refer to Appendix A.
- (8) Two-color printing (2-color print version only):
Black and red colors are selectable.

1.2 Character Specifications

- (1) Character types
Alphanumerics (95 characters)
Graphics (128 × 8 character tables; 11 tables for TM-U200 type AM)
International characters (32 characters)
The model type AM supports printing with one of the following characters:

- ① Japanese Kanji (Two-pass printing font)
JIS (JIS X0208-1990) Level 1, Level 2
- ② Chinese Kanji (Two-pass printing font)
7580 (GB2312)
- ③ Taiwanese Kanji (Two-pass printing font)
13494 (Big 5)
- ④ Thai character (3-pass printing font)
128 characters × 7 pages (133 character types)

EPSON	TITLE TM-U200 series Specification (STANDARD)	SHEET REVISION 1	NO.	
			NEXT 2	SHEET 1

Confidential

(2) Character configuration

7 × 9

9 × 9

16 × 16 (for TM-U200 type AM)

Thai character: 7 × 27 (for TM-U200 type AM)

9 × 27 (for TM-U200 type AM)

(3) Character dimensions

Refer to Table 1.2.1 (CPL: Characters Per Line) (CPI: Characters Per Inch)

Table 1.2.1 Character Dimensions, Characters Per Inch, Characters Per Line

Character configuration		Character dimensions W x H (mm)	Dot spacing between characters	Characters per line (CPL)	Characters per inch (CPI)
Horiz. × Vert.	Character type				
7 × 9	ANK	1.2 × 3.1	3 Half-dots	40	16
	Graphics	1.7 × 3.1	0	40	16
9 × 9	ANK	1.6 × 3.1	3 Half-dots	33	13.3
	Graphics	2.0 × 3.1	0	33	13.3
7 × 9	ANK	1.2 × 3.1	2 Half-dots	42	17.8
	Graphics	1.6 × 3.1	0	42	17.8
9 × 9	ANK	1.6 × 3.1	2 Half-dots	35	14.5
	Graphics	1.9 × 3.1	0	35	14.5
16 × 16	Kanji	2.7 × 2.7	0	25	9.5
			2	22 (*1)	8.9
7 × 27	Thai characters	1.2 × 9.5	3 Half-dots	40	16
9 × 27	Thai characters	1.6 × 9.5	3 Half-dots	33	13.3
7 × 27	Thai characters	1.2 × 9.5	2 Half-dots	42	17.8
9 × 27	Thai characters	1.6 × 9.5	2 Half-dots	35	14.5

(*1): Changeable by a software command (Default value is 22.)

Note: The default font is 7 × 9, the dot spacing between characters for 3 half-dots or 2 half-dots can be set by changing the DIP switch settings.

Example: 7 × 9 font (with three-dot spacing)

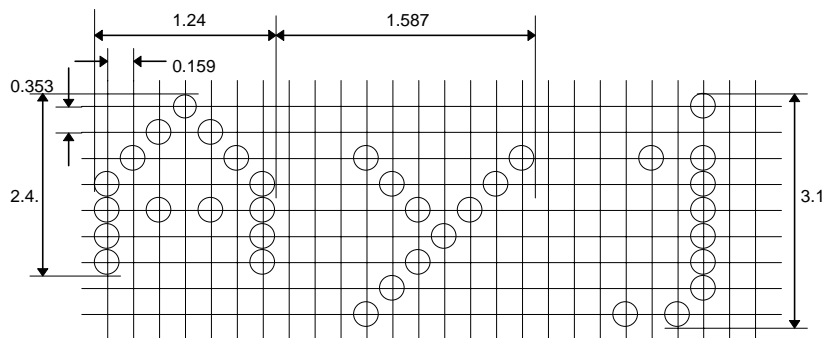

[Unit: mm]

Figure. 1.2.1 7 × 9 Font

EPSON	TITLE	TM-U200 series Specification (STANDARD)	SHEET REVISION	NO.	
			I	NEXT 3	SHEET 2

1.3 Ribbon Cassette

(1) Special ribbon cassettes

Model No.	Color	Ribbon life (*1)
ERC-38 (P)	Purple	4 million characters (under continuous printing at 25°C)
ERC-38 (B)	Black	3 million characters (under continuous printing at 25°C)
ERC-38(B/R)	Black/Red	Black: 1.5 million characters (under continuous printing at 25°C) Red: 750,000 characters (under continuous printing at 25°C)

*1: The ribbon life is based on the following conditions:

- Character font: 7 x 9 font (with descenders)
- Printing pattern: ASCII 96-character rolling pattern

Refer to the printing example for the printing pattern (Appendix Figure A-1 for ERC-38(P)/(B), Figure A-2 for ERC-38(B/R).)
25°C

(2) External view of ribbon cassette:

Refer to Figure. 1.3.1.

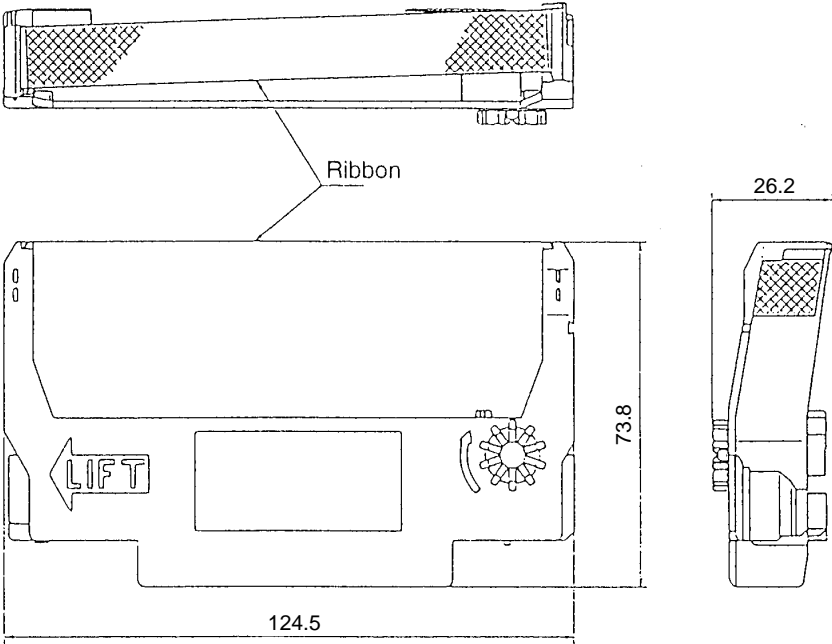

[Unit: mm]

Figure 1.3.1 External View of ERC-38 (P)/(B)

EPSON	TITLE	TM-U200 series Specification (STANDARD)	SHEET REVISION	NO.	
			I	NEXT 4	SHEET 3

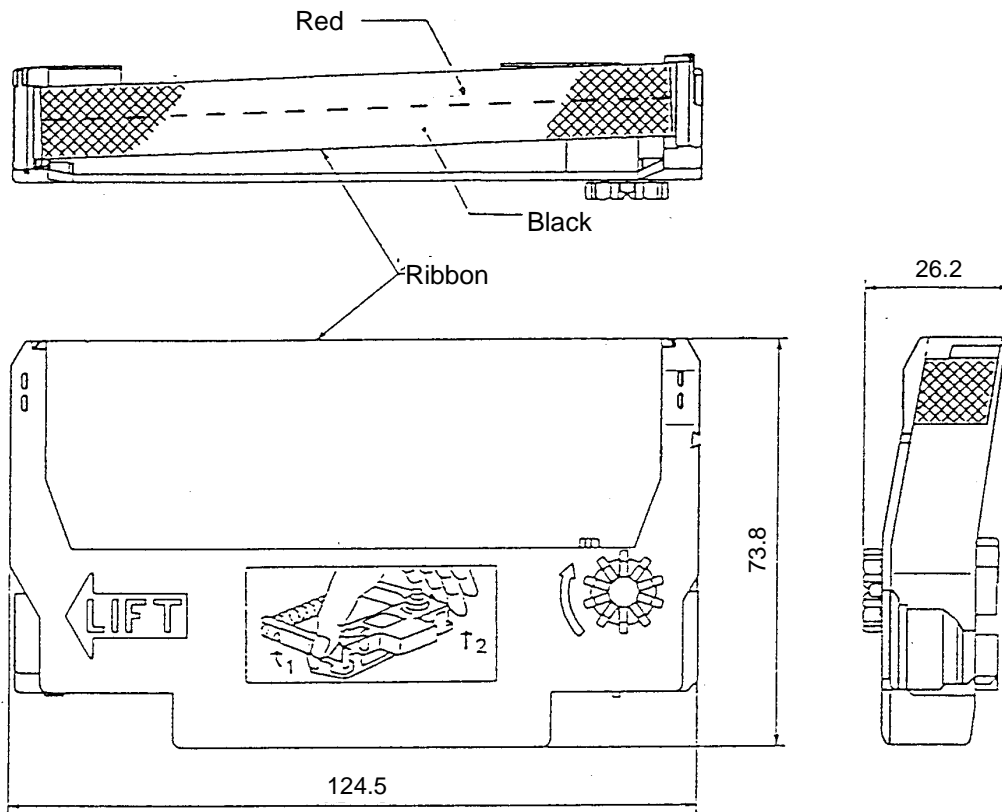

Figure 1.3.2 External view of ERC-38(B/R)

Note: Malfunctions and other problems may arise if other than the specified ribbon cassette is used. Seiko Epson does not warrant against problems arising from the use of other than the specified ribbon cassette .

EPSON	TITLE	TM-U200 series Specification (STANDARD)	SHEET REVISION	NO.	
			1	NEXT 5	SHEET 4

Confidential

1.4 Roll Paper Supply Unit

- (1) Supply method
Drop-in method
- (2) End detector
 - (a) Detection method : By mechanical microswitch
 - (b) Detection position : Positioned within the paper path for the roll paper; detects near the end of the roll paper
- (3) Near end detector(Optional)
 - (a) Detection method : By mechanical microswitch
 - (b) Inner diameter of paper roll core: 10.5 to 12.5 mm (Refer to Appendix B in details)

Note: Because the standard version of this printer is not equipped with a mechanism that detects the amount of roll paper remaining (near-end detector), paper rolls in which the paper roll core and paper are attached to each other by tape or glue may jam. Because the core will jam the paper guide, preventing paper from feeding through. Make sure to detect the amount of roll paper remaining with the optional near-end detector, or confirm the end mark of the paper and change the paper with a new one when the paper is attached in the core by tape or glue is used.

1.5 Paper Specifications

- (1) Paper feeding method: Friction feed
- (2) Paper feed interval: Initial setting: 1/6 inch
Can be set in units of 1/144th of an inch by commands.
- (3) Paper feed speed: Approx. 4.17 inches/second (25 lines/second)
(during continuous feeding)
- (4) Paper dimensions
 - (a) Paper roll
 - Width 76 mm \pm 0.5 mm
 - Maximum diameter 83 mm
 - Core When there is no near-end detector, always be sure to use a paper roll where the core and the paper are not glued together
 - ①A Normal paper
 - Paper thickness 1 sheet 0.06 to 0.085 mm
 - Weight 52.3 to 64 g/m²
(45 to 55 kg/1000 sheets/1091 x 788 mm)
 - ②Pressure-sensitive paper
 - Number of copies Original 1 sheet + up to two copy sheets (For type D only)
Original 1 sheet + one copy sheet
 - Thickness 0.05 to 0.08 mm (thickness of one sheet); combined, total thickness must be 0.2 mm or less
 - Recommended paper Paper by Mitsubishi - Carbonless paper (blue)
 - Top and middle sheets N40Hi (paper thickness: 0.06 mm, weight: 47.2 g/m²)
 - Bottom sheet N60 (paper thickness: 0.08 mm, weight: 68.0 g/m²)

EPSON	TITLE TM-U200 series Specification (STANDARD)	SHEET REVISION I	NO.	
			NEXT 6	SHEET 5

Confidential

Note : When one original and two copies (a total of three sheets) are used in an operating environment of 34°C and 90% humidity, the paper roll and may slightly curl.

(b) Copying capability

The copying capability is affected by the ambient temperature, and is guaranteed for the temperature ranges shown in the table below.

Number of copies	Guaranteed temperature range	Affected model type
Original + two copies	10° ~ 40°C	Type D
Original + one copy	5° ~ 50°C	Type A/AM/B/D

1.6 Take-up Device (For type A/AM)

A take-up device automatically takes the paper roll up in connection with a paper feed motor.

1.7 Auto Cutoff (For type A/AM/B)

Partial cut is executed by command.
 Partial cut: Cutting with one point left uncut

1.8 Printing Area

(1) Roll paper

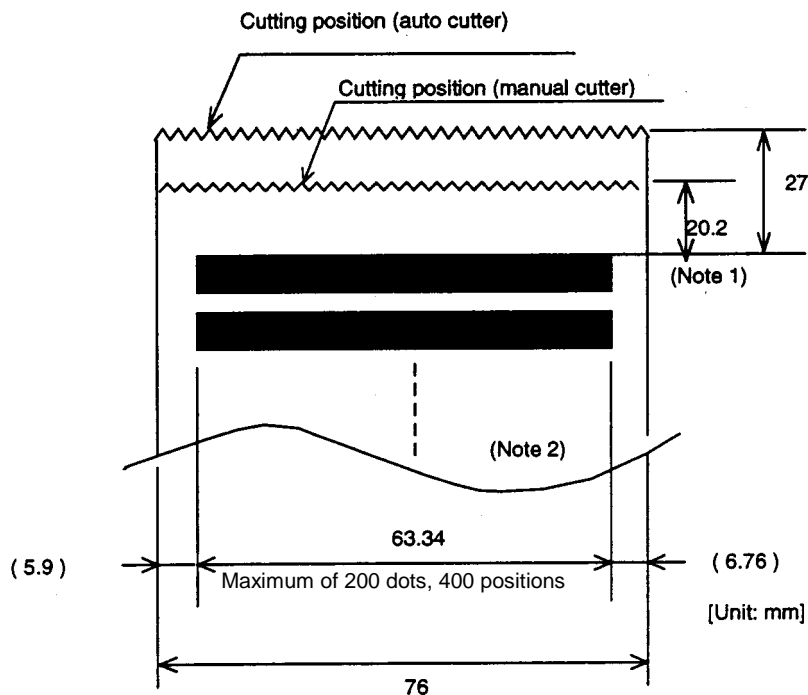

Figure 1.8.1 Printing Area

Note 1: This dimension shows the distance from the manual cutter to the printing position.

Note 2: The values shown for the printing area are the values calculated (between dot centers) according to the wire diameter (0.29 mm).

EPSON	TITLE	TM-U200 series Specification (STANDARD)	SHEET REVISION	NO.	
			I	NEXT 7	SHEET 6

Confidential

1.9 Receive Buffer

Either approximately 1 KB or 40 bytes can be selected by DIP switch. (for all model types except type AM)

Either 512 KB or 40 bytes can be selected by DIP switch. (for type AM)

1.10 Electrical Specifications

(1) Operation power supply

AC adapter included.

Select one of the following five types, depending on the specifications.

Settings and Shipment	Input Voltage range	Model Name
Japan	100V \pm 10% 50/60 Hz	PA-6508
North America	120V \pm 10% 60 Hz	PB-6509
Europe (Germany)	230V \pm 10% 50 Hz	PB-6510
Europe (U.K)	230V \pm 10% 50 Hz	PA-6511
Australia	240V \pm 10% 50 Hz	PA-6513

(2) Printer power consumption (except for during drawer-kick operation)

While operating 43 W avg.

While in standby 6 W avg.

1.11 Applicable Standards (EMC measured using Seiko Epson's AC adapter provided with the printer)

(1) Europe: CE marking

(EN55022
EN50082-1
EN45501

Safety standards: TÜV

(2) North America: EMI FCC class A

Safety standards: UL1950-2TH-D3
C-UL

(3) Japan: EMI VCCI class A

(4) Oceania: EMI AS/NZS3548 class B

(5) Taiwan(R.O.C.): EMI class B

EPSON	TITLE TM-U200 series Specification (STANDARD)	SHEET REVISION I	NO.	
			NEXT 8	SHEET 7

Confidential

1.12 Reliability

- (1) Life
 - Mechanism: 7,500,000 lines
 - Print head: 150 million characters (when in the average of 2 dots/wire per character.)
(The printing pattern is based on Appendix A 1) Print Duty.)
 - Print color switching: Refer to Appendix A 1) Print Duty.
 - Auto cutter: 800,000 cuts
 - End of life is defined as the point at which the printer reaches the beginning of the Wearout Period. Recommended paper must be used.
- (2) MTBF: 180,000 hours
Failure is defined as Random Failure occurring at the time of the Random Failure Period.
- (3) MCBF: 18,000,000 lines
This is an average failure interval based on failures relating to wearout and random failures up to the life of 7.5 million lines.

1.13 Environmental Specifications, etc.

- (1) Temperature
 - During operation: 0 to 50°C (at 34°C or higher, there are humidity restrictions; refer to Figure 1.13.1.)
 - During storage: -10 to 50°C (excludes paper and ribbon)
- (2) Humidity
 - During operation: 10 to 90% (no condensation)
 - During storage: 10 to 90% (no condensation; excludes paper and ribbon)

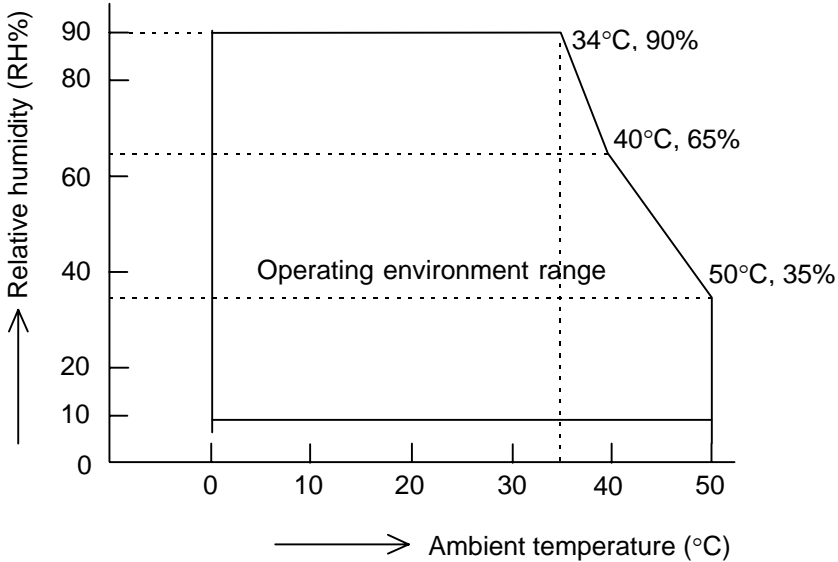

Figure 1.13.1 Operating Temperature and Humidity Range

EPSON	TITLE	TM-U200 series Specification (STANDARD)	SHEET REVISION	NO.	
			I	NEXT 9	SHEET 8

Confidential

(3) Vibration resistance

While packed:	Frequency	5 to 55 Hz
	Acceleration	2 G
	Sweep	10 minutes (half cycle)
	Time	One hour
	Directions	X, Y and Z

(4) Impact resistance

While packed:	Packaging:	Epson's standard packaging
	Height	60 cm
	Directions	1 corner, 3 edges, 6 sides

While not packed:	Height:	5 cm
	Directions	4 sides, supported on one side

1.14 Printer Installation Stance

Install the printer horizontally. Make sure that it does not tilt more than 15°.

The printer must also be installed so that it does not move or vibrate during paper cutting or the drawer kick-out operation.

Fastening tape is available as an option.

EPSON	TITLE TM-U200 series Specification (STANDARD)	SHEET REVISION I	NO.	
			NEXT 10	SHEET 9

2. CONFIGURATION

2.1 Interface Specifications

2.1.1 RS-232 serial interface

2.1.1.1 Specifications

Data transmission:	Serial
Synchronization:	Asynchronous
Handshaking:	DTR/DSR or XON/XOFF control
Signal levels:	MARK = -3 to -15 V ... logic '1' / OFF SPACE = +3 to +15 V ... logic '0' / ON
Baud rate:	4800, 9600 bps
Data word length:	7 or 8 bits
Parity:	None, even, odd
Stop bits:	1 or more (Data transmitted from the printer has 1 stop bit (fixed))
Connector:	D-SUB 25 (female) or equivalent

2.1.1.2 On-line/Off-line switching

The printer does not have an on-line/off-line button. The printer goes on-line or off-line under the following conditions:

<Conditions to go off-line>

- 1) Between the time when the power is turned on(including reset using the interface) and when the printer is ready to receive data.
- 2) During the self-test.
- 3) During paper feeding using the FEED button.
- 4) Between the time when the printer stops printing due to a paper-end and when the on-line recovery wait time finishes after loading paper.
- 5) When an error has occurred.

<Conditions to go on-line>

- 1) Automatically after the time when the power is turned on (including reset using the interface) when the printer is ready to receive data.
- 2) Automatically after the self-test.
- 3) Automatically after the paper feeding is stopped releasing the FEED button.
- 4) The time when the paper loading is completed, using **GS z 0** command. The operation differs on each model type.

For type B/D: (default: $t2=0$)

After the time when the FEED button is pressed while the PAPER OUT LED is blinking after the paper loading is completed.

For type A/AM: (default: $t2=1$)

Automatically the time when 0.5 seconds passed after the paper loading is completed.

EPSON	TITLE	SHEET REVISION	NO.	
	TM-U200 series Specification (STANDARD)	I	NEXT 11	SHEET 10

2.1.1.3 Interface connector terminal assignments and signal functions

Table 2.1.1 Interface Pin Assignments and Functions

Pin No.	Signal Name	Signal Direction	Function
1	FG	–	Frame ground
2	TXD	Output	Transmit data
3	RXD	Input	Receive data
4	RTS	Output	Same as DTR signal (same as pin 20)
6	DSR	Input	Indicates whether the host can receive data. SPACE indicates that the host can receive data, and MARK indicates that the host cannot receive data. When DTR/DSR control is selected, the printer transmits data after checking this signal (except when data is sent by DLE EOT, GS a). When XON/XOFF control is selected, the printer does not check this signal. Changing the DIP switch setting enables this signal to be used as a reset signal for the printer. The printer is reset when the signal remains MARK for 1 ms or more.
7	SG	–	Signal ground
20	DTR	Output	1) When DTR/DSR control is selected, this signal indicates whether the printer is BUSY. SPACE indicates that the printer is READY to receive data, and MARK indicates that the printer is BUSY. DIP switch 1-8 switches conditions for BUSY. The BUSY (MARK) condition is changed using DIP switch 1-8 as follows:
25	Printer Status		Dip Switch 1-8 Status
			ON OFF
	Off-line	1) The period from power-on (or initialization of the mechanism due to resetting through the interface) until the printer is ready to receive data.	BUSY BUSY
		2) During the self-test	BUSY BUSY
		3) During paper feeding using the FEED button	---- BUSY
		4) When the printer stops due to a paper-end(ESC c 4).	---- BUSY
		5) During an error condition	---- BUSY
	6) When the receive buffer is full. (*1)	BUSY BUSY	
		2) When XON/XOFF control is selected, this signal indicates whether the printer is properly connected and is ready to receive data. SPACE indicates that the printer is properly connected and is ready to receive data. This signal is always SPACE except during the following periods: <ul style="list-style-type: none"> • From power-on until the printer is ready to receive data. • During the self-test. 	
	INIT	Output	Changing the DIP switch setting enables this signal to be used as a reset signal for the printer. The printer is reset when the signal remains SPACE for 1 ms or more.

EPSON	TITLE	TM-U200 series Specification (STANDARD)	SHEET REVISION	NO.	
			I	NEXT 12	SHEET 11

Confidential

- *1 • The period from when the remaining space in the receive buffer drops to 16 bytes until it increases to 32 bytes is called the “buffer full state”.
- Data received when the remaining space in the receive buffer is zero bytes is ignored.

2.1.1.4 XON/OFF transmit timing

When XON/OFF control is selected, the printer transmits XON or XOFF signals as follows. Transmit timing depends on the setting of DIP switch 1-8

Table 2.1.2 XON/XOFF Transmit Timing

Printer Status		Dip Switch 1-8 Status	
		ON	OFF
[XON transmission]	1) When the printer first becomes on-line after power-on or after resetting through the interface.	Transmission	Transmission
	2) When the receive buffer is released from the buffer-full state.	Transmission	Transmission
	3) When the printer status changes from off-line to on-line.	----	Transmission
	4) When the printer recovers from an error through a command.	----	Transmission
[XOFF transmission]	5) When the receive buffer is full.	Transmission	Transmission
	6) When the printer status changes from on-line to off-line.	----	Transmission

- NOTES:
- The XON code is <11>H and the XOFF code is <13>H.
 - In case 3), XON is not transmitted when the receive buffer is full.
 - In case 6), XOFF is not transmitted when the receive buffer is full.

2.1.1.5 Example serial interface connection

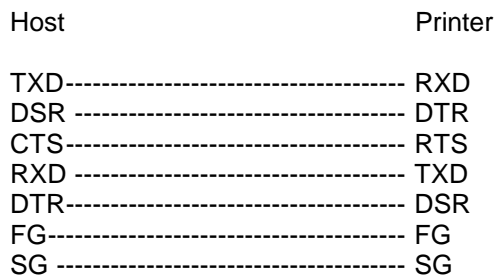

- When connecting the printer to a DCE(DCE: Data Circuit Terminating Equipment), set the handshaking so that the transmit data can be received.
- Transmit data to the printer after turning on the power and initializing the printer.

EPSON	TITLE	SHEET REVISION	NO.	
	TM-U200 series Specification (STANDARD)	I	NEXT 13	SHEET 12

2.1.1.6 Notes on setting DIP switch 1-8 to on

(1) The printer mechanism stops but does not become BUSY in the following cases:

- When an error occurs.
- When the printer stops printing due to a paper-end.
- When paper is fed using the feed button.

(2) When handshaking with the printer while using this switch setting, make sure to monitor the printer with the **GS a** command and the ASB function.

With this switch setting, the default value of the **GS a** command *n* is 2. This automatically transmits the printer status, depending on on-line/off-line changes.

(3) When using the **DLE EOT** or **DLE ENQ** command, make sure that the receive buffer does not become full.

- Notes on using a host that cannot transmit data when the printer is BUSY:
If an error occurs when the receive buffer is full and the printer is BUSY, the **DLE EOT** and **DLE ENQ** commands cannot be used.
- Notes on using a host that can transmit data when the printer is BUSY:
If a **DLE EOT** or **DLE ENQ** command is used while sending bit-image data, and the receive buffer-full state is encountered during transmission of the data, the **DLE EOT** or **DLE ENQ** is processed as bit-image data.
In addition, the data transmitted during the receive buffer-full state may be lost.

Example of use:

Set the receive buffer to 1K bytes, and check the status with **GS r** for each line of printing transmitted. Make sure that the data for printing each line does not cause the printer to enter the receive buffer-full state.

2.1.1.7 Notes on resetting the printer using the interface

The printer can be reset through the interface (pins 6 or 25) by changing the DIP switch settings accordingly (Refer to Table 3.3.3).

Table 2.1.3 Switching of the Reset Condition

Model type	Pin No.	DIP Switch	Reset Condition
B/D	Pin 6 (DSR)	DSW 2-3: ON	MARK input
	Pin 25 (INIT)	DSW 2-4: ON	SPACE or TTL-HIGH level voltage signal input
A/AM	Pin 6 (DSR)	DSW2-7: ON	MARK input
	Pin 25 (INIT)	DSW2-8: ON	SPACE or TTL-HIGH level voltage signal input

To reset the printer, the conditions given below must be satisfied:

<DC characteristics>

Table 2.1.4 DC Characteristics of the Reset Condition

Item	Symbol	Pin 6 (DSR)	Pin 25 (INIT)
Input HIGH level voltage	V IH	+3 to +15 V	+2 to + 15 V
Input LOW level voltage	V IL	-15 to -3 V	-15 to + 0.8 V
Input HIGH level current	I IH	5 mA (maximum)	1 mA (maximum)
Input LOW level current	I IL	-5.3 mA (maximum)	-2 mA (maximum)
Input impedance	RIN	3 K Ω (minimum)	

EPSON	TITLE	TM-U200 series Specification (STANDARD)	SHEET REVISION	NO.	
			I	NEXT 14	SHEET 13

<AC characteristics>

Reset minimum pulse width: TRS 1 msec (minimum)

- When Pin 6 (DSR) is used (For type B/D, DSW2-3: ON; For type A/AM, DSW2-7: ON):

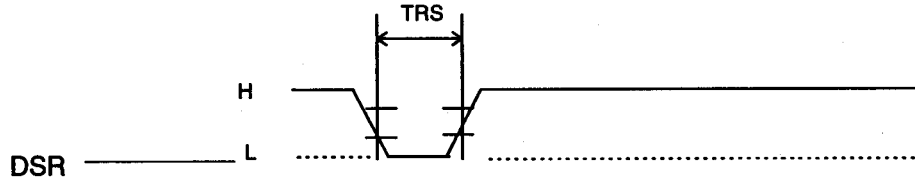

Figure 2.1.1 Interface Reset Signal (Pin 6)

- When Pin 25 (INIT) is used (For type B/D, DSW2-4: ON; For type A/AM, DSW2-8: ON):

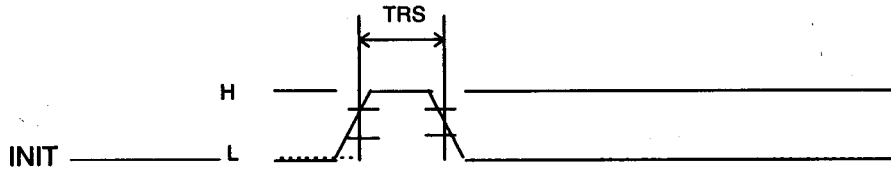

Figure 2.1.2 Interface Reset Signal (Pin 25)

- NOTES:
1. Correct printer operation is not guaranteed unless the signals meet the above stated conditions. The above conditions must also be met when TTL signals are used to drive the DSR and INIT reset pins. Although a signal is input to Pin 6 (DSR) at the TTL level, according to the DC characteristics described above, the operation is not guaranteed and Pin 6 cannot be controlled.
 2. When Pin 6 (DSR) and Pin 25 (INIT) are open, the printer is operating.

EPSON	TITLE	TM-U200 series Specification (STANDARD)	SHEET REVISION	NO.	
			I	NEXT 15	SHEET 14

2.1.2 IEEE 1284 Bidirectional Parallel Interface(Parallel Interface Specifications)
 Copyright (C) 1993 by the Institute of Electrical and Electronic Engineers, Inc.

2.1.2.1 Specifications

Data transmission:	8-bit Parallel
Synchronization:	Externally supplied nStrobe signals
Handshaking:	nAck and Busy signals
Signal levels:	TTL compatible
Connector:	57RE-40360-830B (DDK) or equivalent (IEEE 1284 Type B)

Reverse communication (Printer Host): Nibble or Byte Mode

2.1.2.2 Switching between on-line and off-line

The printer is not equipped with any on-line/off-line switch. The printer is placed into off-line status in either of the followings:

- When the power is turned on or until the printer becomes ready for data transmission after it is initialized by the reset signal (nInit) from the interface.
- In the process of self-test.
- In the process of paper feeding using the paper feed switch
- Between the time when the printer stops printing due to a paper-end and when the on-line recovery wait time finishes after loading paper. (in cases when empty paper supply is detected by either the paper roll end detector or the paper roll near-end detector with a printing halt feature set enabled due to paper shortage by **ESC c 4**).
- When an error has occurred.

2.1.2.3 Reverse Mode (Data Transmission from Printer to Host)

The STATUS data transmission from the printer to the host is proceeded in the Nibble or Byte mode.

- Description
 This mode allows data transmission from the asynchronous printer under the control of the host.
 Data transmissions in the Nibble Mode are made via the existing control lines in units of four bits (Nibble). In the Byte Mode, data transmissions are proceeded by making the eight-bits data lines bidirectional.
 The both modes fail to be proceeded concurrently with the Compatibility Mode, thereby causing half duplex transmission.

EPSON	TITLE	TM-U200 series Specification (STANDARD)	SHEET REVISION	NO.	
			I	NEXT 16	SHEET 15

2.1.2.4 Interface Pin Assignments for Each Mode

Pin	Source	Compatibility Mode	Nibble Mode	Byte Mode
1	Host	nStrobe	HostClk	HostClk
2	Host/Ptr	Data0(LSB)	Data0(LSB)	Data0(LSB)
3	Host/Ptr	Data1	Data1	Data1
4	Host/Ptr	Data2	Data2	Data2
5	Host/Ptr	Data3	Data3	Data3
6	Host/Ptr	Data4	Data4	Data4
7	Host/Ptr	Data5	Data5	Data5
8	Host/Ptr	Data6	Data6	Data6
9	Host/Ptr	Data7(MSB)	Data7(MSB)	Data7(MSB)
10	Printer	nAck	PtrClk	PtrClk
11	Printer	Busy	PtrBusy/Data3, 7	PtrBusy
12	Printer	PError	AckDataReq/Data2, 6	AckDataReq
13	Printer	Select	Xflag/Data1, 5	Xflag
14	Hostr	nAutoFd	HostBusy	HostBusy
15		NC	ND	ND
16		GND	GND	GND
17		FG	FG	FG
18	Printer	Logic-H	Logic-H	Logic-H
19		GND	GND	GND
20		GND	GND	GND
21		GND	GND	GND
22		GND	GND	GND
23		GND	GND	GND
24		GND	GND	GND
25		GND	GND	GND
26		GND	GND	GND
27		GND	GND	GND
28		GND	GND	GND
29		GND	GND	GND
30		GND	GND	GND
31	Host	nInit	nInit	nInit
32	Printer	nFault	nDataAvail/Data0, 4	nDataAvail
33		GND	ND	ND
34	Printer	DK_STATUS	ND	ND
35	Printer	+5V	ND	ND
36	Host	nSelectIn	1284-Active	1284-Active

EPSON	TITLE	TM-U200 series Specification (STANDARD)	SHEET REVISION	NO.	
			I	NEXT 17	SHEET 16

- NOTES:
1. A prefix “n” to signal names refers to “L” active signals. To the host provided with none of the signal lines listed above, both-way communication fails.
 2. For interfacing, signal lines shall use twisted pair cables with the return sides connected to signal ground level.
 3. Interfacing conditions shall be all based on the TTL level to meet the characteristics described below. In addition, both rise time and fall time of each signal shall be 0.5Js or less.
 4. Data transmission shall not ignore the signal nAck or Busy. An attempt to transmit data with either signal, nAck or Busy, ignored can cause lost data. (Data transmissions to the printer shall be made after verifying the nAck signal or while the Busy signal is at the “L” level.)
 5. Interface cables shall be as minimum required short in length as possible.
- *NC: No Connect
ND: Not Defined

2.1.2.5 Electrical Characteristics

DC Characteristics (Except Logic-H, +5 V signals)

Characteristics	Symbol	Specifications		Conditions
		Min	Max	
Output HIGH voltage	VOH	*2.4 V	5.5 V	*IOH=0.32mA
Output LOW voltage	VOL	-0.5 V	*0.4 V	*IOL=-12mA
Output HIGH current	IOH	0.32 V	-	VOH=0.32V
Output LOW current	IOL	-12 V	-	VOL=0.4V
Input HIGH voltage	VIH	2.0 V	-	
Input LOW voltage	VIL	-	0.8 V	
Input HIGH current	VIH	-	-0.32 mA	VIH=2.0V
Input LOW current	VIL	-	12 mA	VIL=0.8V

Logic-H Signal Sender Characteristics

Characteristics	Symbol	Specifications		Conditions
		Min	Max	
Output HIGH voltage	VOH	3.0 V	5.5 V	
Output LOW voltage	VOL	-	2.0 V	While the power is OFF

EPSON	TITLE	TM-U200 series Specification (STANDARD)	SHEET REVISION	NO.	
			I	NEXT 18	SHEET 17

+5 V Signal Sender Characteristics

Characteristics	Symbol	Specifications		Conditions
		Min	Max	
Output HIGH voltage	V _{OH}	*2.4 V	5.5 V	*I _{OH} =0.32mA
Output LOW voltage	V _{OL}	-	- **	While the power is OFF
Output HIGH current	I _{OH}	-	0.32 mA	V _{OH} =2.4V
Output LOW current	I _{OL}	- **	-	While the power is OFF

** No guarantee is offered to V_{OL} and I_{OL} while the power is OFF.

2.1.2.6 Data Receiving Timing (Compatibility Mode)

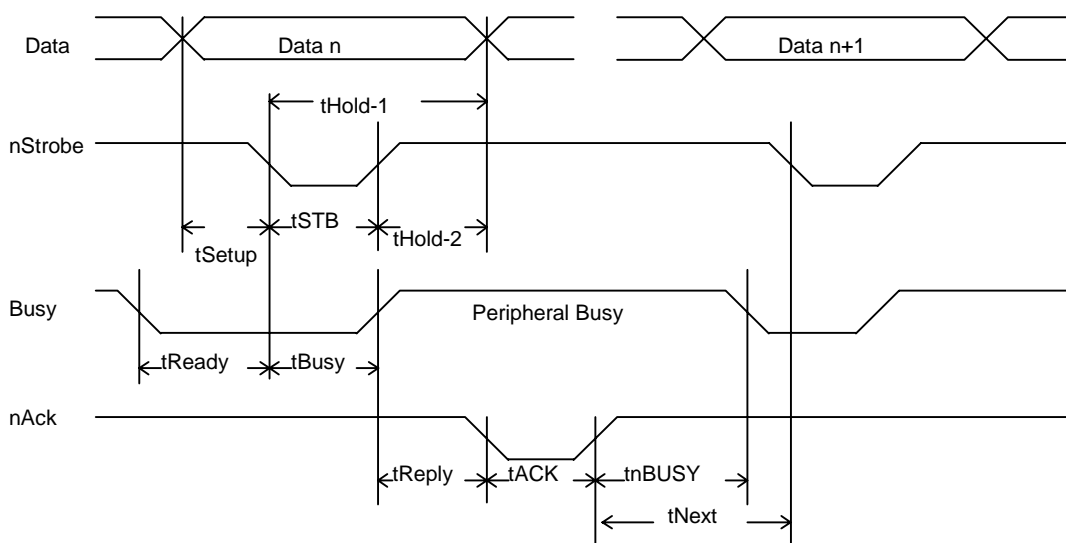

Characteristics	Symbol	Specifications	
		Min[ns]	Max[ns]
Data Hold Time (host)	tHold-1	--	500
Data Hold Time (printer)	tHold-2	--	--
Data Setup Time	tSetup	--	500
STROBE Pulse Width	tSTB	--	500
READY Cycle Idle Time	tReady	--	--
BUSY Output Delay Time	tBUSY	0	500
Data Processing Time	tReply	0	∞
ACKNLG Pulse Width	tACK	500	10μs
BUSY Release Time	tnBUSY	0	∞
ACK Cycle Idle Time	tNEXT	--	0

*The printer latches data at a nStrobe ↓ timing

2.1.2.7 Notes on resetting the printer through the interface

The printer reset is available through the interface nInit signal (pin 31) by changing the DIP switch setting. (Refer to Table 3.3.5 DIP Switch 2.)

Table 2.1.5 DIP Switch Setting for Printer Reset

Model type	Signal Line	DIP Switch	Reset Condition
B/D	Pin 31 (nInit)	DSW 2-4: ON	TTL-LOW level input
A/AM	Pin 31 (nInt)	DSW 2-8: ON	TTL-LOW level input

The printer reset through the nInit signal is only available with the SelectIn(1284-Active) signal at LOW.

To enable the printer reset, the following signal timing shall be satisfied.

Minimum reset pulse width TR: 50µs (min)

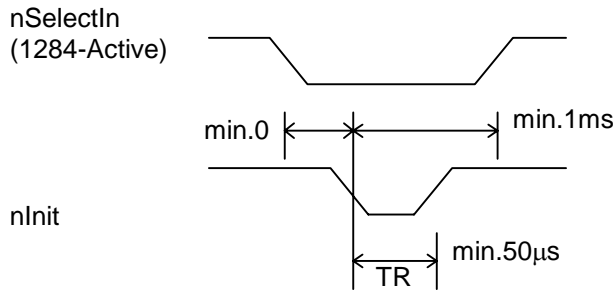

2.1.2.8 Notes on setting DIP switch 1-8 to ON

- 1) The printer mechanism stops but does not become busy when: an error has occurred, printing stops due to a paper-end, or paper is fed using the paper feed switch.
- 2) When setting DIP switch 2-5 to ON to enable handshaking with the printer, be sure to check the printer status using the **GS a** command and the ASB function. In this setting, the default value of n for **GS a** is 2. The printer automatically transmits the printer status, depending on on-line/off-line changes.
- 3) When using **DLE EOT** and **DLE ENQ** be sure that the receive buffer does not become full.
 - When using a host that cannot transmit data when the printer is busy:
If an error has occurred, **DLE EOT** and **DLE ENQ** cannot be used when the printer is busy due to a receive buffer-full state.
 - When using a host that can transmit data when the printer is busy:
When the receive buffer becomes full while transmitting bit-image data, **DLE EOT** or **DLE ENQ** used while sending the bit-image data is processed as bit-image data. The data transmitted when the receive buffer is full may be lost.
Example: Check the printer status using **GS r 1** or **GS r 49** after transmitting each line of data and use the **1K** byte (512 bytes for type AM) receive buffer. Transmit one line of data so that the receive buffer does not become full.

EPSON	TITLE	TM-U200 series Specification (STANDARD)	SHEET REVISION	NO.	
			I	NEXT 20	SHEET 19

2.1.2.9 Reception of status from the printer through the bidirectional parallel interface

In the bidirectional parallel interface specifications, the printer status transmission is available by using the both-way communication facility in the Nibble/Byte Modes in accordance with the IEEE 1284.

In this case, different from in the RS-232 serial interface specifications, the real-time interruptions from the printer to the host are disabled and thus precautions must be taken to the followings.

- 1) Allowable capacity of the printer internal buffer is 99 bytes (except ASB status). The status signals exceeding this capacity will be discarded. To prevent possible loss of status, the host shall be ready for data acception (Reverse Mode).
- 2) When ASB is used, the host is preferably in the wait state for data acception (Reverse Idle Mode). When this state is not available, the host shall enter the Reverse Mode to always monitor the presence of data.
- 3) When ASB is used, preference shall be given to the ASB status for transmission over the other status signals. Any accumulated ASB status signals left for transmission from the last to the newest ASB status transmission shall be transmitted together at a time as one ASB status showing the presence of change, followed by the latest ASB status.

Example: In the normal (wait) state, the ASB status is configured as follows.

First Status	Second Status	Third Status	Fourth Status
0001 0000	0000 0000	0000 0000	0000 0000

When a sequence of operations are proceeded, the PAPER FEED button is pressed and released, the following pieces of data are accumulated.

	First Status	Second Status	Third Status	Fourth Status	
①	0001 0000	0000 0000	0000 0011	0000 0000	Near end detection
②	0101 1000	0000 0000	0000 0011	0000 0000	FEED button is pressed
③	0001 0000	0000 0000	0000 0011	0000 0000	FEED button is released

When the ASB status is received following this, a total of eight (8) bytes of ASB will be transmitted as follows.

Accumulated ASB (①+②+③)

	First Status	Second Status	Third Status	Fourth Status
Accumulated ASB(①+②+③)	0101 1000	0000 0000	0000 0011	0000 0000
+	First Status	Second Status	Third Status	Fourth Status
The latest ASB (③)	0001 0000	0000 0000	0000 0011	0000 0000
Fourth Status				

2.2 Connectors

2.2.1 Interface connectors

Refer to Section 2.1, interface.

(1) RS-232 serial interface specification

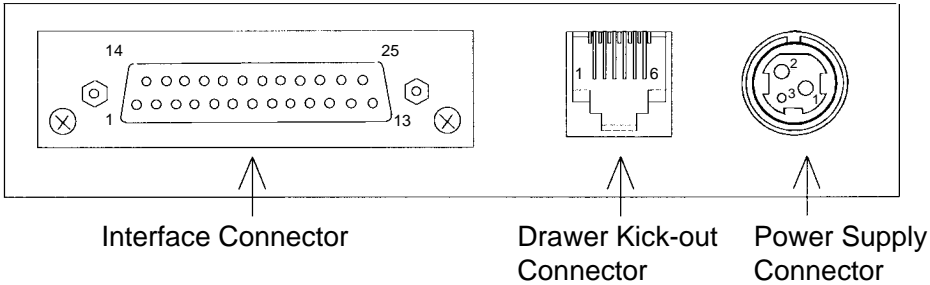

Figure 2.2.1 Connector Panel Diagram

(2) IEEE 1284 Parallel interface specification

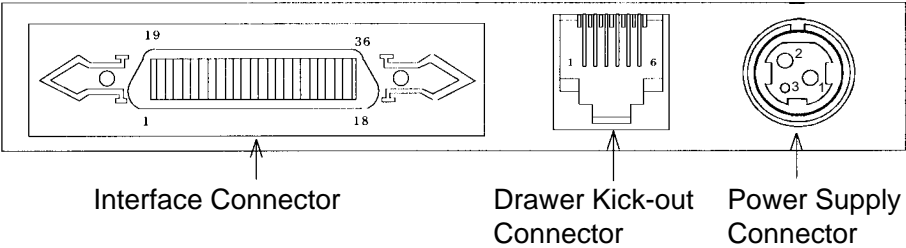

Figure 2.2.2 Connector Panel Diagram

2.2.2 Power supply connector

This connector is used to connect the printer to an external power source.

- 1) Pin assignments: Refer to Table 2.2.3.
- 2) Model (printer side): Hosiden TCS7960-532010 (or equivalent)
- 3) Model (host side): Hosiden TCP8927-631100 (or equivalent)
or TCP8927-531100 (or equivalent)

Table 2.2.1 Power Supply Connector Pin Assignments

Pin Number	Signal Name
1	+ Power source
2	GND
3	NC
Shell	FG

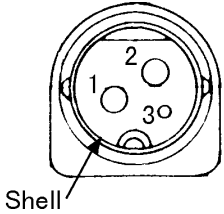

Figure 2.2.3 Power Supply Connector

NOTE: Be sure to ground the frame ground (FG) screw on the board at the bottom of the unit.

EPSON	TITLE	TM-U200 series Specification (STANDARD)	SHEET REVISION	NO.	
			I	NEXT 22	SHEET 21

2.2.3 Drawer kick-out connector (modular connector)

The signal specified by the **ESC p** command is output to this connector. The host can confirm the input signal state by using the **DLE EOT**, **GS a**, and **GS r** commands.

1) Pin assignments

Table 2.2.2 Drawer kick-out Connector Pin Assignments

Pin No.	Signal Name	Direction
1	Frame GND	--
2	Drawer kick-out drive signal 1	Output
3	Drawer open/close signal	Input
4	+24 V	--
5	Drawer kick-out drive signal 2	Output
6	Signal GND	--

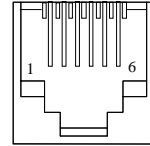

Figure 2.2.4 Drawer kick-out Connector

2) Drawer kick-out drive signal

Output signal: Voltage: Approximately 24 V
 Current: 1 A or less

CAUTION: To avoid an overcurrent, the resistance of the drawer kick-out solenoid must be 24Ω or more.

Output waveform: Outputs the waveforms in Figure 2.2.5 to points A and B in Figure 2.2.6. (The **ESC p** command specifies ON time $t1$ and OFF time $t2$.)

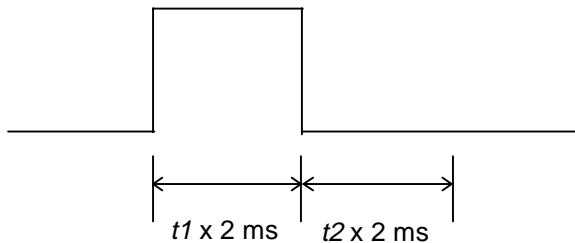
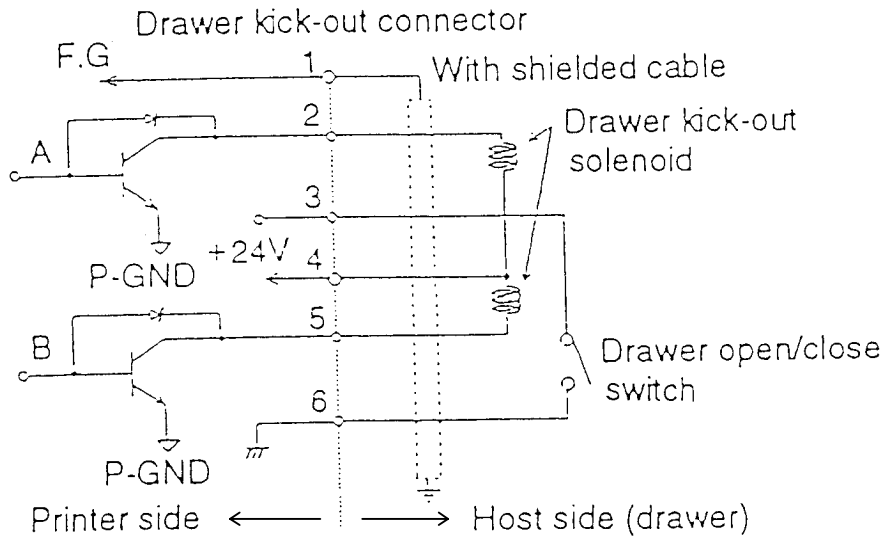

Figure 2.2.5 Drawer Kick-out Drive Signal

EPSON	TITLE	TM-U200 series Specification (STANDARD)	SHEET REVISION	NO.	
			I	NEXT 23	SHEET 22

3) Drawer open/close signal



Input signal level (connector pin 3): "L" = 0 V , "H" = 2 to 5 V

Figure 2.2.6 Drawer Circuitry

- NOTES:
1. Two driver transistors cannot be driven simultaneously.
 2. The drawer drive duty must be as shown below:

$$\frac{\text{On time}}{(\text{ON time} + \text{OFF time})} \leq 0.2$$

3. Be sure to use the printer power supply (connector pin 4) for the drawer power source.
4. The resistance of the drawer kick-out solenoid must not be less than that specified (24 Ω). Otherwise, an overcurrent could damage the solenoid.

EPSON	TITLE	TM-U200 series Specification (STANDARD)	SHEET REVISION	NO.	
			I	NEXT 24	SHEET 23

3. FUNCTIONS

3.1 Commands

1) Commands list for TM-U200 type A/AM/B/D

Command	Name	Valid command when the reception buffer capacity is 40 bytes *2	Command Classification(*1)	
			Execution Command	Setting Command
HT	Horizontal tab	○	○	
LF	Print and line feed		○	
CR	Print and carriage return		○	
DLE EOT	Real-time status transmission		○	
DLE ENQ	Real-time request to printer		○	
ESC SP	Set right-side character spacing			○
ESC !	Select print mode(s)			○
ESC %	Select/cancel down loaded character set	○		○
ESC &	Define user-defined characters	○		○
ESC *	Select bit-image mode		○	
ESC -	Turn underline mode on/off			○
ESC 2	Select default line spacing			○
ESC 3	Set line spacing			○
ESC <	Return home		○	
ESC =	Select peripheral device			○
ESC ?	Cancel user-defined character	○		○
ESC @	Initialize printer		○	○
ESC D	Set horizontal tab positions	○		○
ESC E	Turn emphasized mode on/off			○
ESC G	Turn double-strike mode on/off			○
ESC J	Feed paper and printing		○	
ESC K	Print and reverse feed		○	
ESC R	Select an international character set			○
ESC U	Turn unidirectional printing mode on/off			○
ESC a	Select justification			○
ESC c 3	Select paper sensor to output paper-end signal (Only for parallel interface model)			○
ESC c 4	Select paper sensor(s) to stop printing			○
ESC c 5	Enable/disable panel buttons			○
ESC d	Printing and feed <i>n</i> lines		○	
ESC e	Print and reverse feed <i>n</i> lines		○	
ESC p	Generate pulse		○	
ESC r	Select print color (Only for 2-color print model)			○

EPSON	TITLE	SHEET REVISION	NO.	
	TM-U200 series Specification (STANDARD)	I	NEXT 25	SHEET 24

Confidential

Command	Name	Valid command when the reception buffer capacity is 40 bytes *2	Command Classification(*1)	
			Execution Command	Setting Command
ESC t	Select character code table			○
ESC {	Turn upside-down printing mode on/off			○
GS (A	Execute test print		○	
GS l	Transmit printer ID		○	
GS V	Feed paper for cutting position		○	
GS a	Enable/disable Automatic Status Back		○	○
GS r	Transmit status		○	
GS z 0	Set on-line recovery wait time			○

*1: Commands are classified into two major parts as follows:

Execution command: Executes printer functions. Not affect following data.

Setting command: Sets the printer's operational conditions. The printer status is retained by flag, and the command affects following data.

○ marks in the table above show that the command is applicable to the execution or setting command.

*2: Commands are effective only when the space in the receive buffer is set to 40 bytes (Setting by DIP switch 1-2 on).

2) Commands list which are effective for TM-U200 type
Japanese Kanji model / Chinese Kanji model / Taiwanese Kanji model only

Command	Name	Valid command when the reception buffer capacity is 40 bytes *2	Command Classification(*1)	
			Execution Command	Setting Command
FS !	Set print mode(s) for Kanji characters			○
FS &	Select Kanji character mode			○
FS -	Turn underline mode on/off for Kanji characters			○
FS .	Cancel Kanji character mode			○
FS 2	Define user-defined Kanji characters	○		○
FS ?	Cancel user-defined Kanji characters	○		○
FS C	Select Kanji character code system			○
FS S	Set left-and right-side Kanji character spacing			○
FS W	Turn quadruple-size mode on/off for Kanji characters			○

EPSON	TITLE	SHEET REVISION	NO.	
	TM-U200 series Specification (STANDARD)	I	NEXT 26	SHEET 25

3.2 Character Code Tables

3.2.1 Page 0 (PC437: U.S.A. Standard Europe) (International character set:U.S.A.)

HEX	O	1	2	3	4	5	6	7	8	9	A	B	C	D	E	F
0000	0000	0001	0010	0011	0100	0101	0110	0111	1000	1001	1010	1011	1100	1101	1110	1111
NUL	DLE	SP		O	@	P		P	Ç	É	á	☼	┘	┘	α	≡
0001	0001	0017	0033	0049	0065	0081	0097	0113	0129	0145	í	☼	┘	┘	β	±
0010	0002	0018	0034	0050	0066	0082	0098	0114	0130	0146	ó	☼	┘	┘	Γ	Λ
0011	0003	0019	0035	0051	0067	0083	0099	0115	0131	0147	ú	☼	┘	┘	π	∇
0100	EOT	0020	0036	0052	0068	0084	0100	0116	0132	0148	ñ	☼	┘	┘	Σ	┘
0101	ENQ	0021	0037	0053	0069	0085	0101	0117	0133	0149	Ñ	☼	┘	┘	ο	┘
0110		0022	0038	0054	0070	0086	0102	0118	0134	0150	ä	☼	┘	┘	μ	÷
0111		0023	0039	0055	0071	0087	0103	0119	0135	0151	ó	☼	┘	┘	τ	≈
1000	BS	0024	0040	0056	0072	0088	0104	0120	0136	0152	ć	☼	┘	┘	φ	°
1001		0025	0041	0057	0073	0089	0105	0121	0137	0153	ı	☼	┘	┘	θ	•
1010	LF	0026	0042	0058	0074	0090	0106	0122	0138	0154	ı	☼	┘	┘	Ω	•
1011		0027	0043	0059	0075	0091	0107	0123	0139	0155	ı	☼	┘	┘	δ	√
1100	FF	0028	0044	0060	0076	0092	0108	0124	0140	0156	ı	☼	┘	┘	∞	∞
1101	CR	0029	0045	0061	0077	0093	0109	0125	0141	0157	ı	☼	┘	┘	∅	²
1110		0030	0046	0062	0078	0094	0110	0126	0142	0158	ı	☼	┘	┘	€	■
1111		0031	0047	0063	0079	0095	0111	0127	0143	0159	ı	☼	┘	┘	∩	SP

NOTE: The actual print patterns differ from those in the above character code.

<h1>EPSON</h1>	TITLE	SHEET REVISION	NO.	
	TM-U200 series Specification (STANDARD)	I	NEXT 27	SHEET 26

Confidential

3.2.2 Page 1 (Katakana)

HEX	HEX BIN	8	9	A	B	C	D	E	F
		1000	1001	1010	1011	1100	1101	1110	1111
0	0000	▬ 128	⊥ 144	SP 160	ー 176	タ 192	ミ 208	ニ 224	× 240
1	0001	▬ 129	⊥ 145	。 161	ア 177	チ 193	ム 209	ト 225	円 241
2	0010	▬ 130	⊥ 146	「 162	イ 178	ツ 194	メ 210	キ 226	年 242
3	0011	▬ 131	⊥ 147	」 163	ウ 179	テ 195	モ 211	コ 227	月 243
4	0100	■ 132	▬ 148	、 164	エ 180	ト 196	ヤ 212	▲ 228	日 244
5	0101	■ 133	▬ 149	・ 165	オ 181	ナ 197	ユ 213	▲ 229	時 245
6	0110	■ 134	150	ヲ 166	カ 182	ニ 198	ヨ 214	▼ 230	分 246
7	0111	■ 135	151	ア 167	キ 183	ヌ 199	ラ 215	▼ 231	秒 247
8	1000	136	「 152	イ 168	ク 184	ネ 200	リ 216	♠ 232	〒 248
9	1001	137	「 153	ウ 169	ケ 185	ノ 201	ル 217	♥ 233	市 249
A	1010	138	「 154	エ 170	コ 186	ハ 202	レ 218	♦ 234	区 250
B	1011	139	「 155	オ 171	サ 187	ヒ 203	ロ 219	♣ 235	町 251
C	1100	■ 140	「 156	ヤ 172	シ 188	フ 204	ワ 220	● 236	村 252
D	1101	■ 141	「 157	ユ 173	ス 189	ヘ 205	ン 221	○ 237	人 253
E	1110	■ 142	「 158	ヨ 174	セ 190	ホ 206	・ 222	/ 238	☼ 254
F	1111	⊥ 143	「 159	ツ 175	ソ 191	マ 207	・ 223	\ 239	SP 255

EPSON	TITLE	SHEET REVISION	NO.	
	TM-U200 series Specification (STANDARD)	I	NEXT 28	SHEET 27

Confidential

3.2.3 Page 2 (PC850: Multilingual)

	HEX	8	9	A	B	C	D	E	F
HEX	BIN	1000	1001	1010	1011	1100	1101	1110	1111
0	0000	Ç 128	É 144	á 160	⌘ 176	Ɔ 192	ø 208	Ó 224	— 240
1	0001	ü 129	æ 145	í 161	⌘ 177	Ɔ 193	Ð 209	β 225	± 241
2	0010	é 130	Æ 146	ó 162	⌘ 178	Ɔ 194	Ê 210	Ô 226	— 242
3	0011	â 131	ô 147	ú 163	⌘ 179	Ɔ 195	Ë 211	Ò 227	¼ 243
4	0100	ä 132	ö 148	ñ 164	⌘ 180	— 196	È 212	õ 228	¶ 244
5	0101	à 133	ò 149	Ñ 165	À 181	† 197	ı 213	Ö 229	§ 245
6	0110	â 134	û 150	ä 166	Â 182	ã 198	í 214	µ 230	÷ 246
7	0111	ç 135	ù 151	ó 167	À 183	Ã 199	î 215	þ 231	· 247
8	1000	ê 136	ÿ 152	¿ 168	© 184	Ɔ 200	ï 216	þ 232	° 248
9	1001	ë 137	ÿ 153	© 169	† 185	Ɔ 201	ı 217	Û 233	° 249
A	1010	è 138	Û 154	¬ 170	ı 186	Ɔ 202	Ɔ 218	Ô 234	· 250
B	1011	ï 139	ø 155	½ 171	Ɔ 187	Ɔ 203	■ 219	Û 235	¹ 251
C	1100	î 140	£ 156	¼ 172	Ɔ 188	Ɔ 204	■ 220	ý 236	³ 252
D	1101	ì 141	Ø 157	ı 173	Ɔ 189	— 205	ı 221	Ý 237	² 253
E	1110	Ä 142	× 158	« 174	¥ 190	Ɔ 206	î 222	238	■ 254
F	1111	Å 143	ƒ 159	» 175	Ɔ 191	Ɔ 207	■ 223	239	SP 255

EPSON	TITLE	SHEET REVISION	NO.	
	TM-U200 series Specification (STANDARD)	1	NEXT 29	SHEET 28

Confidential

3.2.4 Page 3 (PC860: Portuguese)

	HEX	8	9	A	B	C	D	E	F
HEX	BIN	1000	1001	1010	1011	1100	1101	1110	1111
0	0000	Ç 128	É 144	Á 160	⌘ 176	Ⓕ 192	Ⓖ 208	α 224	≡ 240
1	0001	ü 129	À 145	Í 161	⌘ 177	Ⓕ 193	Ⓖ 209	β 225	± 241
2	0010	é 130	È 146	Ó 162	⌘ 178	Ⓕ 194	Ⓖ 210	Γ 226	≥ 242
3	0011	â 131	ô 147	ú 163	⌘ 179	Ⓕ 195	Ⓖ 211	π 227	≤ 243
4	0100	ã 132	õ 148	ñ 164	⌘ 180	Ⓕ 196	Ⓖ 212	Σ 228	ƒ 244
5	0101	à 133	ò 149	Ñ 165	⌘ 181	Ⓕ 197	Ⓖ 213	σ 229	Ƶ 245
6	0110	Á 134	Ú 150	â 166	⌘ 182	Ⓕ 198	Ⓖ 214	μ 230	÷ 246
7	0111	ç 135	ù 151	ó 167	⌘ 183	Ⓕ 199	Ⓖ 215	τ 231	≈ 247
8	1000	ê 136	î 152	ç 168	⌘ 184	Ⓕ 200	Ⓖ 216	Φ 232	° 248
9	1001	ê 137	õ 153	ò 169	⌘ 185	Ⓕ 201	Ⓖ 217	θ 233	• 249
A	1010	è 138	Û 154	¬ 170	⌘ 186	Ⓕ 202	Ⓖ 218	Ω 234	· 250
B	1011	í 139	ϕ 155	½ 171	⌘ 187	Ⓕ 203	■ 219	δ 235	√ 251
C	1100	ô 140	£ 156	¼ 172	⌘ 188	Ⓕ 204	■ 220	∞ 236	n 252
D	1101	ì 141	Û 157	¡ 173	⌘ 189	Ⓕ 205	■ 221	∅ 237	² 253
E	1110	Ã 142	ϕ 158	« 174	⌘ 190	Ⓕ 206	■ 222	€ 238	■ 254
F	1111	Ã 143	Ó 159	» 175	⌘ 191	Ⓕ 207	■ 223	∩ 239	SP 255

EPSON	TITLE	SHEET REVISION	NO.	
	TM-U200 series Specification (STANDARD)	I	NEXT 30	SHEET 29

Confidential

3.2.5 Page 4 (PC863: Canadian-French)

	HEX	8	9	A	B	C	D	E	F
HEX	BIN	1000	1001	1010	1011	1100	1101	1110	1111
0	0000	Ç 128	É 144	Ì 160	Ï 176	Ĺ 192	Ľ 208	Ǻ 224	≡ 240
1	0001	Û 129	Ê 145	Í 161	Î 177	Ł 193	Ŧ 209	ǻ 225	± 241
2	0010	É 130	Ë 146	Ó 162	Ï 178	Ŧ 194	Ŧ 210	Γ 226	≥ 242
3	0011	Â 131	Ô 147	Ú 163	Ï 179	Ŧ 195	Ľ 211	Π 227	≤ 243
4	0100	À 132	Ë 148	Ì 164	Ï 180	Ĺ 196	Ľ 212	Σ 228	ƒ 244
5	0101	Á 133	Ï 149	Í 165	Î 181	Ł 197	Ŧ 213	σ 229	Ƶ 245
6	0110	Ŧ 134	Û 150	³ 166	Ŧ 182	Ŧ 198	Ŧ 214	μ 230	÷ 246
7	0111	Ç 135	Û 151	Ì 167	Ï 183	Ŧ 199	Ŧ 215	τ 231	≈ 247
8	1000	Ê 136	Ï 152	Î 168	Ŧ 184	Ĺ 200	Ŧ 216	Φ 232	° 248
9	1001	Ë 137	Ô 153	Ŧ 169	Ŧ 185	Ŧ 201	Ŧ 217	θ 233	• 249
A	1010	È 138	Û 154	Ŧ 170	Ï 186	Ĺ 202	Ŧ 218	Ω 234	· 250
B	1011	Ï 139	Φ 155	½ 171	Ŧ 187	Ŧ 203	■ 219	δ 235	√ 251
C	1100	Î 140	£ 156	¼ 172	Ŧ 188	Ŧ 204	■ 220	∞ 236	∞ 252
D	1101	Ŧ 141	Û 157	¾ 173	Ŧ 189	Ŧ 205	■ 221	∅ 237	² 253
E	1110	À 142	Û 158	« 174	Ŧ 190	Ŧ 206	■ 222	ε 238	■ 254
F	1111	Ŧ 143	ƒ 159	» 175	Ŧ 191	Ŧ 207	■ 223	∩ 239	SP 255

EPSON	TITLE	SHEET REVISION	NO.	
	TM-U200 series Specification (STANDARD)	I	NEXT 31	SHEET 30

Confidential

3.2.6 Page 5 (PC865: Nordic)

	HEX	8	9	A	B	C	D	E	F
HEX	BIN	1000	1001	1010	1011	1100	1101	1110	1111
0	0000	Ç 128	É 144	á 160	☒ 176	Ł 192	⊥ 208	α 224	≡ 240
1	0001	ü 129	æ 145	í 161	☒ 177	⊥ 193	⊥ 209	β 225	± 241
2	0010	é 130	Æ 146	ó 162	☒ 178	⊥ 194	⊥ 210	Γ 226	≥ 242
3	0011	ā 131	ô 147	ú 163	 179	† 195	⊥ 211	π 227	≤ 243
4	0100	ä 132	ö 148	ñ 164	† 180	- 196	⊥ 212	Σ 228	f 244
5	0101	à 133	ò 149	Ñ 165	† 181	† 197	⊥ 213	σ 229	J 245
6	0110	â 134	û 150	ä 166	† 182	† 198	⊥ 214	μ 230	÷ 246
7	0111	ç 135	ù 151	ó 167	† 183	† 199	⊥ 215	τ 231	≈ 247
8	1000	ê 136	ÿ 152	¿ 168	† 184	⊥ 200	⊥ 216	Φ 232	° 248
9	1001	ë 137	Ö 153	ƒ 169	† 185	⊥ 201	⊥ 217	Θ 233	• 249
A	1010	è 138	Û 154	ƒ 170	 186	⊥ 202	⊥ 218	Ω 234	· 250
B	1011	ï 139	ø 155	½ 171	† 187	⊥ 203	■ 219	δ 235	√ 251
C	1100	î 140	£ 156	¼ 172	⊥ 188	⊥ 204	■ 220	∞ 236	n 252
D	1101	ì 141	Ø 157	i 173	⊥ 189	- 205	■ 221	∅ 237	² 253
E	1110	Ä 142	ƒ 158	« 174	⊥ 190	⊥ 206	■ 222	€ 238	■ 254
F	1111	Å 143	f 159	¤ 175	† 191	⊥ 207	■ 223	∩ 239	SP 255

EPSON	TITLE	SHEET REVISION	NO.	
	TM-U200 series Specification (STANDARD)	I	NEXT 32	SHEET 31

Confidential

3.2.7 Page 6 (Hiragana) (Available on Japanese Kanji model)

	HEX	8	9	A	B	C	D	E	F
HEX	BIN	1000	1001	1010	1011	1100	1101	1110	1111
0	0000	礎 128	本 144	SP 160	一 176	た 192	み 208	過 224	換 240
1	0001	129	145	。 161	あ 177	ち 193	む 209	225	241
2	0010	除 130	荷 146	「 162	い 178	つ 194	め 210	足 226	攻 242
3	0011	131	147	」 163	う 179	て 195	も 211	227	243
4	0100	定 132	特 148	、 164	え 180	と 196	や 212	利 228	産 244
5	0101	133	149	・ 165	お 181	な 197	ゆ 213	229	245
6	0110	信 134	越 150	を 166	か 182	に 198	よ 214	用 230	打 246
7	0111	135	151	あ 167	き 183	ぬ 199	ら 215	231	247
8	1000	緑 136	他 152	い 168	く 184	ね 200	り 216	移 232	納 248
9	1001	137	153	う 169	け 185	の 201	る 217	233	249
A	1010	科 138	社 154	え 170	こ 186	は 202	れ 218	下 234	変 250
B	1011	139	155	お 171	さ 187	ひ 203	ろ 219	235	251
C	1100	目 140	瓶 156	や 172	し 188	ふ 204	わ 220	加 236	誂 252
D	1101	141	157	ゆ 173	す 189	へ 205	ん 221	237	253
E	1110	々 142	奉 158	よ 174	せ 190	ほ 206	ゝ 222	解 238	件 254
F	1111	143	159	っ 175	そ 191	ま 207	・ 223	239	255

EPSON	TITLE	SHEET REVISION	NO.	
	TM-U200 series Specification (STANDARD)	I	NEXT 33	SHEET 32

Confidential

3.2.8 Page 7 (One-pass printing Kanji characters) (Available on Japanese Kanji model)

	HEX	8	9	A	B	C	D	E	F
HEX	BIN	1000	1001	1010	1011	1100	1101	1110	1111
0	0000	日 128	会 144	水 160	受 176	点 192	課 208	買 224	非 240
1	0001	129	145	161	177	193	209	225	241
2	0010	扱 130	客 146	木 162	前 178	中 194	証 210	号 226	承 242
3	0011	131	147	163	179	195	211	227	243
4	0100	外 132	券 148	土 164	残 180	内 196	組 212	有 228	送 244
5	0101	133	149	165	181	197	213	229	245
6	0110	額 134	回 150	振 166	止 182	部 198	店 214	期 230	一 246
7	0111	135	151	167	183	199	215	231	247
8	1000	割 136	在 152	数 168	純 184	別 200	認 216	限 232	棄 248
9	1001	137	153	169	185	201	217	233	249
A	1010	検 138	算 154	精 170	替 186	戻 202	廃 218	頭 234	累 250
B	1011	139	155	171	187	203	219	235	251
C	1100	高 140	上 156	銭 172	代 188	門 204	両 220	差 236	違 252
D	1101	141	157	173	189	205	221	237	253
E	1110	価 142	火 158	総 174	値 190	料 206	効 222	括 238	番 254
F	1111	143	159	175	191	207	223	239	255

EPSON	TITLE	TM-U200 series Specification (STANDARD)	SHEET REVISION	NO.	
	I		NEXT 34	SHEET 33	

Confidential

3.2.9 Page 8 (One-pass printing Kanji characters) (Available on Japanese Kanji model)

	HEX	8	9	A	B	C	D	E	F
HEX	BIN	1000	1001	1010	1011	1100	1101	1110	1111
0	0000	訂 128	計 144	払 160	売 176	名 192	次 208	万 224	室 240
1	0001	129	145	161	177	193	209	225	241
2	0010	正 130	小 146	掛 162	取 178	個 194	不 210	責 226	商 242
3	0011	131	147	163	179	195	211	227	243
4	0100	品 132	金 148	入 164	係 180	領 196	枚 212	終 228	人 244
5	0101	133	149	165	181	197	213	229	245
6	0110	円 134	現 150	貸 166	未 182	収 198	誤 214	了 230	大 246
7	0111	135	151	167	183	199	215	231	247
8	1000	種 136	釣 152	出 168	消 184	予 200	休 216	免 232	安 248
9	1001	137	153	169	185	201	217	233	249
A	1010	担 138	預 154	支 170	費 186	約 202	契 218	伝 234	仕 250
B	1011	139	155	171	187	203	219	235	251
C	1100	当 140	税 156	単 172	年 188	込 204	開 220	自 236	控 252
D	1101	141	157	173	189	205	221	237	253
E	1110	合 142	引 158	返 174	月 190	明 206	閉 222	設 238	基 254
F	1111	143	159	175	191	207	223	239	255

EPSON	TITLE	TM-U200 series Specification (STANDARD)	SHEET REVISION	NO.	
			I	NEXT 35	SHEET 34

3.2.10 Page 20 (Thai character code 42)

	8	9	A	B	C	D	E	F
0	ร	๐		ฌ	ย	ไ	.	D3
1	๗	๑	ก	ฌ	ร	แ	๖	D+
2	๕	๒	บ	ด	ถ	โ	๗	D๑
3	๔	๓	ค	ต	ล	ใ	+	D-
4		๔	ฆ	ถ	ว	ไ	๘	D๕
5	-	๕	ง	ท	ศ	๗	.	D3
6	๒	๖	จ	ช	ษ	๗	๐	D+
7	๒	๓	ฉ	น	ส	๐	๐๕	D-
8	๒	๘	ช	บ	ห	๕	๐๖	D๕
9	๒	๙	ช	บ	ฬ	๒	๐+	D3
A	๒	๒	ข	ผ	ผ	๒	๕-	D+
B	■	ค	ฉ	ผ	ช	๒	๕๕	D-
C	←	๓	ฉ	ฬ	๕	๒	๕๖	D๕
D	↑	๓	ฉ	ฬ	๓	๕	๕+	D3
E	→	๓	ฉ	ฬ	๓	๐	D-	D+
F	↓	๕	ท	ม	๗	๘	D๕	

EPSON	TITLE	SHEET REVISION	NO.	
	TM-U200 series Specification (STANDARD)	1	NEXT 36	SHEET 35

Confidential

3.2.11 Page 21 (Thai character code 11)

	8	9	A	B	C	D	E	F
0	๘	๙	ไ	ฐ	ภ	๕	เ	๐
1	๕๕	๕๖	ภ	ฑ	ม	๖	แ	๑
2	๕๖	๕๗	บ	ผ	ย	๗	โ	๒
3	๕๗	๕๘	ป	ผ	ร	๘	ใ	๓
4	๕๘	๕๙	ค	ด	ถ	๙	ไ	๔
5	๕๙	๖๐	ค	ด	ล	๐	๗	๕
6	๖๐	๖๑	ฆ	ถ	ภ	๑	๗	๖
7	๖๑	๖๒	ง	ท	ว	๒	๘	๗
8	๖๒	๖๓	จ	ฐ	ศ	๓	.	๘
9	๖๓	๖๔	ฉ	น	ษ	๔	๘	๙
A	๖๔	๖๕	ช	บ	ส	๕	๘	๐
B	๖๕	๖๖	ซ	ป	ห	-	+	๑
C	๖๖	๖๗	ฉ	ผ	ฝ	๗	๘	๒
D	๖๗	๖๘	ฎ	ฝ	อ	T	๐	๓
E	๖๘	๖๙	ฏ	พ	ฮ	๗	๘	๔
F	๖๙	๗๐	ฏ	พ	๗	๘	๐	

EPSON	TITLE	SHEET REVISION	NO.	
	TM-U200 series Specification (STANDARD)	1	NEXT 37	SHEET 36

3.2.12 Page 22 (Thai character code 13)

	8	9	A	B	C	D	E	F
0		๒-		๒๓	๒๔	๒๕	๒๖	๒๗
1	๒๘	๒๙	๒๐	๒๑	๒๒	๒๓	๒๔	๒๕
2	๒๖	๒๗	๒๘	๒๙	๒๐	๒๑	๒๒	๒๓
3	๒๔	๒๕	๒๖	๒๗	๒๘	๒๙	๒๐	๒๑
4	๒๒		๒๓	๒๔	๒๕	๒๖	๒๗	๒๘
5		๒-	๒๑	๒๒	๒๓	๒๔	๒๕	๒๖
6	๒๗	๒๘	๒๙	๒๐	๒๑	๒๒	๒๓	๒๔
7	๒๕	๒๖	๒๗	๒๘	๒๙	๒๐	๒๑	๒๒
8	๒๓	๒๔	๒๕	๒๖	๒๗	๒๘	๒๙	๒๐
9	๒๑		๒๒	๒๓	๒๔	๒๕	๒๖	๒๗
A		๒-	๒๑	๒๒	๒๓	๒๔	๒๕	๒๖
B	๒-	๒๑	๒๒	๒๓	๒๔	๒๕	๒๖	๒๗
C	๒๑	๒๒	๒๓	๒๔	๒๕	๒๖	๒๗	๒๘
D	๒๒	๒๓	๒๔	๒๕	๒๖	๒๗	๒๘	๒๙
E	๒๓		๒๔	๒๕	๒๖	๒๗	๒๘	๒๙
F	๒๔		๒๕	๒๖	๒๗	๒๘	๒๙	๒๐

Confidential

3.2.13 Page 23 (Thai character code 14)

	8	9	A	B	C	D	E	F
0	ร	๙		๕	๖	๗	๘	๙
1	๑	๒	๓	๔	๕	๖	๗	๘
2	๑	๒	๓	๔	๕	๖	๗	๘
3	๑	๒	๓	๔	๕	๖	๗	๘
4	๑	๒	๓	๔	๕	๖	๗	๘
5	๑	๒	๓	๔	๕	๖	๗	๘
6	๑	๒	๓	๔	๕	๖	๗	๘
7	๑	๒	๓	๔	๕	๖	๗	๘
8	๑	๒	๓	๔	๕	๖	๗	๘
9	๑	๒	๓	๔	๕	๖	๗	๘
A	๑	๒	๓	๔	๕	๖	๗	๘
B	๑	๒	๓	๔	๕	๖	๗	๘
C	๑	๒	๓	๔	๕	๖	๗	๘
D	๑	๒	๓	๔	๕	๖	๗	๘
E	๑	๒	๓	๔	๕	๖	๗	๘
F	๑	๒	๓	๔	๕	๖	๗	๘

EPSON	TITLE	TM-U200 series Specification (STANDARD)	SHEET REVISION	NO.	
			1	NEXT 39	SHEET 38

3.2.14 Page 24 (Thai character code 16)

	8	9	A	B	C	D	E	F
0	ร	โ		ฐ	ภ	ะ	เ	อ
1	ร	โ	ก	ท	ม	ะ	แ	อ
2	L	ะ	บ	ผ	ย	า	ะ	๒
3	J	ะ	บ	ผ	ร	า	อ	๓
4		ะ	ค	ต	ถ	า	ะ	๔
5	-	ะ	ค	ต	ล	า	า	๕
6	+	ะ	ข	ถ	ภ	า	า	๖
7	+	ะ	ง	ท	ว	า	ล	๗
8	+	ะ	จ	อ	ศ	ะ	.	๘
9	T	ะ	ฉ	น	ช	ะ	ะ	๙
A	+	ะ	ช	บ	ส	.	ะ	๑๐
B	■	ะ	ช	บ	ท	ะ	+	๑๑
C	←	ะ	ฉ	ผ	พ	ะ	ะ	๑๒
D	↑	ะ	ฉ	ผ	อ	ะ	๐	๑๓
E	→	ะ	ฉ	พ	ช	ะ	โ	๑๔
F	↓	เ	ฉ	พ	า	฿	๐	

EPSON	TITLE	TM-U200 series Specification (STANDARD)	SHEET REVISION	NO.	
			1	NEXT 40	SHEET 39

Confidential

3.2.15 Page 25 (Thai character code 17)

	8	9	A	B	C	D	E	F
0	๘	๙		๘	๙	๘	๙	๐
1	๘๘	๙๘	๙	๙	๘	๘	๙	๑
2	๘๙	๙๙	๘	๙	๙	๙	๘	๒
3	๘+	๙+	๘	๙	๘	๙	๘	๓
4	๘-	๙-	๘	๙	๘	๙	๘	๔
5	๘๘		๘	๙	๘	๙	๘	๕
6	๘๙	-	๘	๙	๘	๙	๘	๖
7	๘+	+	๘	๙	๘	๙	๘	๗
8	๘-	๙	๘	๙	๘	๙	๘	๘
9	๘๘	๙	๘	๙	๘	๙	๘	๙
A	๘๙	L	๘	๙	๘	๙	๘	๐
B	๘+	J	๘	๙	๘	๙	๘	๑
C	๘-	T	๘	๙	๘	๙	๘	๒
D	๘๘	T	๘	๙	๘	๙	๘	๓
E	๘๙	+	๘	๙	๘	๙	๘	๔
F	๘+	J	๘	๙	๘	๙	๘	๕

EPSON	TITLE	SHEET REVISION	NO.	
	TM-U200 series Specification (STANDARD)	I	NEXT 41	SHEET 40

3.2.16 Page 26 (Thai character code 18)

	8	9	A	B	C	D	E	F
0	ร	๙		๕	๖	๗	๘	๐
1	๑	๒	๓	๔	๕	๖	๗	๘
2	๙	๐	๑	๒	๓	๔	๕	๖
3	๐	๑	๒	๓	๔	๕	๖	๗
4	๑	๒	๓	๔	๕	๖	๗	๘
5	๒	๓	๔	๕	๖	๗	๘	๙
6	๓	๔	๕	๖	๗	๘	๙	๐
7	๔	๕	๖	๗	๘	๙	๐	๑
8	๕	๖	๗	๘	๙	๐	๑	๒
9	๖	๗	๘	๙	๐	๑	๒	๓
A	๗	๘	๙	๐	๑	๒	๓	๔
B	๘	๙	๐	๑	๒	๓	๔	๕
C	๙	๐	๑	๒	๓	๔	๕	๖
D	๐	๑	๒	๓	๔	๕	๖	๗
E	๑	๒	๓	๔	๕	๖	๗	๘
F	๒	๓	๔	๕	๖	๗	๘	๙

EPSON	TITLE	SHEET REVISION	NO.	
	TM-U200 series Specification (STANDARD)	1	NEXT 42	SHEET 41

Confidential

3.2.17 Page 254 (space page)

	HEX	8	9	A	B	C	D	E	F
HEX	BIN	1000	1001	1010	1011	1100	1101	1110	1111
0	0000	SP 128	SP 144	SP 160	SP 176	SP 192	SP 208	SP 224	SP 240
1	0001	SP 129	SP 145	SP 161	SP 177	SP 193	SP 209	SP 225	SP 241
2	0010	SP 130	SP 146	SP 162	SP 178	SP 194	SP 210	SP 226	SP 242
3	0011	SP 131	SP 147	SP 163	SP 179	SP 195	SP 211	SP 227	SP 243
4	0100	SP 132	SP 148	SP 164	SP 180	SP 196	SP 212	SP 228	SP 244
5	0101	SP 133	SP 149	SP 165	SP 181	SP 197	SP 213	SP 229	SP 245
6	0110	SP 134	SP 150	SP 166	SP 182	SP 198	SP 214	SP 230	SP 246
7	0111	SP 135	SP 151	SP 167	SP 183	SP 199	SP 215	SP 231	SP 247
8	1000	SP 136	SP 152	SP 168	SP 184	SP 200	SP 216	SP 232	SP 248
9	1001	SP 137	SP 153	SP 169	SP 185	SP 201	SP 217	SP 233	SP 249
A	1010	SP 138	SP 154	SP 170	SP 186	SP 202	SP 218	SP 234	SP 250
B	1011	SP 139	SP 155	SP 171	SP 187	SP 203	SP 219	SP 235	SP 251
C	1100	SP 140	SP 156	SP 172	SP 188	SP 204	SP 220	SP 236	SP 252
D	1101	SP 141	SP 157	SP 173	SP 189	SP 205	SP 221	SP 237	SP 253
E	1110	SP 142	SP 158	SP 174	SP 190	SP 206	SP 222	SP 238	SP 254
F	1111	SP 143	SP 159	SP 175	SP 191	SP 207	SP 223	SP 239	SP 255

EPSON	TITLE	TM-U200 series Specification (STANDARD)	SHEET REVISION	NO.	
			I	NEXT 43	SHEET 42

Confidential

3.2.18 Page 255 (space page)

	HEX	8	9	A	B	C	D	E	F
HEX	BIN	1000	1001	1010	1011	1100	1101	1110	1111
0	0000	SP 128	SP 144	SP 160	SP 176	SP 192	SP 208	SP 224	SP 240
1	0001	SP 129	SP 145	SP 161	SP 177	SP 193	SP 209	SP 225	SP 241
2	0010	SP 130	SP 146	SP 162	SP 178	SP 194	SP 210	SP 226	SP 242
3	0011	SP 131	SP 147	SP 163	SP 179	SP 195	SP 211	SP 227	SP 243
4	0100	SP 132	SP 148	SP 164	SP 180	SP 196	SP 212	SP 228	SP 244
5	0101	SP 133	SP 149	SP 165	SP 181	SP 197	SP 213	SP 229	SP 245
6	0110	SP 134	SP 150	SP 166	SP 182	SP 198	SP 214	SP 230	SP 246
7	0111	SP 135	SP 151	SP 167	SP 183	SP 199	SP 215	SP 231	SP 247
8	1000	SP 136	SP 152	SP 168	SP 184	SP 200	SP 216	SP 232	SP 248
9	1001	SP 137	SP 153	SP 169	SP 185	SP 201	SP 217	SP 233	SP 249
A	1010	SP 138	SP 154	SP 170	SP 186	SP 202	SP 218	SP 234	SP 250
B	1011	SP 139	SP 155	SP 171	SP 187	SP 203	SP 219	SP 235	SP 251
C	1100	SP 140	SP 156	SP 172	SP 188	SP 204	SP 220	SP 236	SP 252
D	1101	SP 141	SP 157	SP 173	SP 189	SP 205	SP 221	SP 237	SP 253
E	1110	SP 142	SP 158	SP 174	SP 190	SP 206	SP 222	SP 238	SP 254
F	1111	SP 143	SP 159	SP 175	SP 191	SP 207	SP 223	SP 239	SP 255

EPSON	TITLE	SHEET REVISION	NO.	
	TM-U200 series Specification (STANDARD)	I	NEXT 44	SHEET 43

Confidential

3.2.19 International character set

Country	ASCII code (Hex)											
	23	24	40	5B	5C	5D	5E	60	7B	7C	7D	7E
U.S.A	#	\$	@	[¥]	^	`	{		}	~
France	#	\$	à	°	ç	§	^	`	é	ù	è	¨
Germany	#	\$	§	Ä	Ö	Ü	^	`	ä	ö	ü	ß
U.K.	£	\$	@	[¥]	^	`	{		}	~
Denmark I	#	\$	@	Æ	Ø	Å	^	`	æ	ø	å	~
Sweden	#	¤	É	Ä	Ö	Å	Ü	é	ä	ö	å	ü
Italy	#	\$	@	°	¥	é	^	ù	à	ò	è	ì
Spain I	Pt	\$	@	i	Ñ	¿	^	`	¨	ñ	}	~
Japan	#	\$	@	[¥]	^	`	{		}	~
Norway	#	¤	É	Æ	Ø	Å	Ü	é	æ	ø	å	ü
Denmark II	#	\$	É	Æ	Ø	Å	Ü	é	æ	ø	å	ü
Spain II (*)	#	\$	á	i	Ñ	¿	é	`	í	ñ	ó	ú
Latin America (*)	#	\$	á	i	Ñ	¿	é	ü	í	ñ	ó	ú
Korea (*)	#	\$	@	[₩]	^	`	{		}	~

(*) These character sets are not supported in the single-color printing model of the type D.

EPSON	TITLE	SHEET REVISION	NO.	
	TM-U200 series Specification (STANDARD)	I	NEXT 45	SHEET 44

3.3 Switches and Buttons

3.3.1 Power switch

The power switch (rocker switch) is on the lower right front of the printer and turns the power on or off.

3.3.2 Panel buttons

FEED button

[Type] Non-locking push button

The **ESC c 5** command enables or disables the panel button. When disabled, the FEED button will not function. If "disabled" is set, the paper feed switch no longer functions. However, when loading roll paper, if the paper loading wait time has been set with "**GS z 0**", the paper feed switch can be used to feed the paper forward within the set time. If the feed switch is pressed while the printer is in the on-line recovery wait state, the printer goes back on-line. (For details, refer to command "**GS z 0**".) The default settings differ for each model type.

[Function] Feeds paper based upon the line feed amount set by the **ESC 2** and **ESC 3** commands.

3.3.3 DIP switches (For type B/D)

1) RS-232 Serial interface model

Table 3.3.1 DIP Switch 1

Switch No.	Function	ON	OFF
1	Data reception error	Ignored	Prints "?"
2	Receive buffer capacity	40 bytes	Approximately 1K bytes
3	Handshaking	XON/XOFF	DTR/DSR
4	Word length	7 bit	8 bit
5	Parity check	Yes	No
6	Parity selection	Even	Odd
7	Baud rate selection	4800 bps	9600 bps
8	BUSY condition	•Receive buffer-full	•Off-line •Receive buffer-full

Table 3.3.2 DIP Switch 2 (Single-color print version)

Switch No.	Function	ON	OFF
1	Selects number of characters per line (CPL) 7 × 9 font / 9 × 9 font	42 CPL / 35 CPL	40 CPL / 33 CPL
2	Print head unit	Ab type	Ca type
3	Pin 6 reset signal	Used	Not used
4	Pin 25 reset signal	Used	Not used

EPSON	TITLE TM-U200 series Specification (STANDARD)	SHEET REVISION I	NO.	
			NEXT 46	SHEET 45

Table 3.3.3 DIP Switch 2 (2-color print version)

Switch No.	Function	ON	OFF
1	Selects number of characters per line (CPL) 7×9 font / 9×9 font	42 CPL / 35 CPL	40 CPL / 33 CPL
2	For internal use only (see *1)	--	--
3	Pin 6 reset signal	Used	Not used
4	Pin 25 reset signal	Used	Not used

*1 : Do not change the settings of DIP switches 2-2

Note: The DIP switch settings are valid only when the power is turned on or the printer is reset with the interface connector. If the DIP switch settings are later changed, the new settings will be invalid.(Except the setting of the DIP switches 2-3 and 2-4) .

2) Parallel interface model

Table 3.3.4 DIP Switch 1

Switch No.	Function	ON	OFF
1	Auto line feed	Enabled	Disabled
2	Receive buffer	40 bytes	Approximately 1Kbyte
3 - 7	Undefined	--	--
8	Busy condition	•Receive buffer-full	•Off-line •Receive buffer-full

Table 3.3.5 DIP Switch 2 (Single-color print version)

Switch No.	Function	ON	OFF
1	Print column selection 7 × 9 font / 9 × 9 font	42CPL / 35CPL	40CPL / 33CPL
2	Print head unit	Ab type	Ca type
3	Undefined	--	--
4	Internal use	--	--

Table 3.3.6 DIP Switch 2 (2-color print version)

Switch No.	Function	ON	OFF
1	Print column selection 7 × 9 font / 9 × 9 font	42CPL / 35CPL	40CPL / 33CPL
2	Internal use (*1)	--	--
3	Undefined	--	--
4	Internal use	--	--

*1 : Do not change the settings of DIP switches 2-2.

Note: The DIP switch settings are valid only when the power is turned on or the printer is reset with the interface connector. If the DIP switch settings are later changed, the new settings will be invalid.(Except the setting of the DIP switch 2-4) .

EPSON	TITLE TM-U200 series Specification (STANDARD)	SHEET REVISION I	NO.	
			NEXT 47	SHEET 46

3.3.4 DIP switches (For type A/AM)

1) RS-232 Serial interface model

Table 3.3.7 DIP Switch 1

Switch No.	Function	ON	OFF
1	Data reception error	Ignored	Prints “?”
2	Receive buffer capacity	40 bytes	Type A: 1000 bytes Type AM: 512 bytes
3	Handshaking	XON/XOFF	DTR/DSR
4	Word length	7 bit	8 bit
5	Parity check	Yes	No
6	Parity selection	Even	Odd
7	Baud rate selection	4800 bps	9600 bps
8	BUSY condition	•Receive buffer-full	•Off-line •Receive buffer-full

Table 3.3.8 DIP Switch 2

Switch No.	Function	ON	OFF
1	Selects number of characters per line (CPL) 7×9 font / 9×9 font	42 CPL / 35 CPL	40 CPL / 33 CPL
2	For internal use only (see *1)	--	--
3	Undefined	--	--
4	Undefined	--	--
5	For internal use only (*1)	--	--
6	For internal use only (*1)	--	--
7	Pin 6 reset signal	Used	Not used
8	Pin 25 reset signal	Used	Not used

*1 : Do not change the settings of DIP switches 2-2, 2-5, and 2-6.

2) Parallel interface model

Table 3.3.9 DIP Switch 1

Switch No.	Function	ON	OFF
1	Auto line feed	Enabled	Disabled
2	Receive buffer	40 bytes	Type A: 1000 bytes Type AM: 512 bytes
3 - 7	Undefined	--	--
8	Busy condition	•Receive buffer-full	•Off-line •Receive buffer-full

EPSON	TITLE TM-U200 series Specification (STANDARD)	SHEET REVISION I	NO.	
			NEXT 48	SHEET 47

Table 3.3.10 DIP Switch 2

Switch No.	Function	ON	OFF
1	Selects number of characters per line (CPL) 7×9 font / 9×9 font	42 CPL / 35 CPL	40 CPL / 33 CPL
2	For internal use only (see *1)	--	--
3	For internal use only (see *1)	--	--
4	Undefined	--	--
5	For internal use only (*1)	--	--
6	For internal use only (*1)	--	--
7	Undefined	--	--
8	Pin 31 reset signal	Used	Not used

*1 : Do not change the settings of DIP switches 2-2, 2-3, 2-5, and 2-6.

3.4 Panel LED Indicators

3.4.1 Panel LED indicators

- (1) Power supply (POWER) LED: Green
 - ON: Power supply is stable.
 - OFF: Power supply is not stable.
 - (2) Paper roll near-end (PAPER OUT) LED: Red
 - ON: Near-end or end of paper roll is detected. (*1)
 - OFF: Adequate paper remains on the paper roll (normal condition).
 - Blinking: Waiting for recovers to on-line status after automatic paper feeding. Or for restarting test printing on paper roll.
- *1: Near-end detector is optionally installed. The printer which does not install the detector always indicates the normal condition.
- (3) Error (ERROR) LED: Red
 - ON: Off-line (except during paper feeding using the FEED button and during the self-test).
 - Blinking: Error state. (See Section 3.5, Error Processing)
 - OFF: Normal operation.

3.5 Error Processing

3.5.1 Error types

- 1) Error that is automatically recovered

Table 3.5.1 Automatically Recoverable Error

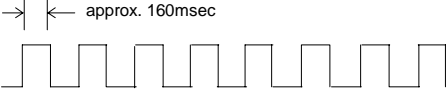
Error	Description	ERROR LED blinking pattern	Recovery
Print head temperature error (*)	Print head temperature is extremely high	 → ← approx. 160msec	Automatically recovers when the print head temperature falls.

(*) A print head temperature error is not abnormal.

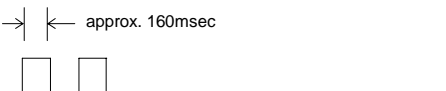
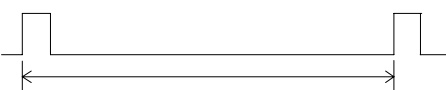

- 2) Errors that may be recovered via commands

Table 3.5.2 Command-recoverable Errors

Error	Description	ERROR LED blinking pattern	Recovery
Home position detection error (mechanical error)	Home position cannot be detected due to a paper jam or other problem.	 → ← approx. 160msec	Recovers using DLE ENQ 2.
Auto cutter error (For type B)	Abnormality in the auto cutter.	 ←—————→ Approximately 2.56sec	Recovers using DLE ENQ 2.

3) Errors that cannot be recovered

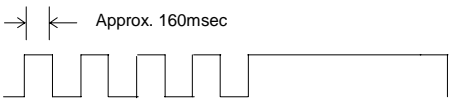
Table 3.5.3 Unrecoverable Errors

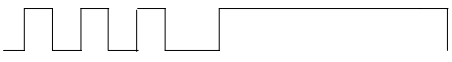
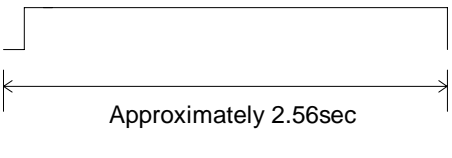
Error	Description	ERROR LED blinking pattern	Recovery
CPU execution error	CPU executes incorrect address		Impossible to recover.
High voltage error	Power voltage is extremely high.		Impossible to recover.
Low voltage error	Power voltage is extremely low.		Impossible to recover.
Print head temperature detection circuit error	Abnormality in the mechanism or circuit connection. Or abnormality in the print head temperature		Impossible to recover.

NOTE: If an error that cannot be recovered occurs, turn off the power as soon as possible.

3.5.2 Operation when an error is detected

The printer executes the following operations when detecting an error:

<Serial interface model>

- Stops all mechanical operation.
- Sets the DTR signal to MARK.
- Blinks the ERROR LED
- Transmits XOFF if XON/XOFF control is selected.

<Parallel interface model>

- Stops all mechanical operation.
- Sets the Busy signal to HIGH.
- Blinks the ERROR LED.
- Sets the nFault signal to LOW.

3.5.3 Data reception error

If any of the following data reception errors occur during serial interface communication, the printer prints " ? " or ignores the data, according to the setting of DIP switch 1-1.

- Parity error
- Framing error
- Overrun error

EPSON	TITLE	TM-U200 series Specification (STANDARD)	SHEET REVISION	NO.	
			I	NEXT 51	SHEET 50

3.6 Self-test

(1) The printer has a self-test function that checks the following:

- Control circuit functions
- Printer mechanisms
- Print quality
- Control ROM version
- DIP switch settings

(2) Self-test on paper roll

[Starting the self-test]

To start the self-test on a paper roll, hold down the feed button and turn on the printer with the cover closed. The printer then prints the current printer status, which provides the following information:

- Control ROM version
- DIP switch settings

[Self-test standby state]

After printing the current printer status, the printer prints the message "Self-test printing. Press FEED button". The PAPER OUT LED blinks, and the printer enters the test printing standby state. Press the feed button in this state to start test printing.

(3) Ending the self-test

After a number of lines are printed, the printer indicates the end of the self-test by printing "**** completed ****", performs initialization, and then goes to normal mode.

EPSON	TITLE	TM-U200 series Specification (STANDARD)	SHEET REVISION	NO.	
			I	NEXT 52	SHEET 51

3.7 Hexadecimal Dumping

(1) Hexadecimal dump function

This function prints the data transmitted from the host in hexadecimal numbers and their corresponding characters.

(2) Starting hexadecimal dumping

Turn the printer power off and set DIP switch 1-2 to on to select 40 bytes for the receive buffer capacity. Then, turn on the power while pressing the FEED button. Before finishing the initialization of the printer, release the FEED button, then press the FEED button again. The printer first prints "Hexadecimal Dump" on the paper roll, and prints the data received thereafter in hexadecimal numbers and their corresponding characters. The hexadecimal dumping is also executed with the **GS (A** command.

- NOTES:
1. "." is printed if no character corresponds to the data received.
 2. During hexadecimal dumping, all commands except **DLE EOT** and **DLE ENQ** are disabled.
 3. Insufficient print data to fill the last line can be printed by setting the printer off-line.

(3) Ending hexadecimal dumping

End hexadecimal dumping by turning off the power, by pressing the FEED button three times, or by resetting the printer after printing completes.

< Example printing >

```

Hexadecimal Dump
To terminate hexadecimal dump,
press FEED button three times.

1B 40 1B 21 30 41 42 43 : .@.!0ABC
44 45 46 47 0A          : DEFG.

*** completed ***
  
```

EPSON	TITLE	TM-U200 series Specification (STANDARD)	SHEET REVISION	NO.	
			I	NEXT 53	SHEET 52

3.8 Paper Detectors

- The printer has the following paper detectors:
- Paper roll end detector
 - Paper roll near-end detector (Optional)

3.8.1 Detectors and LED indicators

(1) Roll paper end detector

This detector is located in the roll paper path. This detector detects paper out. When the paper out is detected, the PAPER OUT LED lights.

(2) Paper roll near-end detector (optional)

This sensor is installed on the paper roll supply device. It detects a paper near-end by monitoring the paper roll diameter. The PAPER OUT LED lights when the paper roll diameter becomes sufficiently small.

3.8.2 Detectors and printing

When the printer detects a paper-end, it stops or continues printing, depending on the **ESC c 4** command setting. The roll paper detector always halts printing when there is no paper.

3.9 Buffer-full Printing

When subsequent data is received after the printer processes one line of data in the print buffer, the printer automatically prints the processed line and feeds the paper by one line.

3.10 Loading the Paper Roll (Refer to 6.4 Command descriptions, GS z 0 t1 t2)

3.10.1 For type B/D

Make sure to load the paper roll correctly according to the description of the caution seal which is attached inside of the printer cover.
 After inserting the paper in the paper entrance, the printer loads the paper automatically, then close the cover. Confirm that the PAPER OUT LED is flashing, and then press the feed switch. The PAPER OUT LED stops flashing and the printer goes back on-line, ready to print. When closing the printer cover and pressing the FEED switch, the PAPER OUT LED turns off and the printer becomes on-line status.

3.10.2 For type A/AM

Make sure to load the paper roll correctly according to the description of the caution seal which is attached inside of the printer cover.
 After inserting the paper in the paper entrance, the printer loads the paper automatically, then set the tip of the journal paper in the slit on the spool of the take-up unit and cut the receipt with a manual cutter.
 When closing the auto cutter unit and the printer cover after loading the paper, the printer becomes on-line status automatically.

EPSON	TITLE TM-U200 series Specification (STANDARD)	SHEET REVISION I	NO.	
			NEXT 54	SHEET 53

4. CASE SPECIFICATIONS

4.1 External Dimensions and Weight

Model type	External Dimensions			Weight
	Width	Height	Depth	
A/AM	160 mm (approximately 6.3")	160 mm (approximately 6.3")	295 mm (approximately 11.6")	Approximately 2.5 Kg
B	160 mm (approximately 6.3")	150 mm (approximately 5.9")	248 mm (approximately 9.8")	Approximately 2.5 Kg
D	160 mm (approximately 6.3")	133 mm (approximately 5.2")	248 mm (approximately 9.8")	Approximately 2.2 Kg

4.2 Color

Epson standard color

4.3 External Appearance



Figure 4.3.1 External Appearance (Type A/AM)

EPSON	TITLE	TM-U200 series Specification (STANDARD)	SHEET	NO.	
			REVISION	NEXT	SHEET
			I	55	54

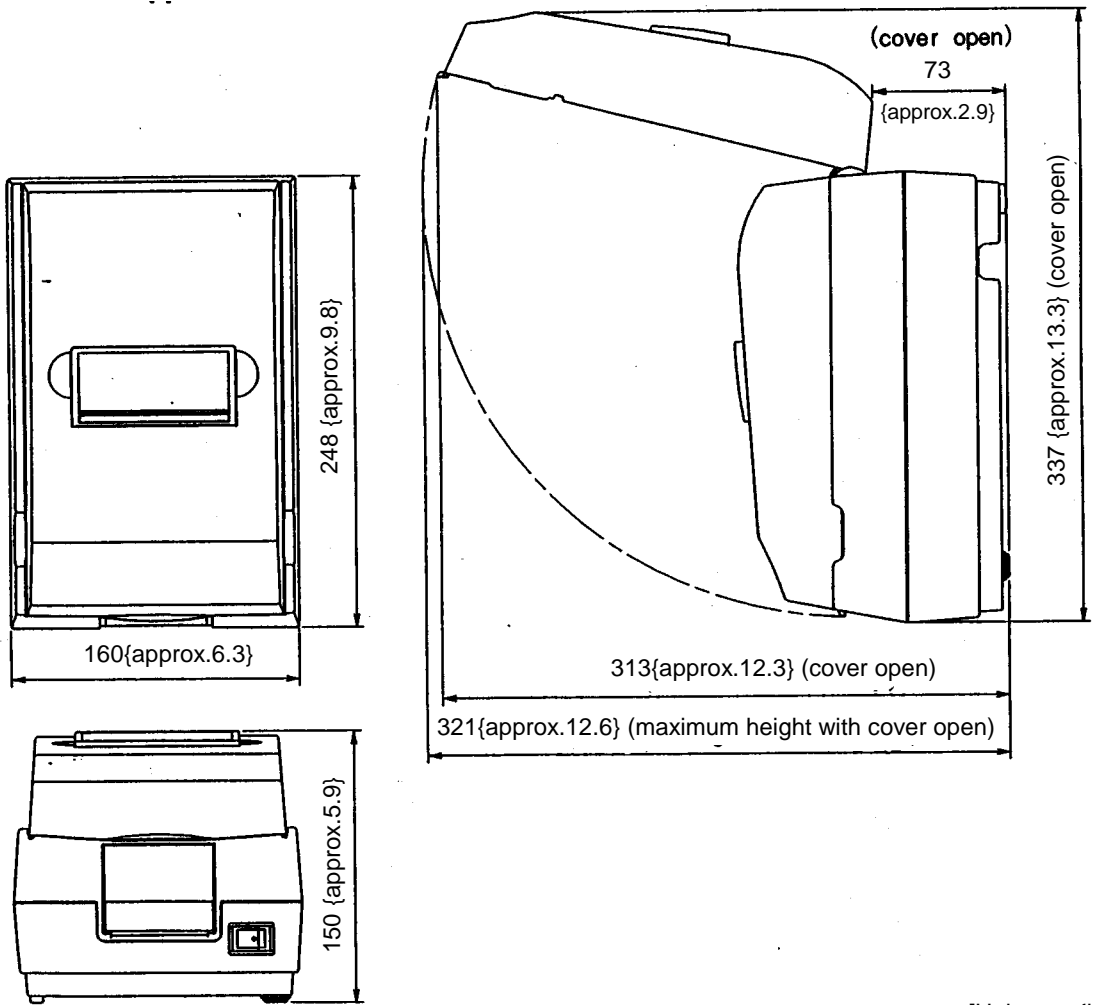

[Unit: mm {inch}]

Figure 4.3.2 External Appearance (Type B)

EPSON	TITLE	TM-U200 series Specification (STANDARD)	SHEET REVISION	NO.	
			I	NEXT 56	SHEET 55

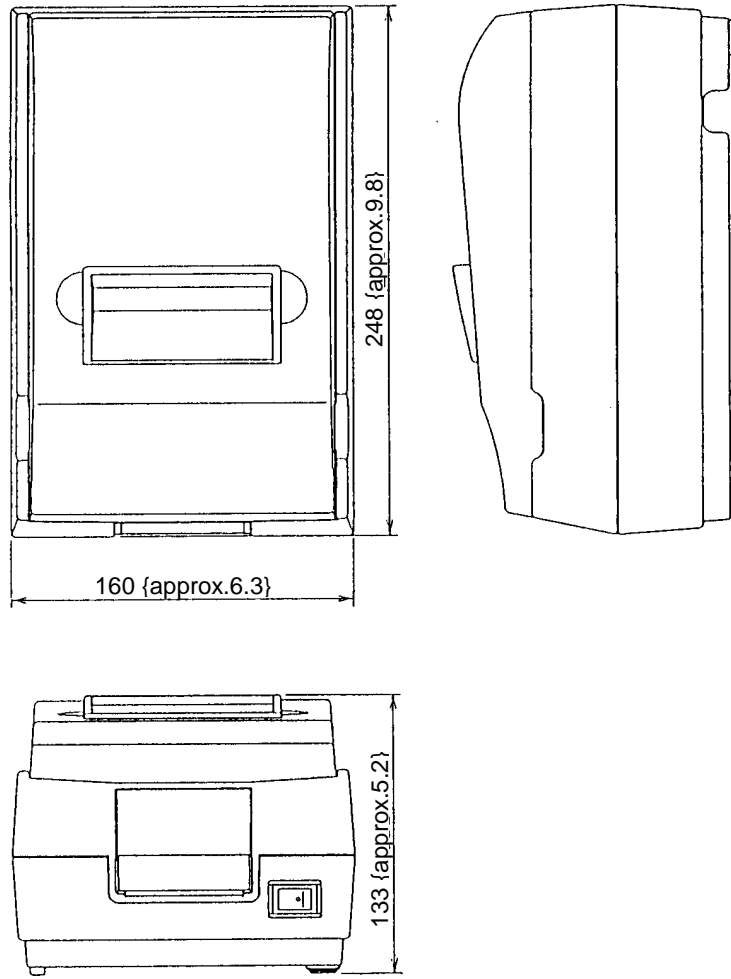

Figure 4.3.3 External Appearance (Type D)

[Unit : mm {inch}]

EPSON	TITLE	TM-U200 series Specification (STANDARD)	SHEET REVISION	NO.	
			I	NEXT 57	SHEET 56

5. ACCESSORIES AND OPTIONS

5.1 Standard Accessories

- Exclusive ribbon cassette (ERC-38 (P) or ERC-38(B/R))
- Paper roll
- Operator's manual
- AC adapter (Refer to Table 5.1.1 for settings at shipment)

Table 5.1.1 for settings at Shipment

Settings at Shipment	Voltage	AC Adapter Model Name
Japan	100 V	PA-6508
North America	120 V	PB-6509
Europe (Germany)	230 V	PB-6510
Europe (U.K)	230 V	PA-6511
Australia	240 V	PA-6513

5.1.1 External appearance and weight of the AC adapter

1) Overall dimensions

Type Symbol	PA type	PB type
A	75	80
B	61	68
C	110	125
D	135	146

[Units: mm]

2) Weight

PA type	PB type
1.25	1.35

[Units: kg]

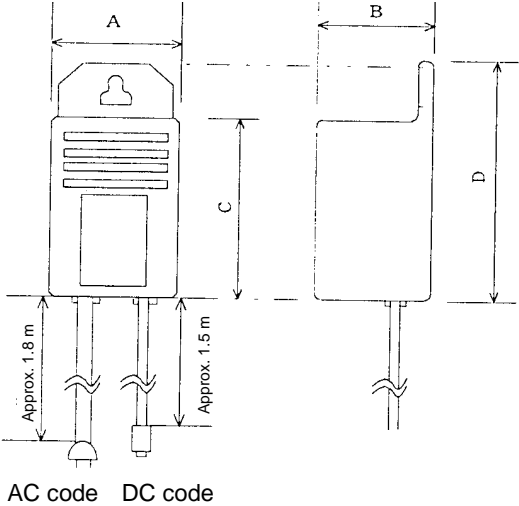
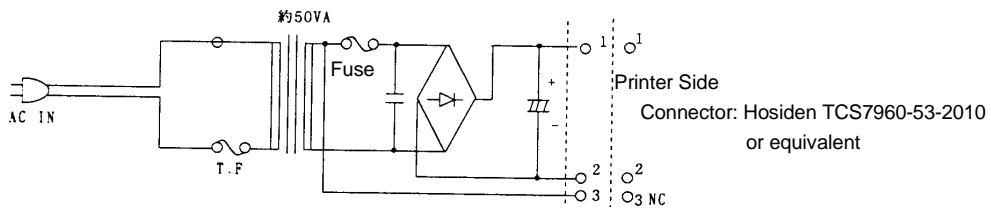

Figure 5.1.1 External Appearance of the AC adapter

EPSON	TITLE	TM-U200 series Specification (STANDARD)	SHEET REVISION	NO.	
			I	NEXT 58	SHEET 57



The figure below shows the configuration of the AC adapter. Please handle it carefully.

NOTE 1: The two AC adapters differ in external appearance and in whether they connect to connector terminal 3 of the DC cord. In the TM-U200, connector terminal 3 of the DC cord is not used. When designing the system, be sure to allow enough space to install either AC adapter. (The PB type is larger than the PA type.)

NOTE 2: Cautions regarding the connection of this AC adapter to Epson customer displays:

- Never use with the DM-D101 or the DM-D202.
- Possible use the DM-101 II or the DM-202 II.

Figure 5.1.2 Internal Circuitry of the AC adapter

5.2 Options

- Paper roll near-end detector (Available optionally at dealer)
- AC adapter PS-170 (sold separately)
- Printer fastening tape (Model No. DF-10)

5.3 Interface Board

- IEEE 1284 compatible interface board (Bi-directional parallel: option)
- RS-232 compatible interface board (option)
- RS-485 compatible interface board (option)

EPSON	TITLE	SHEET REVISION	NO.	
	TM-U200 series Specification (STANDARD)	I	NEXT 59	SHEET 58

6. Commands

6.1 Command Notation

XXXX

[Name]	The name of the command.
[Format]	The code sequence.
[Range]	Gives the allowable ranges for the arguments.
[Description]	Describes the command's function.
[Notes]	Provides important information on setting and using the printer command, if necessary. Item(s) marked with * indicates "important notice".
[Default]	Gives the default values,(if any) for the command arguments.
[Reference]	Lists related commands.
[Example]	Gives examples of how to use the command.

ASCII indicates the ASCII equivalents.

Hex indicates the hexadecimal equivalents.

Decimal indicates the decimal equivalents.

[]*k* indicates the contents of the [] should be repeated *k* times.

6.2 Explanation of Terms

(1) Reception buffer

The reception buffer is a buffer that stores, as is, the data received from the host (the reception data). The reception data is stored in the reception buffer temporarily, and is then processed sequentially.

(2) Print buffer

The print buffer is a buffer that stores the image data to be printed.

(3) Print buffer full

This is the state where the print buffer is full. If new print data is input while the print buffer is full, the data in the print buffer is printed out and a line feed is executed. This is the same operation as the **LF** operation.

(4) Start of line

The start of line state satisfies the following condition:

- There is no print data (including spaces and portions of data skipped due to **HT**) currently in the print buffer.

EPSON	TITLE TM-U200 series Specification (STANDARD)	SHEET REVISION 1	NO.	
			NEXT 60	SHEET 59

Confidential

(5) Printable area

The maximum range within which printing is possible under the printer specifications. The printable area for this printer is 400/160 inches.

(6) Ignore

The state in which all codes, including parameters, are read in and discarded, and nothing happens.

(7) Invalid

The state in which the command portion of codes is read in and discarded, while the parameter portion of codes is treated as normal data.

(8) Inch

A unit of length. One inch is 25.4mm.

(9) MSB

Most Significant Bit

(10) LSB

Least Significant Bit

6.3 Exception Processing

6.3.1 Undefined codes

This term refers to the codes ranging from 00H to 1FH in the character code table. If a code in this range that is not defined as a command is input, that code (one byte) is read in and discarded, and subsequent data is processed as normal data.

Example: 30H, 31H, 03H, 32H, 0AH, 33H

If the above data string is input, the printer reads in and discards "03H" as an undefined code.

Note that 0AH is defined as a command (**LF**). As a result, the data string that is actually processed is: 30H, 31H, 32H, 0AH, 33H

6.3.2 Undefined commands

If the data following **ESC** (1BH) or **GS** (1DH) is not defined as a command, then the two bytes (**ESC/GS** and the code that follows) are read in and discarded.

Example: 30H, 1BH, 22H, 31H, 32H

If the above data string is input, the printer discards the data 1BH and 22H as undefined commands. As a result, the data string that is actually processed is: 30H, 31H, 32H

EPSON	TITLE TM-U200 series Specification (STANDARD)	SHEET REVISION I	NO.	
			NEXT 61	SHEET 60

6.3.3 Settings outside the defined range

If a value outside of the defined range is input for a command that takes parameters, that command is ignored and the previous value for that setting remains unchanged. In the case of a command that takes multiple parameters, command processing is halted the moment that a value outside of the defined range is input and subsequent values are processed as normal data.

Example: 1BH, 52H, 15H

If the above data string is input, 1BH and 52H are defined as a command (**ESC R**), but the parameter 15H is outside of the defined range. As a result, the printer reads in and discards the data string 1BH, 52H, 15H. Accordingly, the previously set international character set is not changed.

EPSON	TITLE TM-U200 series Specification (STANDARD)	SHEET REVISION 1	NO.	
			NEXT 62	SHEET 61

6.4 Command descriptions

HT

[Name]	Horizontal tab
[Format]	ASCII HT Hex 09 Decimal 10
[Description]	Moves the print position to the next horizontal tab position.
[Notes]	<ul style="list-style-type: none">• This command is valid only when the receive buffer capacity is 40 bytes (when DIP switch 1-2 is on).• This command is ignored unless the next horizontal tab position has been set.• If the next horizontal tab position is outside of the printing area, the printing position shifts to "printing area width + 1."• Horizontal tab positions are set with ESC D.• The default tab positions are at intervals of 8 characters (columns 9, 17, 25..) for the font B (7 × 9).
[Reference]	ESC D

LF

[Name]	Print and line feed
[Format]	ASCII LF Hex 0A Decimal 10
[Description]	Prints the data in the print buffer and feeds one line based on the current line spacing.
[Note]	This command sets the print position to the beginning of the line.
[Reference]	ESC 2, ESC 3

EPSON	TITLE TM-U200 series Specification (STANDARD)	SHEET REVISION 1	NO.	
			NEXT 63	SHEET 62

CR

[Name]	Print and carriage return
[Format]	ASCII CR Hex 0D Decimal 13
[Description]	①For serial interface model <ul style="list-style-type: none"> • This command prints the data in the print buffer and does not feed the paper. ②For parallel interface model <ul style="list-style-type: none"> • When auto-line feed is enabled, this command functions in the same way as LF. When auto-line disabled, this command is disregarded.
[Note]	Sets the print starting position to the beginning of the line
[Reference]	LF

DLE EOT *n*

[Name]	Real-time status transmission
[Format]	ASCII DLE EOT <i>n</i> Hex 10 04 <i>n</i> Decimal 16 4 <i>n</i>
[Range]	$1 \leq n \leq 4$
[Description]	Transmits the selected printer status specified by <i>n</i> in real time, according to the following parameters: <i>n</i> = 1: Transmit printer status <i>n</i> = 2: Transmit off-line status <i>n</i> = 3: Transmit error status <i>n</i> = 4: Transmit paper roll sensor status
[Notes]	<ul style="list-style-type: none"> * The status is transmitted whenever the data sequence of <10>H<04>H<<i>n</i>> ($1 \leq n \leq 4$) is received. For example, In ESC * <i>m</i> nL nH [<i>d</i>] nL+256nH, <i>d</i>1=<10>H, <i>d</i>2=<04>H, <i>d</i>3=<1>H * This command should not be used within the data sequence of another command that consists of 2 or more bytes. For example, If you attempt to transmit ESC 3 <i>n</i> to the printer, but DTR (DSR for the host computer) goes to MARK before <i>n</i> is transmitted and then DLE EOT 3 interrupts before <i>n</i> is received, the code <10>H for DLE EOT 3 is processed as the code for ESC 3 <10>H. <ul style="list-style-type: none"> • The printer executes this command upon receiving it. • When transmitting status, the printer transmits only 1 byte without confirming the condition of the DSR signal. • This command is executed even when the printer is off-line, the receive buffer is full, or there is an error status with a serial interface mode. • With a parallel interface mode, this command can not be executed when the printer is busy. This command is executed even when the printer is off-line or there is an error status when DIP switch 1-8 is on with a parallel interface mode.

<h1 style="margin: 0;">EPSON</h1>	TITLE	SHEET REVISION	NO.	
	TM-U200 series Specification (STANDARD)	1	NEXT 64	SHEET 63

Confidential

- When Auto Status Back (ASB) is enabled using the **GS a** command, the status transmitted by the **DLE EOT** command and the ASB status must be differentiated by using the table in Appendix E.
- This command is effective even if the printer is not selected by set peripheral device command, **ESC =**.

n = 1: Printer status

Bit	Off/On	Hex	Decimal	Function
0	Off	00	0	Not used. Fixed to Off.
1	On	02	2	Not used. Fixed to On.
2	Off	00	0	Drawer kick-out signal is LOW (connector pin 3)
	On	04	4	Drawer kick-out signal is HIGH (connector pin 3)
3	Off	00	0	On-line.
	On	08	8	Off-line.
4	On	10	16	Not used. Fixed to On.
5	Off	00	0	Not waiting for on-line recovery
	On	20	32	Waiting for on-line recovery
6	-	-	-	Undefined.
7	Off	00	0	Not used. Fixed to Off.

n = 2: Off-line status

Bit	Off/On	Hex	Decimal	Function
0	Off	00	0	Not used. Fixed to Off.
1	On	02	2	Not used. Fixed to On.
2	-	-	-	Undefined.
3	Off	00	0	Paper is not being fed by using the paper feed button.
	On	08	8	Paper is being fed by the paper feed button.
4	On	10	16	Not used. Fixed to On.
5	Off	00	0	No paper-end stop.
	On	20	32	Printing stops due to paper end.
6	Off	00	0	No error.
	On	40	64	Error occurs.
7	Off	00	0	Not used. Fixed to Off.

Bit 5: On (printing stops due to paper-end) when printing stops due to paper-end detected by the paper-end sensor or the paper near-end enabled by using the **ESC c 4**.

EPSON	TITLE	TM-U200 series Specification (STANDARD)	SHEET REVISION	NO.	
			I	NEXT 65	SHEET 64

n = 3: Error status

Bit	Off/On	Hex	Decimal	Function
0	Off	00	0	Not used. Fixed to Off.
1	On	02	2	Not used. Fixed to On.
2	Off	00	0	No mechanical error.
	On	04	4	Mechanical error occurred.
3	Off	00	0	No auto-cutter error.
	On	08	8	Auto-cutter error occurs.
4	On	10	16	Not used. Fixed to On.
5	Off	00	0	Unrecoverable error.
	On	20	32	Recoverable error.
6	Off	00	0	Automatic recover error.
	On	40	64	No automatic recover error.
7	Off	00	0	Not used. Fixed to Off.

Bit 2: If these errors occur due to paper jams or the like, it is possible to recover by correcting the cause of the error and executing **DLE ENQ 2**. If an error due to a circuit failure (e.g. wire break) occurs, it is impossible to recover.

Bit 6: If the print head temperature becomes high, bit 6 is transmitted until the print head temperature drops sufficiently. The printer automatically recovers from this error.

n = 4: Continuous paper sensor status

Bit	Off/On	Hex	Decimal	Function
0	Off	00	0	Not used. Fixed to Off.
1	On	02	2	Not used. Fixed to On.
2,3	Off	00	0	Paper near-end sensor. Paper adequate.
	On	0C	12	Paper near-end is detected by the paper near-end sensor.
4	On	10	16	Not used. Fixed to On
5,6	Off	00	0	Paper end sensor. Paper adequate.
	On	60	96	Paper end is detected by the paper end sensor.
7	Off	00	0	Not used. Fixed to Off.

Bits 2 and 3: The "paper roll near end" detector is an option; on units that do not have this option, bits 2 and 3 are "0" (paper adequate).

[Reference] **DLE ENQ, GS a, GS r**, 3.5.1 Error types, Appendix E

EPSON	TITLE	TM-U200 series Specification (STANDARD)	SHEET REVISION	NO.	
			I	NEXT 66	SHEET 65

DLE ENQ *n*

[Name]	Real-time request to printer												
[Format]	<table border="0" style="margin-left: 20px;"> <tr> <td>ASCII</td> <td>DLE</td> <td>ENQ</td> <td><i>n</i></td> </tr> <tr> <td>Hex</td> <td>10</td> <td>05</td> <td><i>n</i></td> </tr> <tr> <td>Decimal</td> <td>16</td> <td>5</td> <td><i>n</i></td> </tr> </table>	ASCII	DLE	ENQ	<i>n</i>	Hex	10	05	<i>n</i>	Decimal	16	5	<i>n</i>
ASCII	DLE	ENQ	<i>n</i>										
Hex	10	05	<i>n</i>										
Decimal	16	5	<i>n</i>										
[Range]	<i>n</i> = 0, <i>n</i> = 2												
[Description]	<p>The printer responds to a request from the host specified by <i>n</i>.</p> <p style="margin-left: 20px;"><i>n</i> = 0: Recovers to on-line state.</p> <p style="margin-left: 20px;"><i>n</i> = 2: Recovers from an error after clearing the receive and print buffers.</p>												
[Notes]	<ul style="list-style-type: none"> * The status is also transmitted whenever the data sequence of <10>H<05>H<<i>n</i>> <i>n</i> = 2 is received. For example, In ESC * <i>m</i> NL NH [<i>d</i>] NL+256nH, <i>d</i>1=<10>H, <i>d</i>2=<05>H, <i>d</i>3=<1>H * This command should not be used within the data sequence of another command that consists of two or more bytes. For example, If you attempt to transmit ESC 3 <i>n</i> to the printer, but DTR (DSR for the host computer) goes to MARK before <i>n</i> is transmitted, and DLE ENQ 2 interrupts before <i>n</i> is received, the code <10>H for DLE ENQ 2 is processed as the code for ESC 3 <10>H. • When the printer is off-line because printing was stopped due to a lack of paper, this command <i>n</i> = 0 is valid from the point when paper is loaded until the printer goes on-line again (the "waiting for on-line recovery" state), while in other cases requests are ignored. • This command <i>n</i> = 2 is valid only when a mechanical error or an auto-cutter error has occurred. • The printer executes this command upon receiving it. • This command is executed even when the receive buffer is full with a serial interface model. With a parallel interface model, this command can not be executed when the printer is busy. • DLE ENQ 2 enables the printer to recover from an error after clearing the data in the receive buffer and the print buffer. The printer retains the settings (by ESC !, ESC 3, etc.) in effect when the error occurred. The printer can be initialized completely by using this command and ESC @. This command is enabled only for errors that have the possibility of recovery, except for print head temperature errors. • This command is effective even if the printer is not selected by set peripheral device command, ESC =. 												
[Reference]	DLE EOT, GS z 0												

EPSON	TITLE	TM-U200 series Specification (STANDARD)	SHEET REVISION	NO.	
			1	NEXT 67	SHEET 66

ESC SP *n*

[Name]	Set right-side character spacing			
[Format]	ASCII	ESC	SP	<i>n</i>
	Hex	1B	20	<i>n</i>
	Decimal	27	32	<i>n</i>
[Range]	$0 \leq n \leq 255$			
[Description]	Sets the character spacing for the right side of the character to [$n \times 0.159$ mm {1/160 inches}].			
[Notes]	<ul style="list-style-type: none"> The right-side character spacing for double-width mode is twice the normal value. 			
[Default]	$n = 0$			

ESC ! *n*

[Name]	Select print mode(s)			
[Format]	ASCII	ESC	!	<i>n</i>
	Hex	1B	21	<i>n</i>
	Decimal	27	33	<i>n</i>
[Range]	$0 \leq n \leq 255$			
[Description]	Selects print mode(s) using <i>n</i> as follows:			

Bit	Off/On	Hex	Decimal	Function
0	Off	00	0	Character font A (9 × 9) selected.
	On	01	1	Character font B (7 × 9) selected.
1	-	-	-	Undefined.
2	-	-	-	Undefined
3	Off	00	0	Emphasized mode not selected.
	On	08	8	Emphasized mode selected.
4	Off	00	0	Double-height mode not selected.
	On	10	16	Double-height mode selected.
5	Off	00	0	Double-width mode not selected.
	On	20	32	Double-width mode selected.
6	-	-	-	Undefined.
7	Off	00	0	Underline mode not selected.
	On	80	128	Underline mode selected.

EPSON	TITLE TM-U200 series Specification (STANDARD)	SHEET REVISION I	NO.	
			NEXT 68	SHEET 67

Confidential

- [Notes]
- When both double-height and double-width modes are selected, quadruple size characters are printed.
 - Underlining is added to the entire width of each character, including the space to the right of a character, but is not added to portions of lines that were skipped by means of an **HT**.
 - The underline setting by this command does not affect the Kanji character printing.

[Default] $n = 1$

[Reference] **ESC E, ESC –**

ESC % n

[Name] Select/cancel user-defined character set

[Format]

ASCII	ESC	%	n
Hex	1B	25	n
Decimal	27	37	n

[Range] $0 \leq n \leq 255$

[Description] Selects or cancels the user-defined character set.

When the Least Significant Bit (LSB) is 0, the user-defined character set is canceled and the internal character set is enabled.

When the LSB is 1, the user-defined character set is selected.

- [Notes]
- * This command is valid only when the receive buffer capacity is 40 bytes (when DIP switch 1-2 is on).
 - Only the least significant bit of " n " is valid.
 - When the downloaded character set has been released, the internal character set is specified automatically.

[Default] $n = 0$

[Reference] **ESC &, ESC ?**

EPSON	TITLE TM-U200 series Specification (STANDARD)	SHEET REVISION 1	NO.	
			NEXT 69	SHEET 68

ESC & y c1 c2 [x1 d1...d(y × x1)]...[xk d1... d(y × xk)]

[Name]	Define user-defined characters
[Format]	ASCII ESC & <i>y c1 c2 [x1 d1...d(y × x1)]...[xk d1... d(y × xk)]</i> Hex 1B 26 <i>y c1 c2 [x1 d1...d(y × x1)]...[xk d1... d(y × xk)]</i> Decimal 27 38 <i>y c1 c2 [x1 d1...d(y × x1)]...[xk d1... d(y × xk)]</i>
[Range]	<i>y</i> = 2 $32 \leq c1 \leq c2 \leq 126$ $0 \leq x \leq 12$ (9 × 9 font) $0 \leq x \leq 9$ (7 × 9 font) $0 \leq d1 \dots d(y \times x) \leq 255$
[Description]	Defines user-defined characters. <ul style="list-style-type: none"> • <i>y</i> specifies the number of bytes in the vertical direction. • <i>c1</i> specifies the beginning character code for the definition, and <i>c2</i> specifies the final code. When only one character is desired, use <i>c1</i> = <i>c2</i>. • <i>x</i> specifies the number of dots in the horizontal direction.
[Notes]	<ul style="list-style-type: none"> * This command is valid only when the receive buffer capacity is 40 bytes (when DIP switch 1-2 is on). • The range of definable character codes extends from 20H to 7EH among the ASCII codes. • Consecutive character codes for multiple characters can be defined in one definition. When specifying only one character, specify <i>c1</i> = <i>c2</i>. • "<i>d</i>" is definition data that indicates the pattern for "<i>x</i>" dots in the horizontal direction starting from the left edge. If "<i>x</i>" does not satisfy the number of dots in the character configuration pattern, the remaining dots on the right are spaces. • The number of bytes required to download a character definition for one character is "<i>y</i>" × "<i>x</i>". • In the definition data, a "1" represents a dot that is to be printed, and a "0" represents a dot that is not to be printed. • Independent downloaded character definitions are possible for each font. The font is selected by the "ESC !" command. • The defined downloaded characters are cleared in the following circumstances: <ol style="list-style-type: none"> 1) When "ESC @" is executed 2) When deleted by "ESC ?" 3) When the printer is reset or turned off • The maximum number of characters that can be defined is 19.(8 for type AM)

EPSON	TITLE	TM-U200 series Specification (STANDARD)	SHEET REVISION	NO.	
			1	NEXT 70	SHEET 69

Confidential

- If downloaded characters equal to the number of characters that can be defined have already been downloaded, Redefinition of the defined ASCII codes is possible, but definition of new ASCII codes is not possible.

[Default] The internal character set

[Reference] **ESC %, ESC ?**

[Example]

7 x 9 font when the dot pattern for code 20H is defined as shown below.

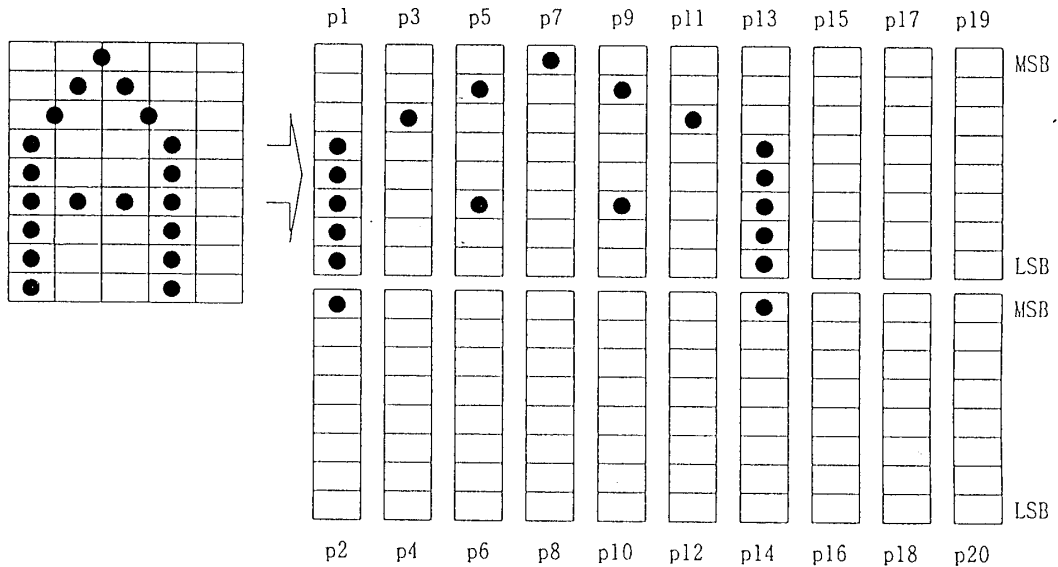

When the dot pattern for code 20H is defined as shown above.

ESC&	y	c1	c2	X	p1	p2	p3	d4	p5	p6	p7	p8	p9	p10	p11	p12	p13	p14	
Code1B	26	02	20	20	07	1F	80	20	00	44	00	80	00	44	00	20	00	1F	80

The corresponding bit is 1 when printing and 0 when not printing.

EPSON	TITLE	TM-U200 series Specification (STANDARD)	SHEET REVISION	NO.	
			I	NEXT 71	SHEET 70

ESC * *m nL nH d1...dk*

[Name] Select bit-image mode

[Format] ASCII ESC * *m nL nH d1...dk*
 Hex 1B 2A *m nL nH d1...dk*
 Decimal 27 42 *m nL nH d1...dk*

[Range] $m = 0, 1$
 $0 \leq nL \leq 255$
 $0 \leq nH \leq 3$
 $0 \leq d \leq 255$

[Description] Selects a bit-image mode using *m* for the number of dots specified by *nL* and *nH*

- Divide the number of dots to be printed by 256. The interger answer is *nH* and the remainder is *nL*. Therefore, the number of dots in the horizontal direction is calculated by $nL + 256 \times nH$.
- If the bit-image data input exceeds the number of dots to be printed on a line, the excess data is ignored.
- *d* indicates the bit-image data. Set a corresponding bit to 1 to print a dot or to 0 to not print a dot.
- The bit-image modes selectable by *m* are as follows.

		Horizontal Direction		
<i>m</i>	No. of Vertical Dots	Dot Density	Adjacent Dot	Maximum number of dots
0	8	Single Density	Permitted	200
1	8	Double Density	Prohibited	400

[Notes]

- If the values of *m* and *nH* are out of the specified range, the following data is processed as normal data.
- After printing a bit image, the printer returns to normal data processing mode.

EPSON	TITLE	TM-U200 series Specification (STANDARD)	SHEET REVISION	NO.	
			1	NEXT 72	SHEET 71

• The relationship between the image data and the dots to be printed is as follows.

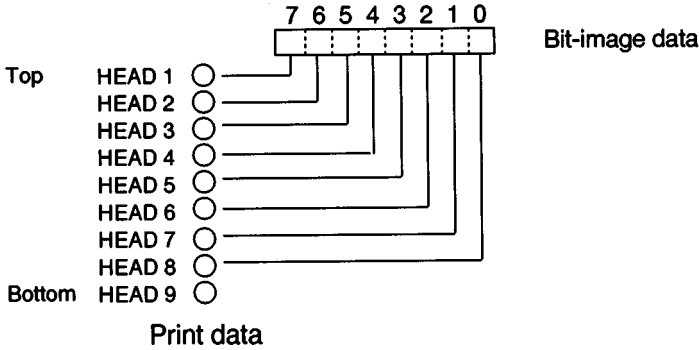

ESC – n

- [Name] Turn underline mode on/off
- [Format]

ASCII	ESC	–	<i>n</i>
Hex	1B	2D	<i>n</i>
Decimal	27	45	<i>n</i>
- [Range] *n* = 0, 1, 48, 49
- [Description] Turns underline mode on or off,
 - When *n* = 0 or 48, underline mode is turned off.
 - When *n* = 1 or 49, underline mode is turned on.
- [Notes]
 - Underlines can be printed for all characters, but not for the space set by **HT**.
 - This command and **ESC !** turn underline mode on or off in the same way.
 - If *n* is out of the specified range, this command is ignored.
 - The under line setting by this command does not affect the Kanji character printing.
- [Default] *n* = 0
- [Reference] **ESC !**

EPSON	TITLE	SHEET REVISION	NO.	
	TM-U200 series Specification (STANDARD)	I	NEXT 73	SHEET 72

Confidential

ESC 2

[Name]	Select default line spacing		
[Format]	ASCII	ESC	2
	Hex	1B	32
	Decimal	27	50
[Description]	Selects default (1/6-inch) line spacing.		
[Reference]	ESC 3		

ESC 3 *n*

[Name]	Set line spacing		
[Format]	ASCII	ESC	3 <i>n</i>
	Hex	1B	33 <i>n</i>
	Decimal	27	51 <i>n</i>
[Range]	$0 \leq n \leq 255$		
[Description]	Sets the line spacing to [$n \times (1/144)$] inches.		
[Default]	$n = 24$ (1/6 inch)		
[Reference]	ESC 2		

ESC <

[Name]	Return home		
[Format]	ASCII	ESC	<
	Hex	1B	3C
	Decimal	27	60
[Description]	Moves the print head to the standby position.		
[Notes]	<ul style="list-style-type: none">• The print head first moves to the left-most position, then to the right-most position, and then to the left-most position again.• The leftmost end is detected by the home position sensor.• Since the home position is detected when this command is executed, the printing position may shift after this command is executed.		

EPSON	TITLE TM-U200 series Specification (STANDARD)	SHEET REVISION 1	NO.	
			NEXT 74	SHEET 73

Confidential

ESC = n

[Name] Select device

[Format] ASCII ESC = n
Hex 1B 3D n
Decimal 27 61 n

[Range] $1 \leq n \leq 3$

[Description] Selects device to which host computer sends data, using n as follows:

Bit	Off/On	Hex	Decimal	Function
0	Off	00	0	Printer disabled.
	On	01	1	Printer enabled.
1	Off	00	0	Customer display disabled.
	On	02	2	Customer display enabled.
2	-	-	-	Undefined
3	-	-	-	Undefined
4	-	-	-	Undefined
5	-	-	-	Undefined
6	-	-	-	Undefined
7	-	-	-	Undefined

[Notes] • When the printer is disabled, it ignores all data except for error-recovery commands (**DLE EOT** and **DLE ENQ**) until it is enabled by this command.

[Default] $n = 1$

[Reference] **DLE EOT, DLE ENQ**

EPSON	TITLE TM-U200 series Specification (STANDARD)	SHEET REVISION 1	NO.	
			NEXT 75	SHEET 74

ESC ? *n*

[Name]	Cancel user-defined characters
[Format]	ASCII ESC ? <i>n</i> Hex 1B 3F <i>n</i> Decimal 27 63 <i>n</i>
[Range]	$32 \leq n \leq 126$
[Description]	Cancels user-defined characters.
[Notes]	<ul style="list-style-type: none"> * This command is valid only when the receive buffer capacity is 40 bytes (when DIP switch 1-2 is on). • This command cancels the pattern defined for the character code specified by <i>n</i>. After the user-defined characters is cancelled, the corresponding pattern for the internal character is printed. • This command deletes the defined pattern for the specified code in the character font selected by the "ESC !" command. • If a user-defined character has not been defined for the specified character code, the printer ignores this command.
[Reference]	ESC &, ESC %

ESC @

[Name]	Initialize printer
[Format]	ASCII ESC @ Hex 1B 40 Decimal 27 64
[Description]	Clears the data in the print buffer and resets the printer mode to the mode that was in effect when the power was turned on.
[Notes]	<ul style="list-style-type: none"> • The DIP switch settings are not checked again. • The data in the receive buffer is not cleared.

EPSON	TITLE	TM-U200 series Specification (STANDARD)	SHEET REVISION	NO.	
			1	NEXT 76	SHEET 75

ESC D *n1... nk NUL*

[Name]	Set horizontal tab positions															
[Format]	<table border="0"> <tr> <td>ASCII</td> <td>ESC</td> <td>D</td> <td><i>n1...nk</i></td> <td><i>NUL</i></td> </tr> <tr> <td>Hex</td> <td>1B</td> <td>44</td> <td><i>n1...nk</i></td> <td><i>00</i></td> </tr> <tr> <td>Decimal</td> <td>27</td> <td>68</td> <td><i>n1...nk</i></td> <td><i>0</i></td> </tr> </table>	ASCII	ESC	D	<i>n1...nk</i>	<i>NUL</i>	Hex	1B	44	<i>n1...nk</i>	<i>00</i>	Decimal	27	68	<i>n1...nk</i>	<i>0</i>
ASCII	ESC	D	<i>n1...nk</i>	<i>NUL</i>												
Hex	1B	44	<i>n1...nk</i>	<i>00</i>												
Decimal	27	68	<i>n1...nk</i>	<i>0</i>												
[Range]	$1 \leq n \leq 255$ $0 \leq k \leq 32$															
[Description]	<p>Sets horizontal tab positions.</p> <ul style="list-style-type: none"> • <i>n</i> specifies the column number (counted from the beginning of the line) for setting a horizontal tab position. • <i>k</i> indicates the total number of horizontal tab positions to be set. 															
[Notes]	<ul style="list-style-type: none"> * This command is valid only when the receive buffer capacity is 40 bytes (when DIP switch 1-2 is on). • The tab position is set at [character width x <i>n</i>] from the beginning of the line. The character width includes the right-side space of the character, and is twice the normal value when double-width is specified. • This command deletes horizontal tab positions that have already been set. • When "<i>n</i> = 8" has been set for the horizontal tab position, the printing position moves to the ninth digit when HT is executed. • Up to 32 tab positions can be set. Data exceeding 32 tab positions is processed as normal data. • Input <i><n>k</i> in ascending order and place a NUL code <00>H at the end when <i><n>k</i> is less than or equal to the preceding value <i><n>k-1</i>, tab setting is finished and the following data is processed as normal data. • ESC D NUL cancels all horizontal tab positions. • The previously specified horizontal tab positions do not change, even if the character width changes. 															
[Default]	The default tab positions are at intervals of 8 characters (columns 9, 17, 25, ...) for the font B (7 × 9).															
[Reference]	HT															

<h1 style="margin: 0;">EPSON</h1>	TITLE	TM-U200 series Specification (STANDARD)	SHEET REVISION	NO.	
			1	NEXT 77	SHEET 76

ESC E *n*

[Name]	Turn emphasized mode on/off
[Format]	ASCII ESC E <i>n</i> Hex 1B 45 <i>n</i> Decimal 27 69 <i>n</i>
[Range]	$0 \leq n \leq 255$
[Description]	Turns emphasized mode on or off. <ul style="list-style-type: none">• When the LSB of <i>n</i> is 0, emphasized mode is turned off.• When the LSB of <i>n</i> is 1, emphasized mode is turned on.
[Notes]	* 2-pass printing is slower in emphasized mode. <ul style="list-style-type: none">• Only the lowest bit of <i>n</i> is enabled.• The printer does not emphasize bit-images.• This command and ESC ! turn on and off emphasized mode in the same way. The last proceeded command becomes effective.• Printer output is the same in double-strike (ESC G) and in emphasized.• This command affects the alpha-numeric and Kanji character printing.
[Default]	<i>n</i> = 0
[Reference]	ESC ! , ESC G

ESC G *n*

[Name]	Turn double-strike mode on/off
[Format]	ASCII ESC G <i>n</i> Hex 1B 47 <i>n</i> Decimal 27 71 <i>n</i>
[Range]	$0 \leq n \leq 255$
[Description]	Turns double-strike mode on or off. <ul style="list-style-type: none">• When the LSB of <i>n</i> is 0, double-strike mode is turned off.• When the LSB of <i>n</i> is 1, double-strike mode is turned on.
[Notes]	* 2-pass printing is slower in double-strike mode. <ul style="list-style-type: none">• Only the lowest bit of <i>n</i> is enabled.• The printer does not double-strike for bit-images.• Printer output is the same in double-strike and in emphasized (ESC E).• This command affects the alpha-numeric and Kanji character printing.
[Default]	<i>n</i> = 0
[Reference]	ESC E

EPSON	TITLE	TM-U200 series Specification (STANDARD)	SHEET REVISION	NO.	
			I	NEXT 78	SHEET 77

ESC J *n*

[Name]	Print and feed paper												
[Format]	<table> <tr> <td>ASCII</td> <td>ESC</td> <td>J</td> <td><i>n</i></td> </tr> <tr> <td>Hex</td> <td>1B</td> <td>4A</td> <td><i>n</i></td> </tr> <tr> <td>Decimal</td> <td>27</td> <td>74</td> <td><i>n</i></td> </tr> </table>	ASCII	ESC	J	<i>n</i>	Hex	1B	4A	<i>n</i>	Decimal	27	74	<i>n</i>
ASCII	ESC	J	<i>n</i>										
Hex	1B	4A	<i>n</i>										
Decimal	27	74	<i>n</i>										
[Range]	$0 \leq n \leq 255$												
[Description]	Prints the data in the print buffer and feeds the paper [$n \times 0.176\text{mm}$ {1/144 inches}].												
[Notes]	<ul style="list-style-type: none"> • After printing is completed, this command sets the print starting position to the beginning of the line. • This command has no effect on the line feed amount set by the "ESC 2" command or the "ESC 3" command. 												
[Reference]	ESC K												

ESC K *n*

[Name]	Print and reverse feed												
[Format]	<table> <tr> <td>ASCII</td> <td>ESC</td> <td>K</td> <td><i>n</i></td> </tr> <tr> <td>Hex</td> <td>1B</td> <td>4B</td> <td><i>n</i></td> </tr> <tr> <td>Decimal</td> <td>27</td> <td>75</td> <td><i>n</i></td> </tr> </table>	ASCII	ESC	K	<i>n</i>	Hex	1B	4B	<i>n</i>	Decimal	27	75	<i>n</i>
ASCII	ESC	K	<i>n</i>										
Hex	1B	4B	<i>n</i>										
Decimal	27	75	<i>n</i>										
[Range]	$0 \leq n \leq 48$												
[Description]	Prints the data in the print buffer and feeds the paper [$n \times 0.176\text{mm}$ {1/144 inches}] in the reverse direction												
[Notes]	<ul style="list-style-type: none"> * This command must not be issued continuously more than two times. * Reverse direction paper feeding causes the following problems <ol style="list-style-type: none"> 1) Paper feed pitch is incorrect 2) Printer noise is louder than normal. 3) The paper may rub against the ribbon and become dirty. • If <i>n</i> is out of the specified range, the printer prints the data and does not feed the paper. 												
[Reference]	ESC J												

EPSON	TITLE	TM-U200 series Specification (STANDARD)	SHEET REVISION	NO.	
			I	NEXT 79	SHEET 78

Confidential

ESC R *n*

[Name] Select an international character set

[Format] ASCII ESC R *n*
Hex 1B 52 *n*
Decimal 27 82 *n*

[Range] $0 \leq n \leq 13$

[Description] Selects an international character set *n* from the following table:

<i>n</i>	Character set
0	U.S.A.
1	France
2	Germany
3	U.K.
4	Denmark I
5	Sweden
6	Italy
7	Spain I
8	Japan
9	Norway
10	Denmark II
11 (*)	Spain II
12 (*)	Latin America
13 (*)	Korea

(*) These character sets are not supported in the single-color printing model of the type D.

[Default] $n = 0$

[Reference] Section 3.2.9 Character Code Tables

EPSON	TITLE TM-U200 series Specification (STANDARD)	SHEET REVISION I	NO.	
			NEXT 80	SHEET 79

Confidential

ESC U *n*

[Name] Turn unidirectional printing mode on/off

[Format] ASCII ESC U *n*
Hex 1B 55 *n*
Decimal 27 85 *n*

[Range] $0 \leq n \leq 255$

[Description] Turns unidirectional printing mode on or off

When the LSB of *n* is 0, turn off unidirectional printing mode. (Turn bidirectional printing mode on.)

When the LSB of *n* is 1, turn on unidirectional printing mode and turn on bidirectional printing mode.

- [Notes]
- Only the lowest bit of *n* is enabled.
 - When unidirectional printing mode is turned on, the printer prints from left to right.
 - To avoid horizontal printing misalignment, unidirectional printing mode should be used.

[Default] $n = 0$

EPSON	TITLE TM-U200 series Specification (STANDARD)	SHEET REVISION I	NO.	
			NEXT 81	SHEET 80

Confidential

ESC a n

[Name] Select justification

[Format] ASCII ESC a *n*
 Hex 1B 61 *n*
 Decimal 27 97 *n*

[Range] $0 \leq n \leq 2, 48 \leq n \leq 50$

[Description] Aligns all the data in one line to the specified position.

n selects the type of justification as follows:

<i>n</i>	Justification
0, 48	Left justification
1, 49	Centering
2, 50	Right justification

- [Notes]
- The command is enabled only when input at the beginning of the line.
 - A portion of data skipped by means of **HT** is also target data for the justification function.

[Default] *n* = 0

[Example]

Left justification	Centering	Right justification
ABC ABCD ABCDE	ABC ABCD ABCDE	ABC ABCD ABCDE

ESC c 3 n

- [Name] Select paper detector(s) to output paper end signals
- [Format] ASCII ESC c 3 n
 Hex 1B 63 33 n
 Decimal 27 99 51 n
- [Range] $0 \leq n \leq 255$
- [Description] Selects paper detector(s) to output paper end signals, using n as follows:

Bit	Off/On	Hex	Decimal	Function
0	Off	00	0	Paper roll near end sensor disabled.
	On	01	1	Paper roll near end sensor enabled.
1	Off	00	0	Paper roll near end sensor disabled.
	On	02	2	Paper roll near end sensor enabled.
2	Off	00	0	Paper roll end detector disabled.
	On	04	4	Paper roll end detector enabled.
3	Off	00	0	Paper roll end detector disabled.
	On	08	8	Paper roll end detector enabled.
4	-	-	-	Undefined
5	-	-	-	Undefined
6	-	-	-	Undefined
7	-	-	-	Undefined

- [Notes]
- This command is available only with a parallel interface.
 - It is possible to select multiple detectors to output signals. Then, if any of the detectors detects a paper end, the paper end signal is output.
 - Detectors is switched when executing this command. Because of this, the paper-out signal switching may delay depending on the receive buffer state.
 - The paper near-end sensor is an option; therefore, if the sensor is not equipped, the sensor always detects that paper is installed, not near-end.
- [Default] $n = 15$

EPSON	TITLE	TM-U200 series Specification (STANDARD)	SHEET REVISION	NO.	
			I	NEXT 83	SHEET 82

Confidential

ESC c 4 n

[Name] Select paper sensor(s) to stop printing

[Format] ASCII ESC c 4 n
Hex 18 63 34 n
Decimal 27 99 52 n

[Range] $0 \leq n \leq 255$

[Description] Selects the paper sensor(s) used to stop printing when a paper-end is detected, using n as follows :

Bit	Off/On	Hex	Decimal	Function
0	Off	00	0	Paper roll near-end sensor disabled.
	On	01	1	Paper roll near-end sensor enabled.
1	Off	00	0	Paper roll near-end sensor disabled.
	On	02	2	Paper roll near-end sensor enabled.
2	-	-	-	Undefined
3	-	-	-	Undefined
4	-	-	-	Undefined
5	-	-	-	Undefined
6	-	-	-	Undefined
7	-	-	-	Undefined

- [Notes]
- When a paper end is detected, printing stops after printing the current line and feeding the paper.
 - The printer goes off-line after printing stops.
 - The paper roll near-end sensor is an option, therefore, if the paper roll near-end sensor is enabled by this command when the sensor is not equipped, it does not stop printing.
 - The paper roll near-end sensor is enabled when either bit 0 or 1 is 1.
 - The paper roll end sensor is a sensor which is always used to make an effective to stop printing.

[Default] $n = 0$

EPSON	TITLE TM-U200 series Specification (STANDARD)	SHEET REVISION I	NO.	
			NEXT 84	SHEET 83

ESC c 5 n

[Name]	Enable/disable panel buttons			
[Format]	ASCII	ESC	c	5 n
	Hex	1B	63	35 n
	Decimal	27	99	53 n
[Range]	0 ≤ n ≤ 255			
[Description]	Enables or disables the panel buttons.			
	<ul style="list-style-type: none"> • When the LSB of n is 0, the panel buttons are enabled. • When the LSB of n is 1, the panel buttons are disabled. 			
[Notes]	<ul style="list-style-type: none"> • Only the least significant bit of "n" is valid. • When the panel buttons are disabled, no buttons on the panel are usable. If "disabled" is set, the paper feed switch no longer functions. However, when loading roll paper, if the paper loading wait time has been set with "GS z 0", the paper feed switch can be used to feed the paper forward within the set time. • For this printer, "panel switch" refers to the feed button. 			
[Default]	n = 0			

ESC d n

[Name]	Print and feed n lines			
[Format]	ASCII	ESC	d	n
	Hex	1B	64	n
	Decimal	27	100	n
[Range]	0 ≤ n ≤ 255			
[Description]	Prints the data in the print buffer and feeds n lines.			
[Notes]	<ul style="list-style-type: none"> • This command sets the print starting position to the beginning of the line. • The maximum paper feed amount is 40 inches. If the specified amount exceeds 40 inches, the paper feed amount is automatically set to 40 inches. • This command has no effect on the line feed amount set by the "ESC 2" command or the "ESC 3" command. 			
[Reference]	ESC e			

EPSON	TITLE	SHEET REVISION	NO.	
	TM-U200 series Specification (STANDARD)	I	NEXT 85	SHEET 84

ESC e n

[Name]	Print and reverse feed n lines
[Format]	ASCII ESC e n Hex 1B 65 n Decimal 27 101 n
[Range]	$0 \leq n \leq 2$
[Description]	Prints the data in the print buffer and feeds n lines in the reverse direction.
[Notes]	<ul style="list-style-type: none"> * This command must not be issued continuously more than two times. * Reverse direction paper feeding causes the following problems: <ol style="list-style-type: none"> 1) Paper feed pitch is incorrect. 2) Printer noise is louder than normal. 3) The paper may rub against the ribbon and become dirty. • If n is out of the specified range if the paper feed amount exceeds 8.467 mm {48/144 inches}, the printer prints the data and does not feed the paper.
[Reference]	ESC d

ESC p m t1 t2

[Name]	Generate pulse
[Format]	ASCII ESC p m $t1$ $t2$ Hex 1B 70 m $t1$ $t2$ Decimal 27 112 m $t1$ $t2$
[Range]	$m = 0, 1, 48, 49$ $0 \leq t1 \leq 255$ $0 \leq t2 \leq 255$
[Description]	Outputs the pulse specified by $t1$ and $t2$ to connector pin m as follows:

m	Connector pin
0, 48	Drawer kick-out connector pin 2
1, 49	Drawer kick-out connector pin 5

[Notes]	<ul style="list-style-type: none"> • The pulse ON time is [$t1 \times 2$] ms and the OFF time is [$t2 \times 2$] ms. • When $t2 < t1$, the printer processes $t1 \times 2$ ms. • If $t2$ is less than 50, $t2$ is assumed to be equal to 50.
[Reference]	Section 2.2.3 drawer kicc-out connector, Appendix D

EPSON	TITLE	SHEET REVISION	NO.	
	TM-U200 series Specification (STANDARD)	I	NEXT 86	SHEET 85

Confidential

ESC r n

[Name] Select print color

[Format] ASCII ESC r n
Hex 1B 72 n
Decimal 27 114 n

[Range] n = 0, 1, 48, 49

[Description] Selects the print color.

n	Selected color
0, 48	Black
1, 49	Red

- [Notes]
- Valid only when input at the beginning of a line.
 - This command is effective only for the two-color printing model.

[Default] n = 0

EPSON	TITLE TM-U200 series Specification (STANDARD)	SHEET REVISION I	NO.	
			NEXT 87	SHEET 86

Confidential

ESC t n

[Name]	Select character code table
[Format]	ASCII ESC t <i>n</i> Hex 1B 74 <i>n</i> Decimal 27 116 <i>n</i>
[Range]	$0 \leq n \leq 8$, $20 \leq n \leq 26$, $n = 254, 255$
[Description]	Selects a page <i>n</i> from the character code table.

<i>n</i>	Page
0	PC4.7 [U.S.A., Standard Europe]
1	Katakana
2	PC850 [Multilingual]
3	PC860 [Portuguese]
4	PC863 [Canadian-French]
5	PC865 [Nordic]
6	Hiragana
7	One-pass printing Kanji characters
8	One-pass printing Kanji characters
20 (*)	Thai character code 42
21 (*)	Thai character code 11
22 (*)	Thai character code 13
23 (*)	Thai character code 14
24 (*)	Thai character code 16
25 (*)	Thai character code 17
26 (*)	Thai character code 18
254	Space page
255	Space page

Character code table ($n = 6, 7,$ and 8) is available only on the Japanese Kanji supporting model.

(*): The character code table ($n = 20$ through 26) is available only on TM-U200AM (Thai character supporting model).

[Default]	$n = 0$ For Thai character supporting model: $n = 20$
[Reference]	Section 3.2 Character Code Tables, Appendix F

EPSON	TITLE TM-U200 series Specification (STANDARD)	SHEET REVISION I	NO.	
			NEXT 88	SHEET 87

ESC { n

[Name] Turns on/off upside-down printing mode

[Format] ASCII ESC { n
 Hex 1B 7B n
 Decimal 27 123 n

[Range] $0 \leq n \leq 255$

[Description] Turns upside-down printing mode on or off.

- When the LSB of *n* is 0, upside-down printing mode is turned off.
- When the LSB of *n* is 1, upside-down printing mode is turned on.

[Notes]

- Only the lowest bit of *n* is effective.
- This command is enabled only when input at the beginning of a line.
- In upside-down printing mode, the printer rotates the line to be printed by 180° and then prints it.

[Default] $n = 0$

[Example]

Upside-down printing mode is turned off



Upside-down printing mode is turned on

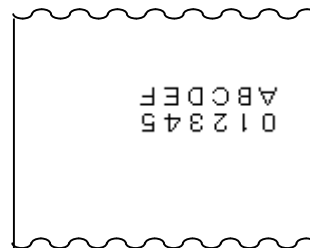

Paper feed direction

EPSON	TITLE	TM-U200 series Specification (STANDARD)	SHEET REVISION	NO.	
			I	NEXT 89	SHEET 88

Confidential

GS (A *pL pH n m*)

[Name]	Execute test print							
[Format]	ASCII	GS	(A	<i>pL</i>	<i>pH</i>	<i>n</i>	<i>m</i>
	Hex	1D	28	41	<i>pL</i>	<i>pH</i>	<i>n</i>	<i>m</i>
	Decimal	29	40	65	<i>pL</i>	<i>pH</i>	<i>n</i>	<i>m</i>

[Range] $(pL+(pH \times 256))=2$ (where $pL=2, pH=0$)
 $0 \leq n \leq 2, 48 \leq n \leq 50$
 $1 \leq m \leq 3, 49 \leq m \leq 51$

- [Description]
- Executes a test print with a specified test pattern on a specified paper.
 - pL* and *pH* specifies the number of the parameter such as *n*, *m* to $(pL + (pH \times 256))$ bytes.

n specifies the paper to be tested.

<i>n</i>	Paper
0, 48	Basic sheet (paper roll)
1, 49	Paper roll
2, 50	

m specifies a test pattern.

<i>m</i>	Test pattern
1, 49	Hexadecimal dump
2, 50	Printer status print
3, 51	Rolling pattern print

- [Description]
- * When the hexadecimal dump is printed by this command, the data which is transmitted after the command may not be printed because the printer clears the receive buffer. To avoid this, transmit data from the host after the printer prints the starting message of the hexadecimal dump.
 - This command is enabled only when processed at the beginning of a line in standard mode.
 - After the test print is finished, the printer resets itself automatically. Therefore, the already-defined data before this command is executed, such as an user-defined characters, downloaded bit image, and macro, becomes undefined, and the receive buffer and print buffer are cleared, and each setting returns to the default value. The printer also re-reads the DIP switch settings.
 - At the end of the test print, the printer cuts the paper, or ejects the cut sheet when the cut sheet is selected.
 - The printer goes BUSY while this command is executed.

EPSON	TITLE	TM-U200 series Specification (STANDARD)	SHEET REVISION	NO.	
			I	NEXT 90	SHEET 89

GS I n

[Name] Transmit printer ID

[Format] ASCII GS I n
 Hex 1D 49 n
 Decimal 29 73 n

[Range] $1 \leq n \leq 3, 49 \leq n \leq 51, 65 \leq n \leq 69$

[Function] Transmits the printer ID specified by *n* as follows:

<i>n</i>	Printer ID	Specification	ID (hexadecimal)
1, 49	Printer model ID	TM-U200 series	0D
2, 50	Type ID	See table below.	
3, 51	ROM version ID	ROM version	
65	Firmware version	Depends on Firmware version.	
66	Manufacturer	EPSON	
67	Printer name	TM - U200	
68	Serial number	Depends on serial number.	
69	Supporting multilingual characters	Japan model: KANJI JAPANESE China model: CHINA GB2312 Taiwan model: TAIWAN BIG-5 Thai model: THAI 3 PASS	

n = 2, Type ID

Bit	Off/On	Hex	Decimal	Function
0	Off	00	0	Two-byte character code not supported.
	On	01	1	Two-byte character code supported.
1	Off	00	0	Auto cutter not equipped.
	On	02	2	Auto cutter equipped.
2	-	-	-	Undefined.
3	-	-	-	Undefined.
4	Off	00	0	Not used. Fixed to Off.
5	-	-	-	Undefined.
6	-	-	-	Undefined.
7	Off	00	0	Not used. Fixed to Off.

- [Notes]
- When DTR/DSR control is selected, the printer transmits only 1 byte (Printer ID) after confirming that the host is ready to receive data. If the host computer is not ready to receive data, the printer waits until the host is ready.
 - When XON/XOFF control is selected, the printer transmits only 1 byte (Printer ID) without confirming the condition whether the host is ready to receive data or not.
 - The printer ID is transmitted when the data in the receive buffer is developed. Therefore, there may be a time lag between receiving this command and transmitting the status, depending on the receive buffer status.
 - When Auto Status Back (ASB) is enabled using **GS a**, the status transmitted by **GS I** and the ASB status must be differentiated by using the table in Appendix E.

EPSON	TITLE	SHEET REVISION	NO.	
	TM-U200 series Specification (STANDARD)	I	NEXT 91	SHEET 90

Confidential

- When the printer ID transmission is specified with ($65 \leq n \leq 69$), the following contents are transmitted:

Header: Hexadecimal = 5FH / Decimal = 95 (1 byte)

Data: Printer information

NUL: Hexadecimal = 00H / Decimal = 0 (1 byte)

After the data is ready to be transmitted, the printer executes the following process.

- ① Executes READY to BUSY. If it is already BUSY, the printer executes nothing.
- ② Transmits [Header + Data + NUL].
- ③ Executes BUSY to READY. If it is already BUSY from any other cause, the printer executes nothing.

[Reference] Appendix E

① **GS V m**

② **GS V m n**

[Name] Feeds paper for cutting position.

[Format]

① ASCII	GS	V	m	
	Hex	1D	56	m
	Decimal	29	86	m
② ASCII	GS	V	m	n
	Hex	1D	56	m n
	Decimal	29	86	m n

[Range] ① $m = 1, 49$ ② $m = 66, 0 \leq n \leq 255$

[Description] Feeds paper for cutting position as follows;

<i>m</i>	Print mode
1, 49	Partial cut (one portion left uncut)
66	Feeds paper for (cutting position + [$n \times 0.176$ mm {1/144inches}]), and partial cut.

- [Notes]
- This command is effective only at the beginning of a line.
 - Cutting position differs on each model.
 Type A/AM/B: Position of the auto cutter
 Type D: Position of the manual cutter

[Notes for ①] • Type D model ignores this command.

- [Notes for ②]
- When $n = 0$, the printer feeds the paper to the cutting position.
 - When $n \neq 0$, the printer feeds the paper to (cutting position + [$n \times 0.176$ mm {1/144 inches}]).
 - Type D model executes the paper feeding only, and does not execute the paper cutting.

EPSON	TITLE	SHEET REVISION	NO.	
	TM-U200 series Specification (STANDARD)	1	NEXT 92	SHEET 91

GS a n

[Name] Enable/Disable Automatic Status Back

[Format] ASCII GS a n
 Hex 1D 61 n
 Decimal 29 97 n

[Range] $0 \leq n \leq 255$

[Description] Enables or disables ASB and specifies the status items to include, using *n* as follows:

Bit	Off/On	Hex	Decimal	Status for ASB
0	Off	00	0	Drawer kick-out connector pin 3 status disabled.
	On	01	1	Drawer kick-out connector pin 3 status enabled.
1	Off	00	0	On-line/off-line disabled.
	On	02	2	On-line/off-line enabled
2	Off	00	0	Error status disabled.
	On	04	4	Error status enabled.
3	Off	00	0	Paper roll sensor status disabled.
	On	08	8	Paper roll sensor status enabled.
4	-	-	-	Undefined.
5	-	-	-	Undefined.
6	-	-	-	Undefined.
7	-	-	-	Undefined.

- [Notes]
- Even if only one of the statuses is enabled, the status is sent when this command is executed. Subsequently, whenever the state of a valid status changes, that status is sent. In this case, because the current state is shown for each status, there is a possibility of a state change for a status for which ASB is not enabled.
 - If all statuses are disabled, the Automatic Status Back (ASB) function is disabled.
 - When transmitting a status, the printer transmits only four bytes without confirming the condition of the DSR signal.
 - Four bytes of status data must be consecutive, except for XOFF code.
 - This command is executed when the data in the receive buffer is developed. Therefore, there may be a time lag between receiving this command and transmitting the status, depending on the receive buffer status.
 - When the printer is disabled by **ESC =** (Select peripheral device), this command is disabled but ASB is not disabled.
 - When using **DLE EOT**, **GS I**, or **GS r**, the status transmitted by this command, the ASB information, and the status transmitted by other commands must be differentiated by using the table in Appendix E.
 - The status to be transmitted are as follows:

EPSON	TITLE TM-U200 series Specification (STANDARD)	SHEET REVISION I	NO.	
			NEXT 93	SHEET 92

Confidential

First byte (printer information)

Bit	Off/On	Hex	Decimal	Status for ASB
0	Off	00	0	Not used. Fixed to Off.
1	Off	00	0	Not used. Fixed to Off.
2	Off	00	0	Drawer kick-out connector pin 3 is LOW
	On	04	4	Drawer kick-out connector pin 3 is HIGH.
3	Off	00	0	On-line.
	On	08	8	Off-line.
4	On	10	16	Not used. Fixed to On.
5	-	-	-	Undefined.
6	Off	00	0	Paper is not being fed by the paper feed button.
	On	40	64	Paper is being fed by the paper feed button.
7	Off	00	0	Not used. Fixed to Off.

Second byte (printer information)

Bit	Off/On	Hex	Decimal	Status for ASB
0	Off	00	0	Not waiting for on-line recovery.
	On	01	1	Waiting for on-line recovery.
1	-	-	-	Undefined.
2	Off	00	0	No mechanical error.
	On	04	4	Mechanical error.
3	Off	00	0	No auto cutter error.
	On	08	8	Auto cutter error occurred.
4	Off	00	0	Not used. Fixed to Off.
5	Off	00	0	No unrecoverable error.
	On	20	32	Unrecoverable error.
6	Off	00	0	No temporary abnormality of the print head temperature.
	On	40	64	Temporary abnormality of the print head temperature.
7	Off	00	0	Not used. Fixed to Off.

Third byte (paper sensor information)

Bit	Off/On	Hex	Decimal	Status for ASB
0,1	Off	00	0	Paper near-end sensor: paper adequate.
	On	(03)	(3)	Paper near-end sensor: paper near end.
2,3	Off	00	0	Paper end sensor: paper present.
	On	0C	12	Paper end sensor: no paper present.
4	Off	00	0	Not used. Fixed to Off.
5	-	-	-	Undefined.
6	-	-	-	Undefined.
7	Off	00	0	Not used. Fixed to Off.

Bits 0 and 1: The "paper roll near end" sensor is an option; on units that do not have this sensor, the "paper roll near end" sensor always indicates that paper is present (bits 0 and 1 = 1), whether or not it actually is.

EPSON	TITLE TM-U200 series Specification (STANDARD)	SHEET REVISION I	NO.	
			NEXT 94	SHEET 93

Confidential

Fourth byte (paper sensor information)

Bit	Off/On	Hex	Decimal	Status for ASB
0	-	-	-	Undefined.
1	-	-	-	Undefined.
2	-	-	-	Undefined.
3	-	-	-	Undefined.
4	Off	00	0	Not used. Fixed to Off.
5	-	-	-	Undefined.
6	-	-	-	Undefined.
7	Off	00	0	Not used. Fixed to Off.

[Default] $n = 0$ when DIP SW 1-8 is off, $n = 2$ when DIP SW 1-8 is on.

[Reference] **DLE EOT, GS r**, 3.5.1 Error types, Appendix E

GS r n

[Name] Transmit status

[Format] ASCII GS r n
Hex 1D 72 n
Decimal 29 114 n

[Range] $1 \leq n \leq 2$, $49 \leq n \leq 50$

[Description] Transmits the status specified by n as, follows:

n	Function
1, 49	Transmits paper sensor status
2, 50	Transmits drawer kick-out connector status

- [Notes]
- When DTR/DSR control is selected, the printer transmits only 1 byte after confirming the host is ready to receive data . If the host computer is not ready to receive data, the printer waits until the host is ready.
 - When XON/XOFF control is selected, the printer transmits only 1 byte without confirming the condition whether the printer is ready to receive data or not.
 - This command is executed when the data in the receive buffer is developed. Therefore, there may be a time lag between receiving this command and transmitting the status, depending on the receive buffer status.
 - When Auto Status Back (ASB) is enabled using **GS a**, the status transmitted by **GS r** and the ASB status must be differentiated by using the table in Appendix E.
 - The status types to be transmitted are shown below:

EPSON	TITLE TM-U200 series Specification (STANDARD)	SHEET REVISION I	NO.	
			NEXT 95	SHEET 94

Confidential

Paper sensor status ($n = 1,49$)

Bit	Off/On	Hex	Decimal	Status for ASB
0,1	Off	00	0	Paper near-end sensor: paper present.
	On	(03)	(3)	Paper near-end sensor: paper near end.
2,3	Off	00	0	Paper end sensor: paper present.
	On	0C	12	Paper end sensor: no paper present.
4	Off	00	0	Not used. Fixed to Off.
5	-	-	-	Undefined.
6	-	-	-	Undefined.
7	Off	00	0	Not used. Fixed to Off.

Bits 0 and 1: The "paper roll near end" sensor is an option; on units that do not have this sensor, the "paper roll near end" sensor always indicates that paper is present (bits 0 and 1 = 1), whether or not it actually is.

Drawer kick-out connector status ($n = 2, 50$):

Bit	Off/On	Hex	Decimal	Status for ASB
0	Off	00	0	Drawer kick-out connector pin 3 is LOW.
	On	01	1	Drawer kick-out connector pin 3 is HIGH.
1	-	-	-	Undefined.
2	-	-	-	Undefined.
3	-	-	-	Undefined.
4	Off	00	0	Not used. Fixed to Off.
5	-	-	-	Undefined.
6	-	-	-	Undefined.
7	Off	00	0	Not used. Fixed to Off.

[Reference] **DLE EOT, GS a**, Appendix E

EPSON	TITLE TM-U200 series Specification (STANDARD)	SHEET REVISION I	NO.	
			NEXT 96	SHEET 95

GS z 0 t1 t2

[Name] Setting of on-line recovery wait time

[Format] ASCII GS z 0 t1 t2
 Hex 1D 7A 30 t1 t2
 Decimal 29 122 48 t1 t2

[Range] $0 \leq t1 \leq 255$
 $0 \leq t2 \leq 255$

[Function] Sets the paper loading wait time (from paper insertion to recovery confirmation state) to approximately ($t1 \times 500$ msec.) and the recovery confirmation time (from end of the paper loading wait time to on-line recovery) to approximately ($t2 \times 500$ msec.).

- When $t1 = 0$, the printer enters the recovery confirmation state as soon as the paper is inserted.
- When $t2 = 0$, the recovery confirmation time is cancelled.

[Notes] • When the printer has gone off-line because printing stopped due to a lack of paper, it re-enters on-line operation once the set times elapse after paper loading is completed.

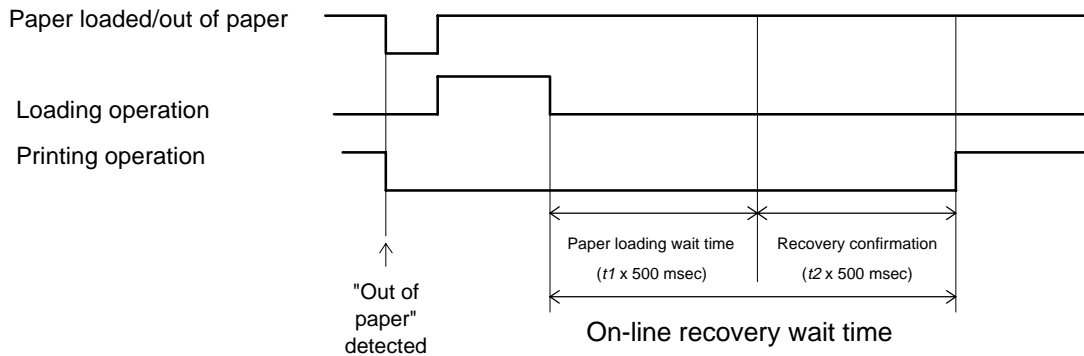

- Approximately ($t1 \times 500$ msec.) after the paper is inserted and loaded, the printer enters the recovery confirmation state. This interval is the paper loading wait time. In the paper loading wait state, pressing the paper feed switch feeds the paper forward. In addition, in the paper loading wait state, recovery to the on-line status is possible only by executing **DLE ENQ 0**. After the paper loading wait time elapses, the printer enters the recovery confirmation state.
- If the paper is fed forward by pressing the paper feed switch during the paper loading wait time, the time during which the paper is being fed is not counted as part of the paper loading wait time.

EPSON	TITLE	TM-U200 series Specification (STANDARD)	SHEET REVISION	NO.	
			I	NEXT 97	SHEET 96

Confidential

- Approximately ($t2 \times 500$ msec.) after the end of the paper loading wait time, the printer enters the on-line state. This interval is the recovery confirmation time. While the printer is in the recovery confirmation state, the PAPER OUT LED flashes. In the recovery confirmation state, it is possible to re-enter the on-line state by executing **DLE ENQ 0**, by allowing the recovery confirmation time to elapse, or by pressing the paper feed switch.
- The paper feed switch cannot be used to feed the paper forward during the recovery confirmation time.
- When $t2 = 0$ and the PAPER OUT LED is flashing, re-entering the on-line state is possible by executing **DLE ENQ 0** or by pressing the paper feed switch.
- If the roll paper "near end" sensor is mounted, and "printing stop" is enabled for the roll paper "near end" sensor by **ESC c 4** command, the printer begins waiting for paper to be loaded once the roll paper "near end" sensor and the roll paper detector both detect paper.
- If the roll paper detector detects the "out of paper" state while the printer is waiting for on-line recovery, the printer re-enters the roll paper insertion wait state.
- The printer begins waiting for paper to be loaded once the roll paper "near end" sensor detects paper.

[Default] For type A/AM: $t1 = 0, t2 = 1$
 For type B/D: $t1 = 6, t2 = 0$

[Reference] **DLE EOT, DLE ENQ, GS a**

EPSON	TITLE TM-U200 series Specification (STANDARD)	SHEET REVISION I	NO.	
			NEXT 98	SHEET 97

FS ! *n*

[Name] Set print mode(s) for Kanji characters

[Format] ASCII FS ! *n*
 Hex 1X 21 *n*
 Decimal 28 33 *n*

[Range] $0 \leq n \leq 255$

[Description] Sets the print mode for Kanji characters, using *n* as follows:

Bit	Off/On	Hex	Decimal	Status for ASB
0	-	-	-	Undefined.
1	-	-	-	Undefined.
2	Off	00	0	Double width mode disabled.
	On	04	4	Double width mode enabled.
3	Off	00	0	Double height mode disabled.
	On	08	8	Double height mode enabled.
4	-	-	-	Undefined.
5	-	-	-	Undefined.
6	-	-	-	Undefined.
7	Off	00	0	Underline mode disabled.
	On	80	128	Underline mode enabled.

- [Notes]
- This command is valid only Japanese Kanji model, Chinese Kanji model, and Taiwanese Kanji model.
 - When both double-width and double-height modes are set (including right- and left-side character spacing), quadruple-size characters are printed.
 - The printer can underline all characters (including right- and left-side character spacing), but cannot underline the space set by **HT**.

[Default] $n = 0$

[Reference] **FS -**, **FS W**

EPSON	TITLE	TM-U200 series Specification (STANDARD)	SHEET REVISION	NO.	
			1	NEXT 99	SHEET 98

FS &

[Name]	Select Kanji character mode
[Format]	ASCII FS & Hex 1C 26 Decimal 28 38
[Description]	Selects Kanji character mode.
[Notes]	For Japanese Kanji supporting model: <ul style="list-style-type: none"> • This command is effective only when the JIS code system is selected. • When the Kanji character mode is selected, the printer processes each two byte as Kanji character code. • Kanji codes are processed in the order of the first byte and second byte. • Kanji character mode is not selected when the power is turned on. • Using FS C, the Kanji character code system is selected. For Chinese/Taiwanese Kanji supporting model: <ul style="list-style-type: none"> • When the kanji character mode is selected, the printer checks whether the code is for Kanji or not, then processed the first byte and the second byte if the code is for Kanji. • Kanji codes are processed in the order of the first byte and second byte. • Kanji character mode is selected when the power is turned on.
[Reference]	FS ., FS C

FS – *n*

[Name]	Turn underline mode on/off for Kanji characters						
[Format]	ASCII FS – <i>n</i> Hex 1C 2D <i>n</i> Decimal 28 45 <i>n</i>						
[Range]	$0 \leq n \leq 1$						
[Description]	Turns underline mode for Kanji characters on or off, based on the following values of <i>n</i> :						
	<table border="1" style="width: 100%; border-collapse: collapse;"> <thead> <tr> <th style="text-align: center;"><i>n</i></th> <th style="text-align: center;">Function</th> </tr> </thead> <tbody> <tr> <td style="text-align: center;">0</td> <td>Turns off underline mode for Kanji characters</td> </tr> <tr> <td style="text-align: center;">1</td> <td>Turns on underline mode for Kanji characters (1-dot thick)</td> </tr> </tbody> </table>	<i>n</i>	Function	0	Turns off underline mode for Kanji characters	1	Turns on underline mode for Kanji characters (1-dot thick)
<i>n</i>	Function						
0	Turns off underline mode for Kanji characters						
1	Turns on underline mode for Kanji characters (1-dot thick)						
[Notes]	<ul style="list-style-type: none"> • This command is valid only for Japanese Kanji model, Chinese Kanji model, and Taiwanese Kanji model. • The printer can underline all characters (including right- and left-side character spacing), but cannot underline the space set by HT. 						
[Default]	<i>n</i> = 0						
[Reference]	FS !						

EPSON	TITLE	SHEET REVISION	NO.	
	TM-U200 series Specification (STANDARD)	I	NEXT 100	SHEET 99

FS .

[Name]	Cancel Kanji character mode
[Format]	ASCII FS . Hex 1C 2E Decimal 28 46
[Description]	Cancels Kanji character mode.
[Notes]	For Japanese Kanji supporting model: <ul style="list-style-type: none"> • This command is effective only when the JIS code system is selected. • When the Kanji character mode is not selected, all character codes are processed one byte at a time as ASCII code. • Kanji character mode is not selected when the power is turned on. For Chinese/Taiwanese Kanji supporting model: <ul style="list-style-type: none"> • When the Kanji character mode is not selected, all character codes are processed one byte at a time as ASCII code. • Kanji character mode is selected when the power is turned on.
[Reference]	FS &, FS C

FS 2 *c1 c2 d1...dk*

[Name]	Define user-defined Kanji characters
[Format]	ASCII FS 2 <i>c1</i> <i>c2</i> <i>d1...dk</i> Hex 1C 32 <i>c1</i> <i>c2</i> <i>d1...dk</i> Decimal 28 50 <i>c1</i> <i>c2</i> <i>d1...dk</i>
[Range]	<i>c1</i> and <i>c2</i> indicate character codes for the defined characters. The range of values for <i>c1</i> and <i>c2</i> differ depending on the character code system used.

Model type	<i>c1</i>	<i>c2</i>
Japanese Kanji supporting model (JIS code system)	<i>c1</i> = 77H	21H ≤ <i>c2</i> ≤ 7EH
Japanese Kanji supporting model (SHIFT-JIS code system)	<i>c1</i> = ECH	40H ≤ <i>c2</i> ≤ 7EH 80H ≤ <i>c2</i> ≤ 9EH
Chinese Kanji supporting model	<i>c1</i> = FEH	A1H ≤ <i>c2</i> ≤ FEH
Taiwanese Kanji supporting model	<i>c1</i> = FEH	A1H ≤ <i>c2</i> ≤ FEH

$0 \leq d \leq 255$
 $k = 32$

[Description]	<ul style="list-style-type: none"> • Defines user-defined Kanji characters for the character codes specified by <i>c1</i> and <i>c2</i>.
[Notes]	<ul style="list-style-type: none"> * This command is valid only when the receive buffer capacity is 40 bytes (when DIP switch 1-2 is on). • This command is valid only for Japanese Kanji model, Chinese Kanji model, and Taiwanese Kanji model. • <i>c1</i> and <i>c2</i> indicate character codes for the defined characters. The range of values for <i>c1</i> and <i>c2</i> differ depending on the character code system used.

EPSON	TITLE	SHEET REVISION	NO.	
	TM-U200 series Specification (STANDARD)	I	NEXT 101	SHEET 100

Confidential

- The *d* is the dot data for the characters. The number of defined data by *d* is 32 bytes which consists of 2 bytes for vertical × 16 dots.
- When the user-defined characters are defined, it is possible to redefine the defined Kanji character codes but not to define new Kanji character codes.
- The *d* is the dot data for the characters. Example is shown in the following page.
- After user-defined characters are defined, they are available until; another definition is mode; **ESC @**, **FS ?** is executed: the printer is reset; or the power is turned off.

[Default] All spaces.
 [Reference] **FS ?**, **FS C**
 <Example>

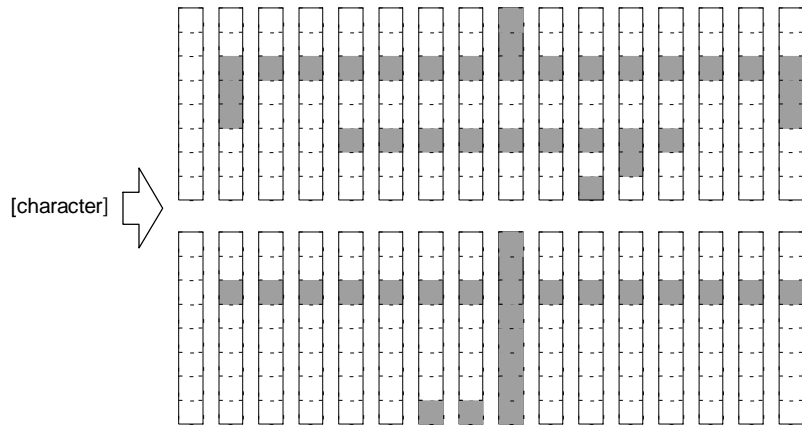
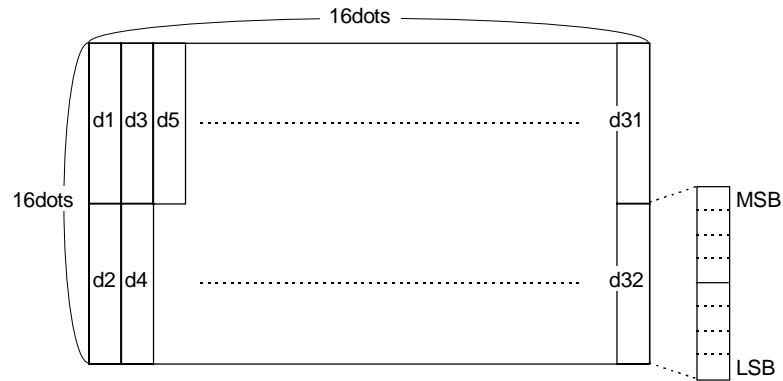

When the dot pattern for JIS code <7721>H is defined as shown above.

	FS	2	c1	c2	d1	d2	d3	d4	d5	d6	d7	d8	d9	d10	d11	d12	
Code (Hex)	IC	32	77	21	00	00	38	20	20	20	20	20	24	20	24	20	
	d13	d14	d15	d16	d17	d18	d19	d20	d21	d22	d23	d24	d25	d26	d27	d28	d29
	24	21	24	21	E4	FF	24	20	25	20	26	20	24	20	20	20	20
	d30	d31	d32														
	20	38	20														

The corresponding bit is 1 when printing and 0 when not printing.

EPSON	TITLE	TM-U200 series Specification (STANDARD)	SHEET REVISION	NO.	
			I	NEXT 102	SHEET 101

FS ? c1 c2

[Name] Chancel user-defined Kanji characters

[Format] ASCII FS ? c1 c2
 Hex 1C 3F c1 c2
 Decimal 28 63 c1 c2

[Range] c1 and c2 indicate character codes for the defined characters. The range of values for c1 and c2 differ depending on the character code system used.

Model type	c1	c2
Japanese Kanji supporting model (JIS code system)	c1 = 77H	21H ≤ c2 ≤ 7EH
Japanese Kanji supporting model (SHIFT-JIS code system)	c1 = ECH	40H ≤ c2 ≤ 7EH 80H ≤ c2 ≤ 9EH
Chinese Kanji supporting model	c1 = FEH	A1H ≤ c2 ≤ FEH
Taiwanese Kanji supporting model	c1 = FEH	A1H ≤ c2 ≤ FEH

[Description] Cancels user-defined characters.

- [Notes]
- * This command is valid only when the receive buffer capacity is 40 bytes (when DIP switch 1-2 is on).
 - This command cancels the pattern defined for the Kanji character code specified by c1 and c2. After the user-defined Kanji characters is cancelled, the space character is printed.
 - If a user-defined Kanji character has not been defined for the specified character code, the printer ignores this command.

[Reference] **FS 2, FS C**

FS C n

[Name] Select Kanji character code system

[Format] ASCII FS C n
 Hex 1C 43 n
 Decimal 28 67 n

[Range] n = 0, 1

[Description] Selects a Kanji character code system, based on the following values of n:

n	Kanji System
0	JIS code
1	SHIFT JIS code

- [Notes]
- This command is effective only for Japanese Kanji supporting model.
 - In the JIS code system, the following codes are available:
 Primary byte: <21>H to <7E>H
 Secondary byte: <21>H to <7E>H
 - In the SHIFT JIS code system, the following codes are available:
 Primary byte: <81>H to <9F>H and <E0>H to <EF>H
 Secondary byte: <40>H to <7E>H and <80>H to <FC>H

[Default] n = 0

EPSON	TITLE	SHEET REVISION	NO.	
	TM-U200 series Specification (STANDARD)	1	NEXT 103	SHEET 102

FS S *n1 n2*

[Name]	Set left- and right-side Kanji character spacing				
[Format]	ASCII	FS	S	<i>n1</i>	<i>n2</i>
	Hex	1C	53	<i>n1</i>	<i>n2</i>
	Decimal	28	83	<i>n1</i>	<i>n2</i>
[Range]	0 ≤ <i>n1</i> ≤ 32 0 ≤ <i>n2</i> ≤ 32				
[Description]	Sets left- and right-side Kanji character spacing <i>n1</i> and <i>n2</i> , respectively.				
[Notes]	<ul style="list-style-type: none"> • This command is valid only for Japanese Kanji model, Chinese Kanji model, and Taiwanese Kanji model. • When double-width mode is set, the left- and right-side character spacing is twice the normal value. • The Kanji character spacing is set in half-dot units. 				
[Default]	<i>n1</i> = 0, <i>n2</i> = 0				

FS W *n*

[Name]	Turn quadruple-size mode on/off for Kanji characters			
[Format]	ASCII	FS	W	<i>n</i>
	Hex	1C	57	<i>n</i>
	Decimal	28	87	<i>n</i>
[Range]	0 ≤ <i>n</i> ≤ 255			
[Description]	Turns quadruple-size mode on or off for Kanji characters.			
	<ul style="list-style-type: none"> • When LSB of <i>n</i> is 0, quadruple-size mode for Kanji characters is turned off. • When LSB of <i>n</i> is 1, quadruple-size mode for Kanji characters is turned on. 			
[Notes]	<ul style="list-style-type: none"> • This command is valid only for Japanese Kanji model, Chinese Kanji model, and Taiwanese Kanji model. • Only the lowest bit of <i>n</i> is valid. • In quadruple-size mode, the printer prints the same size characters as when double-width and double-height modes are both turned on. 			
[Default]	<i>n</i> = 0			
[Reference]	FS !			

EPSON	TITLE	TM-U200 series Specification (STANDARD)	SHEET REVISION	NO.	
			I	NEXT 104	SHEET 103

6.5 Ignored Commands

The serial interface model ignores the following commands:

ESC c 3 n

ESC c 6 n

The parallel interface model ignores the following commands:

ESC c 6 n

EPSON	TITLE TM-U200 series Specification (STANDARD)	SHEET REVISION I	NO.	
			NEXT App.1	SHEET 104

APPENDIX A: MISCELLANEOUS NOTES

1) Print duty

- When printing exceeds the allowable print duty cycle, the printer automatically detects the print head temperature rise, stops logic-seeking, and enters full-column print head movement operation. This stops the temperature rise by lowering print duty. If the print head temperature continues to rise, the printer stops the print head. In this case, the user should be aware that the printing speed may slow significantly.
- When printing is stopped due to high print head temperature, the ERROR LED blinks as shown in Table 3.5.1.
- When the head temperature error occurs, the printer goes off-line. The printer automatically goes back on-line when the print head temperature falls.
- The upper limiting conditions on continuous printing are as follows. (An example test pattern is shown in Figure A-1 and Figure A-2.)

[Conditions] • Maximum continuous printing time: 1 hour

• Ambient temperature: 25°C (77°F)

• Number of line feeds:

Set the number of lines to be fed based on the following ratio:

A: ratio between printed lines and fed lines

$$A \leq \frac{15\text{-line printing}}{10\text{ lines fed}}$$

• Print head duty:

The number of print columns must be 20 or less in full-column print head movement operation.

• Print color selection:

Do not switch the print color frequently. When a black-red-black or red-black-red color selection sequence is regarded as 1 switching, the user should perform switching according to the shown below.

B: Print color switching rate

$$B \leq \frac{2\text{ switching}}{15\text{-line printing}}$$

2) Data transmission

Data should be transmitted after the printer power is turned on and initialize operation completes.

3) Manual cutter

The roll paper should be cut off after finishing paper feed. After cutting the roll paper, the paper should always be fed 6/144 inches before any subsequent print (to cancel the gear backlash).

4) Reverse paper feed

Normally, the printer can feed paper 1 line (including the gear backlash) in the reverse direction, when **ESC K** or **ESC e** is executed. However, do not perform reverse feed more than 48/144 inch (including the gear backlash).

EPSON	TITLE	TM-U200 series Specification (STANDARD)	SHEET REVISION	NO.	
			I	NEXT App.2	SHEET App.1

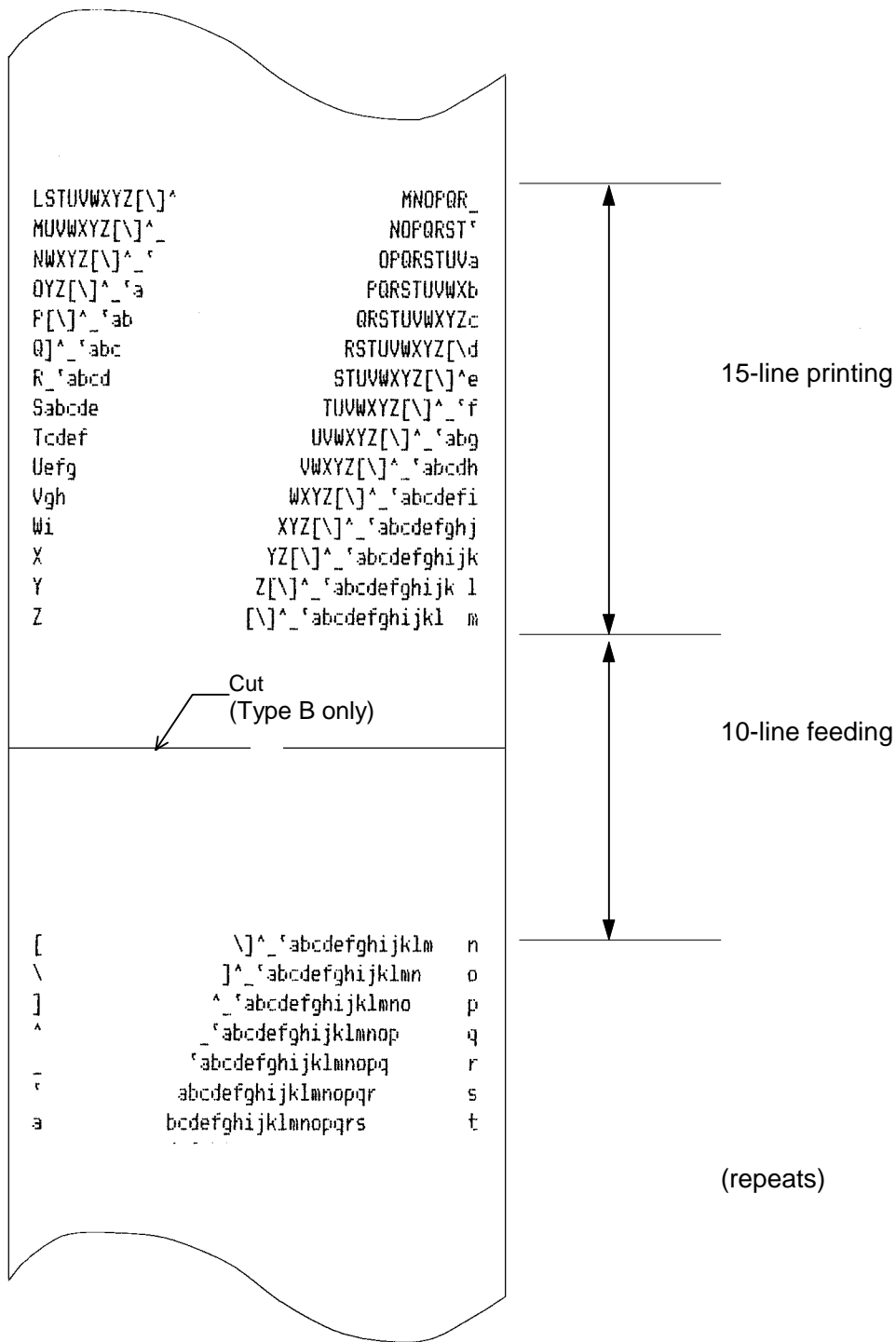
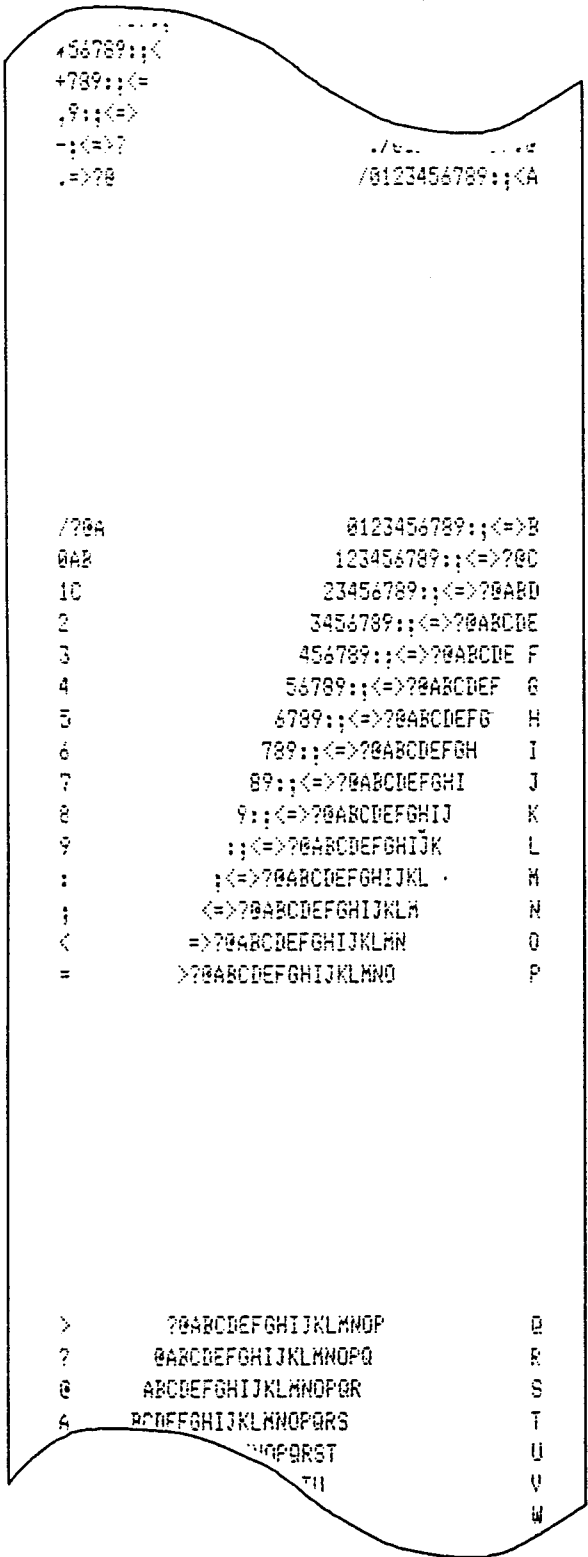

Figure A-1 Continuous Printing Test Pattern (Using the ERC-38(P)/(B))

EPSON	TITLE	TM-U200 series Specification (STANDARD)	SHEET REVISION	NO.	
			I	NEXT App.3	SHEET App.2



Print color
Black
Red
Black
"
"
"
"
Red
Black
"
"
"
"

Number of lines printed: 15 lines

Number of lines fed: 10 lines

(Repeated)

Figure A-2 Continuous Printing Test Pattern (Using the ERC-38(B/R))

EPSON	TITLE	TM-U200 series Specification (STANDARD)	SHEET REVISION	NO.	
			I	NEXT App.4	SHEET App.3

5) Manual operation of auto cutter

In paper jam, the printer may be stopped with the auto cutter blade not be in its normal position. In such case, insert the screw driver into the hole at the right side of the auto cutter as shown in Figure A-3, and turn the gear inside the cutter unit to move the cutter blade to its normal position.

6) Other note

Because this printer uses plated steel, the cutting edges may be subject to rust.

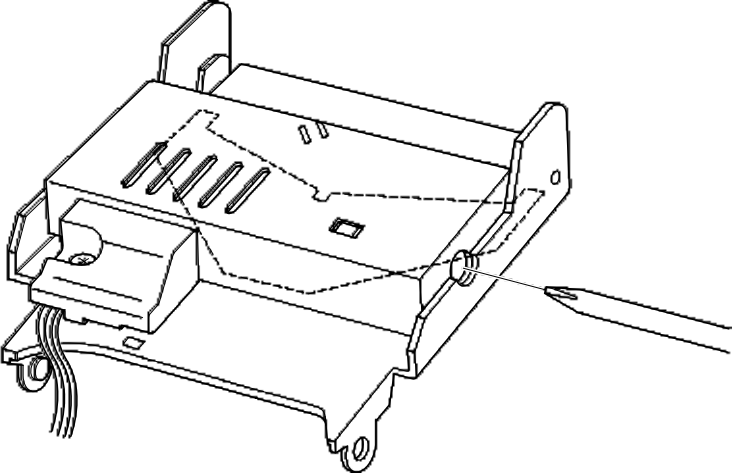

Figure A-3 Auto cutter

EPSON	TITLE TM-U200 series Specification (STANDARD)	SHEET REVISION 1	NO.	
			NEXT App.5	SHEET App.4

APPENDIX B: INSTALLING THE NEAR-END DETECTOR AND ADJUSTING THE AMOUNT OF ROLL PAPER REMAINING

The near-end detector is mounted in place on the printer case by using the mounting screw provided. Because the amount of paper remaining on a roll differs according to the inner and outer diameters of the core of the roll, the spacer provided can be used to adjust the amount remaining within the range indicated below. The spacer is tightened along with the tightening screws, as shown in the diagram below.

- 1) The inner diameter of the core should be from 10.5 mm to 12.5 mm. (Refer to section 1.4, "Roll Paper Supply Unit.")
- 2) Select the amount of adjustment needed, given the thickness of the core (including honeycomb cores).
- 3) The spacer can be used to set the amount remaining ("A"), including the thickness of the paper roll core.
 - * Honeycomb core: A core that resembles a honeycomb.

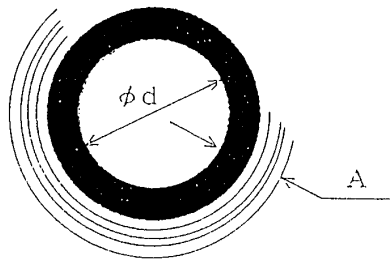

Spacer installed?	Dimension "A"
Yes	3 ~ 4 mm
No	6 mm

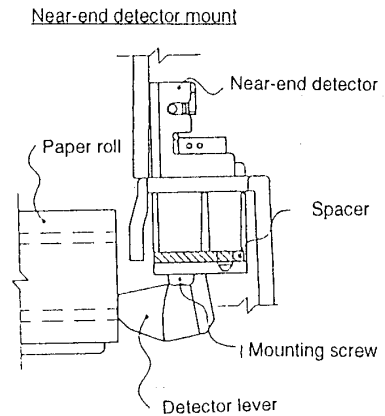

Notes:

1. Because the values listed for "A" in the table are calculated values, there may be some deviation among individual units.
2. When the last portion of a roll of paper bears red markings at the end, the marking is sometimes an adhesive that pulls the entire paper roll up. In this case, the values shown in the table above do not properly correspond to the amount of paper remaining.
3. After installing the near-end detector, make sure that the detection lever moves smoothly.
4. If the roll of paper easily comes loose due to the quality of the paper, etc., incorrect detection of the end of the paper may result.

EPSON	TITLE	SHEET REVISION	NO.	
	TM-U200 series Specification (STANDARD)	I	NEXT App.6	SHEET App.5

APPENDIX C: NOTES ON CHARACTER PRINTING

Applied for the user-defined characters and the following characters.

Font	Page	Character code
7 × 9	0	<B0>H, <B2>H
9 × 9	1	<E5>H, <E7>H
9 × 9	0	<B2>H

- 1) The printer deletes the right-most dots of a character during double-width mode, if another character follows.

If the characters shown above are double-width enlarged (dots exists on the right-most position), the right-most dots of the enlarged character are not printed as shown in the figure below.

Example: 7 × 9 font is selected

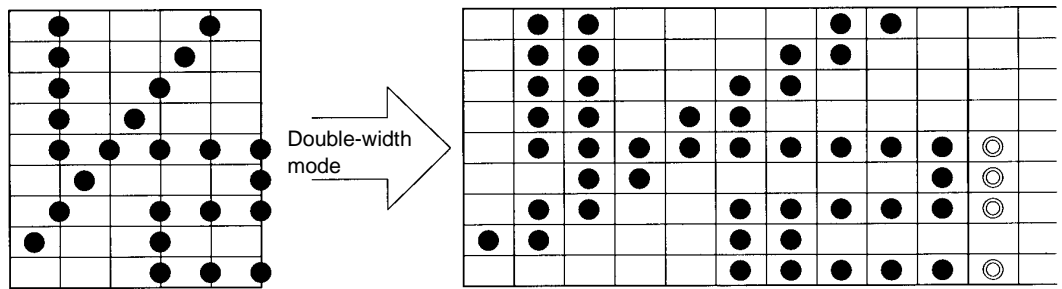

- ⊙ dots are not printed when another character follows.
- ⊙ Dots are printed when no character follows. (except ⊙ dots on 401st dot position)

Figure C-1 7 × 9 Font

- 2) The printer cannot print horizontally adjacent half dots. A special procedure that avoids horizontally adjacent half dots are used when print data is buffered in the print buffer. Therefore, some dots of the character that follows the characters prescribed above are not printed by the affect of the previous dots. Also, when the double-height mode is selected, the dots that affected by the previous dots are not printed as shown in the following figure because double-height processing is carried out during printing after the print pattern is buffered in the print buffer. To avoid this, program the software so that half dots are not adjoined horizontally. (E.g. set the right side spacing of character to 1 or more (**ESC SP**), etc.) In this case the user should note that the total number of dots in the horizontal direction is 400 dots.

EPSON	TITLE	TM-U200 series Specification (STANDARD)	SHEET REVISION	NO.	
			1	NEXT App.7	SHEET App.6

Confidential

Example: If the following codes are transmitted, some dots are not printed.
 (Graphic character H<B2> + "H" double-height enlarged)

```
PRINT #1, CHR$ (&HB2) ;
PRINT #1, CHR$ (&H1B);"!"; CHR$ (&H11);
PRINT #1, "H"; CHR$ ($HA) ;
```

When the data is buffered in the print buffer

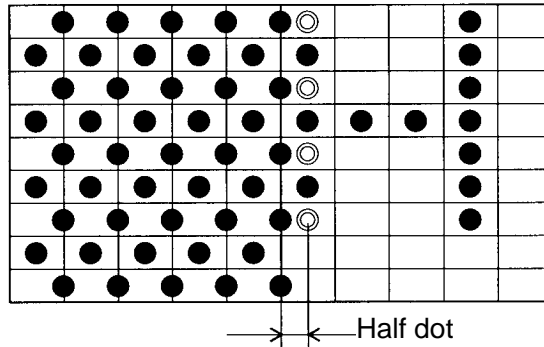

⊙ dots are deleted by the next character and not printed.

Printing result (unidirectional printing)

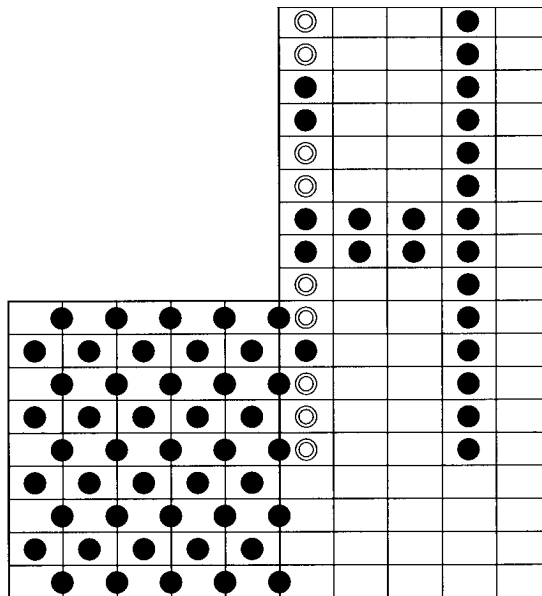

⊙ dots are not printed.

To avoid this, program the software as follows.

(Set the right-side spacing of graphic character (H<B2>) to 1.)

```
PRINT #1, CHR$ (&H1B) ;" "; CHR$(1) ; CHR$(&HB2) ;
PRINT #1, CHR$ (&H1B);"!"; CHR$ (&H11);
PRINT #1, "H" ; CHR$ ($HA) ;
```

EPSON	TITLE	SHEET REVISION	NO.	
	TM-U200 series Specification (STANDARD)	1	NEXT App.8	SHEET App.7

APPENDIX D: NOTES ON USING THE DRAWER KICK-OUT CONNECTOR

1) Drawer specifications (see Section 2.2.3, Drawer kick-out connector)

Drawer specifications differ significantly depending on manufacturer and model number. Make sure that the specifications of the drawer used meet the following conditions when connected to the drawer kick-out connector. These conditions also apply to any equipment (other than a drawer) that is connected to the drawer kick-out connector.

Never use a drawer (or other equipment) that does not meet all of the following conditions:

- The load, such as a drawer kick-out solenoid, must be connected between pins 4 and 2 or pins 4 and 5 of the drawer kick-out connector. (*1)
- When the drawer open/close signal (indicating the state of the drawer) is used, a switch must be provided between drawer kick-out connector pins 3 and 6. (*2)
- The resistance of the load, such as a drawer kick-out solenoid, must be 24 Ω or more or the input current must be 1A or less. (*3)
- Make sure to use the 24 V power output on drawer kick-out connector pin 4 for driving the equipment. Never connect any other power supply to the drawer kick-out connector. (*4) The peak current is 1 A. See item 2) below for drive signal duty.

- NOTES : (*1): Proper operation is not guaranteed with different connections.
 (*2): Proper operation is not guaranteed with different connections or connection to a component other than a switch.
 (*3): Connection to equipment whose resistance is 24 Ω or less or whose input current is 1 A or more may damage the connected equipment as well as the printer.
 (*4): Operation is not guaranteed with other power supplies.

2) Notes on the pulse generating command (**ESC p**)

When using **ESC p** to drive the drawer connected to the drawer kick-out connector, set the command parameters to meet the following conditions:

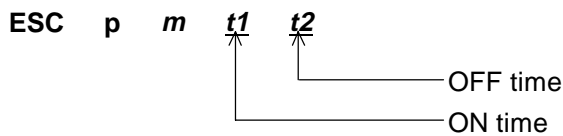

$$\frac{\text{ON time}}{\text{ON time} + \text{OFF time}} \leq 0.2 \dots\dots\dots \text{Formula D-1}$$

or, OFF time ≥ ON time × 4..... Formula D-2

EPSON	TITLE	TM-U200 series Specification (STANDARD)	SHEET REVISION	NO.	
			I	NEXT App.9	SHEET App.8

The drive signal waveform generated when the drawer is driven according to the above conditions is shown in Figure D-1.

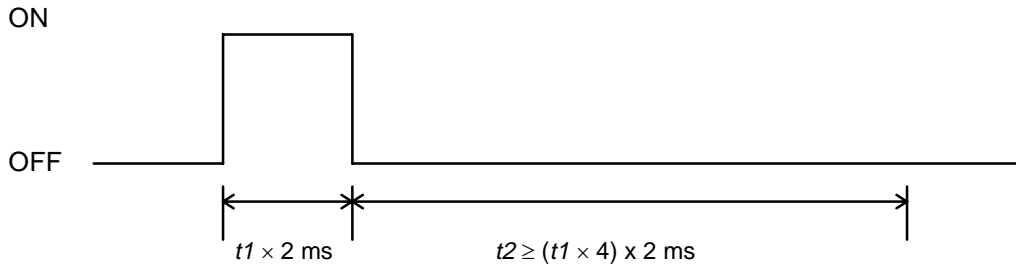

Figure D-1 Drawer Drive Signal Waveform (Formulas D-1 and D-2)

The ON time depends on the specifications of the drawer used. Be sure to check the drawer specifications and set a suitable time. To use a drawer that does not meet the conditions of Formulas D-1 and D-2, see the following section.

3) Using a drawer that does not meet the conditions in 2)

Setting the values of t1 and t2 according to the conditions in 2) results in a maximum ON time of 126 ms ($0 \leq t1 \leq 63$), since the setting ranges of t1 and t2 are 0 to 255. To use a drawer that requires an ON time exceeding 126 ms, the following conditions must be met:

$$\frac{\text{ON time}}{\text{ON time} + \text{OFF time}} \leq 0.2 \dots\dots\dots \text{Formula D-3}$$

α : other sequence processing time

NOTE: α is the drawer-driving prohibited period from the OFF time until the next ON time.

EPSON	TITLE	TM-U200 series Specification (STANDARD)	SHEET REVISION	NO.	
			I	NEXT App.10	SHEET App.9

Confidential

An example program in which the drawer connected to drive signal 1 is driven with an ON time of 200 ms is shown below.

```

PRINT #1, CHR$(&H1B);"p" ;CHR$(0);CHR$(100);CHR$(250);
GOSUB *WAIT300MS
    *WAIT300MS
    300[ms] wait routine (*1)
RETURN
    
```

ON time 200 ms OFF time 500 ms

*1 Corresponds to α of Formula D-3. Set the value so that it satisfies Formula D-3 (or include an internal processing time that is equal to or longer than this wait routine).

The drive signal waveform generated when the drawer is driven according to the above conditions is shown in Figure D-2.

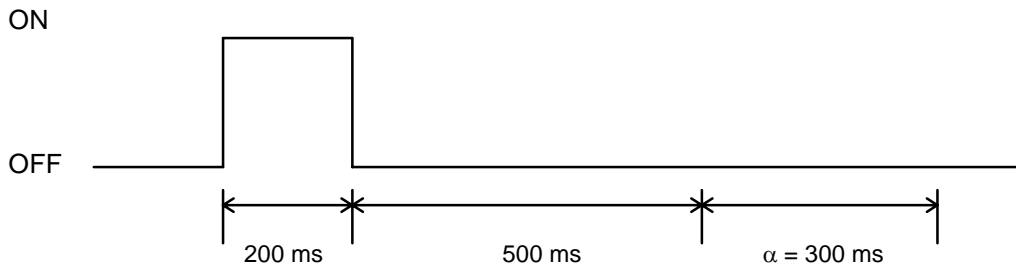

Figure D-2 Drawer Drive Signal Waveform

EPSON	TITLE	TM-U200 series Specification (STANDARD)	SHEET REVISION	NO.	
			I	NEXT App.11	SHEET App.10

APPENDIX E: TRANSMISSION STATUS IDENTIFICATION

The values of specific bits are fixed in the status information transmitted by the printer, so that the status bytes of commands can be identified. The user can therefore confirm the command to which the status belongs, as shown in the following table.

When using Auto Status Back (ASB), however, process the consecutive three-byte code (except for XOFF) as ASB data after confirming the first byte of the ASB. Otherwise, the status transmitted by using the **GS I** and the status of the second and following bytes of the ASB cannot be differentiated.

Table E-1 Transmission Status Identification

Command	Status Reply
GS I	<0**0****>B
GS r	<0**0****>B
XON	<00010001>B
XOFF	<00010011>B
DLE EOT	<0**1**10>B
ASB (1st byte)	<0**1**00>B
ASB (2nd byte - 4th byte)	<0**0****>B

EPSON	TITLE TM-U200 series Specification (STANDARD)	SHEET REVISION I	NO.	
			NEXT App.12	SHEET App.11

APPENDIX F: CONFIGURING THE SPACE PAGE

The space page is the character code table where character codes 80H to FFH are all undefined. This character code table is selected when n is set to 254 or 255 using the character code table selection command **ESC t n**.

1) Space page top address

Table F-1 Space Page Top Address

		Character page top Address	
Page	Character table	7 x 9	9 x 9
254	Space page	CBA0H	D5A0H
255	Space page	E1A0H	EBA0H

2) Calculating the character data top address.

The character data top address is calculate as follows:

- 7 x 9 font (graphics)
Character data top address = space page top address + (character code 80H) x 20
- 9 x 9 font (graphics)
Character data top address = space page top address + (character code 80H) x 24

3) Example font data configuration

- 7 x 9 font (using character code F0H on page 255)

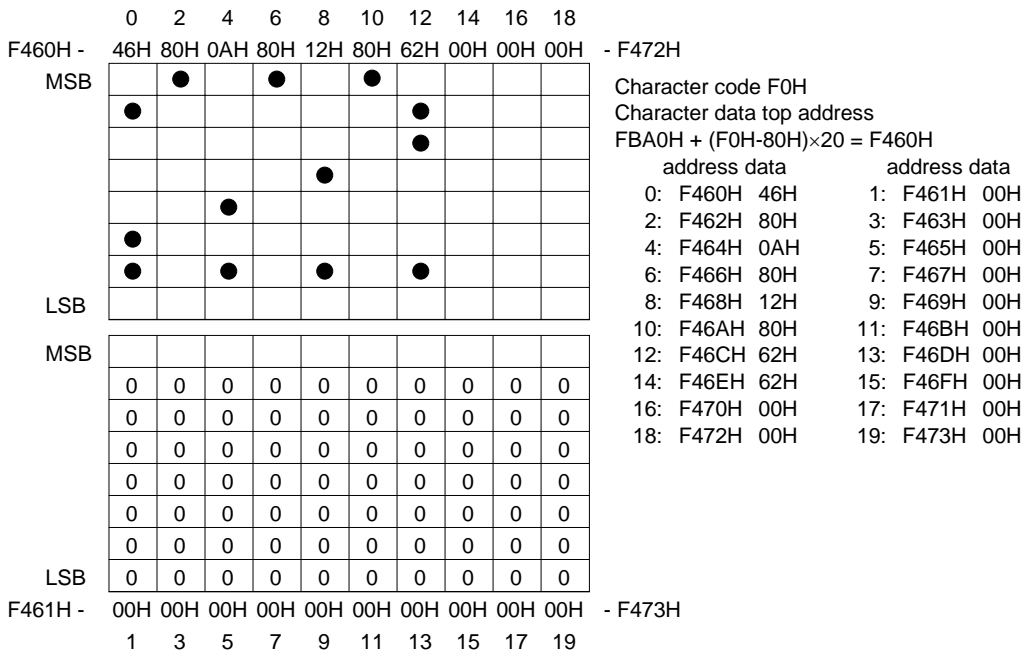

Figure F-1 7 x 9 Font

EPSON	TITLE	TM-U200 series Specification (STANDARD)	SHEET REVISION	NO.	
			I	NEXT App.13	SHEET App.12

- 9 x 9 font (using character code F0H on page 255)

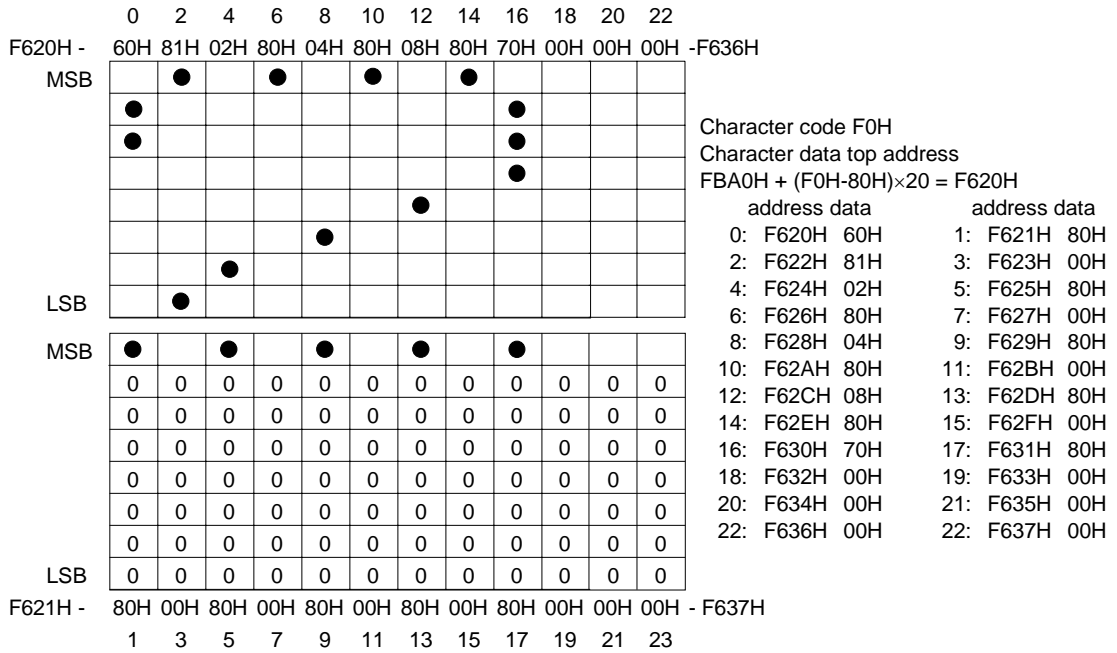
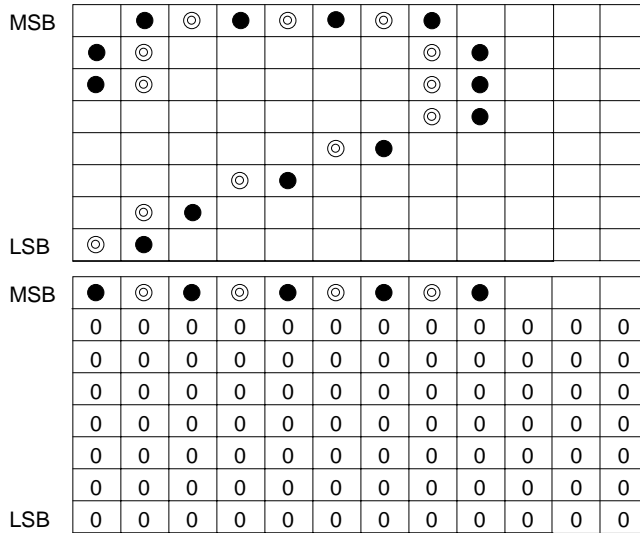

Figure F-2 9 x 9 Font

4) Notes

Do not use character patterns in which dots are horizontally adjacent.



The pattern shown above, in which ◎ and ● adjoin horizontally, is prohibited.

Figure F-3

EPSON	TITLE	SHEET REVISION	NO.	
	TM-U200 series Specification (STANDARD)	I	NEXT END	SHEET App.13